

CITY OF
SCOTTSDALE

DESIGN STANDARDS & POLICIES MANUAL

1-1 DESIGN STANDARDS & POLICIES MANUAL

PURPOSE OF THE DSPM..... 22
 1-1.000

ADOPTION & MODIFICATIONS TO DSPM 22
 1-1.100

CLARIFICATIONS, INTERPRETATIONS & APPEALS .. 23
 1-1.200

CONFLICTS..... 23
 1-1.300

1-2 DEVELOPMENT PROCESSES

GENERAL INFORMATION..... 25
 1-2.000

DEVELOPMENT PROCESSES 25
 1-2.100

 PRE-APPLICATION REQUIREMENTS28

 PRE-APPLICATION CONFERENCE.....28

 DEVELOPMENT APPLICATION SUBMITTAL & REVIEW29

 PUBLIC PARTICIPATION29

 DEVELOPMENT APPLICATION SUBMITTAL 29

 DEVELOPMENT PLANS.....29

 STAFF REVIEW30

 CITY COUNCIL, CITY BOARDS & COMMISSIONS.....30

NOTICE OF PUBLIC HEARINGS & MEETINGS..... 31
 1-2.200

APPEALS 32
 1-2.300

GENERAL LAND OFFICE EASEMENTS 32

1-2.400

FINALIZATION OF AN ABANDONMENT 34
 1-2.500

PERMITTING 34
 1-2.600

 DOCUMENT PREPARATION..... 34

 PLAN REVIEW APPLICATION 36

 CONSTRUCTION WORK ACTIVITY 39

 TEMPORARY FENCING 40

INSPECTIONS 43
 1-2.700

CERTIFICATE OF OCCUPANCY... 43
 1-2.800

BUILDING ADVISORY BOARD OF APPEALS 44
 1-2.900

1-3 CIVIL CONSTRUCTION DOCUMENT REQUIREMENTS

SUBMITTAL REQUIREMENTS 49
 1-3.000

DIGITAL SUBMITTAL & REVIEW . 49
 1-3.100

COVER SHEET..... 50
 1-3.200

AS-BUILTS 59
 1-3.300

REPORTS & OTHER DOCUMENTS 59
 1-3.400

DIRT HAUL/ENCROACHMENT PERMIT 59
 1-3.500

SOIL NAIL SHORING PERMIT
REQUIREMENTS..... 60
1-3.600

2-1 GENERAL CONSIDERATIONS & REQUIREMENTS

SCOTTSDALE SENSITIVE DESIGN PROGRAM + PRINCIPLES 64
 2-1.000

DESIGN GUIDELINES FOR SPECIFIC USES 64
 2-1.100

ADDITIONAL DESIGN GUIDELINES 65
 2-1.200

 SITE CONTEXT65

 TERRAIN65

 BUFFERING FOR ADJACENT LAND USES.....66

 AIRPORT & AIRPARK DEVELOPMENT.....66

 SITE DESIGN STANDARDS67

 UTILITY CABINETS, TRANSFORMERS AND PEDESTALS.....67

 SERVICE ENTRANCE SECTIONS68

 CITYWIDE EXTERIOR LIGHTING DESIGN GUIDELINES68

 OUTDOOR LIGHTING AMBIENT LIGHTING ZONES70

 BUILDING DESIGN STANDARDS.....73

 SUSTAINABLE SITE & BUILDING DESIGN73

ON-SITE CIRCULATION & PARKING AREA DESIGN 75
 2-1.300

 MAJOR DRIVEWAYS75

 GATED PRIVATE STREET AND DRIVEWAY ENTRANCES75

 EMERGENCY ACCESS & FIRE LANES.....78

 DRIVE-THROUGH FACILITIES.....80

 PARKING AREAS81

 CORRIDORS & STREETSCAPES86

 GARAGES AND CARPORTS.....89

 BICYCLE PARKING FACILITIES92

REFUSE COLLECTION.....93

PEDESTRIAN ACCESS ROUTE TO STREETS97

PEDESTRIAN ACCESS ROUTE TO MULTI-USE TRAILS97

PEDESTRIAN CIRCULATION WITHIN A DEVELOPMENT97

DRAINAGE FACILITIES 99
 2-1.400

 DETENTION BASINS..... 100

 SURFACE CHANNELS 101

 NATIVE PLANTS IN DETENTION BASINS & DRAINAGE CHANNELS 101

LANDSCAPE DESIGN..... 102
 2-1.500

 DESIGN STANDARDS 102

 IRRIGATION 105

SUBDIVISION & NEIGHBORHOOD DESIGN 105
 2-1.600

 STREET DESIGN..... 105

 BLOCK DESIGN..... 107

 PERIMETERS OF DEVELOPMENT 107

 SUBDIVISION ENTRIES 108

 LOT DESIGN 109

2-2 ENVIRONMENTALLY SENSITIVE LANDS

GENERAL INFORMATION 112
 2-2.000

UTILITIES 114
 2-2.100

 WATER DISTRIBUTION LINES..... 114

 SEWER DISTRIBUTION LINES 115

 PUBLIC LIFT STATIONS 115

 INDIVIDUAL SEWAGE EJECTOR SYSTEMS 115

 ON-SITE WASTEWATER TREATMENT 116

 MISCELLANEOUS UTILITIES 116

STORMWATER DRAINAGE PLANNING 117
 2-2.200
 IMPROVEMENTS TO NATURAL WASHES 117

ROADWAYS 120
 2-2.300
 GENERAL DESIGN FACTORS 120
 SPECIAL CONSIDERATION FOR ROAD CROSS-SECTIONS 121
 ROAD GRADING 122
 STREET INTERSECTIONS 124
 STREET LIGHTING 124
 SIDEWALKS 125
 BIKEWAYS 125
 DRIVEWAYS 125

SITE WORK 129
 2-2.400
 APPLICABLE PROJECTS 130
 EXEMPTIONS 130
 GEOTECHNICAL INVESTIGATIONS 130
 MAXIMUM GRADING AREA 131
 GRADING DESIGN GUIDELINES 131

SITE DESIGN GUIDELINES 135
 2-2.500
 GENERAL DESIGN GUIDELINES 135

MASTER DESIGN CONCEPT PLANS 149
 2-3.300

2-3 DEVELOPMENT PLANS & MASTER DEVELOPMENT PLANS

DEVELOPMENT PLANS 142
 2-3.100

DEVELOPMENT MASTER PLAN 144
 2-3.200
 DEVELOPMENT MASTER PLAN REQUIREMENT 144
 DEVELOPMENT MASTER PLAN APPROVAL 145
 DEVELOPMENT MASTER PLAN COMPONENTS 145

3-1 LAND USE

GENERAL INFORMATION..... 151
 3-1.000

LAND DIVISION TYPES 151
 3-1.100

SUBDIVISIONS..... 151
 3-1.200
 PRELIMINARY PLATS..... 151
 FINAL PLATS 154

MINOR SUBDIVISIONS 154
 3-1.300
 MINOR SUBDIVISION REQUIREMENTS 154
 IMPROVEMENT PLANS & FINAL PLATS 155
 LIMITATIONS 156

CONDOMINIUM PLATS 156
 3-1.400
 CONDOMINIUM PLAT PROCESS 156
 MODIFICATION OR CHANGE TO A
 CONDOMINIUM PLAT PROCESS 156
 GUIDELINES FOR REVIEW PROCESS..... 157
 CONDOMINIUM PLAT SUBMITTAL
 REQUIREMENTS 157

CHANGES TO A RECORDED LAND
 DIVISION 158
 3-1.500
 COMPLETE REVISION (MAJOR CHANGES) 158
 PARTIAL REVISION 159

LAND ASSEMBLAGE 159
 3-1.600

PUBLIC IMPROVEMENTS..... 160
 3-1.700
 INFRASTRUCTURE REQUIREMENTS 160
 PROPORTIONATE SHARE..... 163

ASSURANCE OF CONSTRUCTION. 163
 3-1.800
 ASSURANCE PROCESS..... 164

TYPES OF ASSURANCE 164
 ASSURANCE REDUCTION FOR WARRANTY
 PERIOD 164
 PLAT SUBMITTALS 166
 PLATS 166
 LAND SURVEYORS CERTIFICATION 169
 COVER SHEET 169
 PLAN SHEETS..... 170
 DEDICATION 175
 ACKNOWLEDGMENT 175
 RATIFICATION 176
 ACKNOWLEDGMENT 176
 CITY OF SCOTTSDALE COUNCIL PLAT APPROVAL
 177
 CITY OF SCOTTSDALE STAFF PLAT APPROVAL
 177

4-1 GRADING & DRAINAGE

GENERAL INFORMATION..... 179
 4-1.000
 GOVERNMENT AUTHORITIES..... 179
 STANDARDS 179
 RESOURCES..... 180

FLOODPLAIN MANAGEMENT 180
 4-1.000
 PERMIT REQUIRED 180
 SPECIAL FLOOD HAZARD AREAS 181
 SUBSTANTIAL IMPROVEMENT & DAMAGE IN SFHAS 182
 GARAGES IN SPECIAL FLOOD HAZARD AREAS 182

STORMWATER MANAGEMENT..... 183
 4-1.200
 STORMWATER STORAGE..... 184
 UNDERGROUND STORMWATER STORAGE POLICY..... 189
 STORMWATER STORAGE WAIVERS..... 191
 STREET DRAINAGE..... 192
 CHANNEL LINING..... 196
 CULVERTS & STORM DRAINS 196

STORMWATER MANAGEMENT..... 196
 4-1.300

STORMWATER QUALITY 197
 4-1.400
 CONSTRUCTION GENERAL PERMITS 197
 HOW TO OBTAIN STAFF & CITY APPROVAL 197
 OPERATIONAL REQUIREMENTS 198
 COMPLETING CONSTRUCTION 198
 SECTION 404 PERMITS..... 198
 ACTIVITIES REGULATED UNDER SECTION 404 198
 SECTION 401 CERTIFICATION 198
 COMPLIANCE REQUIREMENTS 198
 WASTE DISPOSAL SYSTEM LOCATIONS 199
 LOW IMPACT DEVELOPMENT 199

ACTIVITIES REQUIRING A DRAINAGE REPORT AND GRADING & DRAINAGE PLANS..... 199
 4-1.500
 TYPES OF REPORTS AND PLANS 199
 STANDARDS 201
 LIMITATIONS 201
 METHODOLOGY & CALCULATIONS..... 201

GENERAL EASEMENT INFORMATION 205
 4-1.600

PRELIMINARY GRADING PERMITS 206
 4-1.700

EXCESS SITE CONSTRUCTION SOIL 207
 4-1.800

**5-1 TRANSPORTATION
IMPACT STUDY**

GENERAL INFORMATION.....234
 5-1.000

INITIATING IMPACT AND
 MITIGATION ANALYSIS.....235
 5-1.100

 CATEGORY 1236
 CATEGORY 2236
 CATEGORY 3237

EXTENT OF STUDIES237
 5-1.200

 CATEGORY 2 STUDY237
 CATEGORY 3 STUDY238

CONTEXT & FRAMEWORK238
 5-1.300

 EXISTING CONDITIONS238
 HORIZON YEAR(S).....239
 PEAK TRAFFIC HOUR(S).....239
 BACKGROUND STUDY AREA DATA.....239
 REVIEW OF ANTICIPATED OFF-SITE CHANGES
240
 FIELD RECONNAISSANCE AND DATA
 COLLECTION.....240

NON-SITE TRAFFIC FORECASTS240
 5-1.400

SITE TRAFFIC FORECASTS.....241
 5-1.500

 GENERAL PROCEDURE.....241
 SOURCES.....241
 SELECTION OF TRIP GENERATION RATES OR
 EQUATIONS242
 CHOOSING THE APPROPRIATE TIME PERIODS
242
 DAILY AND SEASONAL VARIATIONS242
 DRIVEWAY TRAFFIC VS. TRAFFIC ADDED TO
 ADJACENT STREETS242

MULTI-USE PROJECTS.....242
 SPECIAL OR UNUSUAL GENERATORS243

SITE TRAFFIC DISTRIBUTION AND
 ASSIGNMENT.....243
 5-1.600

 DISTRIBUTION METHODS.....243
 TRIP ASSIGNMENT AND PASS-BY TRIPS244
 REDEVELOPMENT PROJECTS245

ANALYSIS245
 5-1.700

 TOTAL TRAFFIC ESTIMATE246
 GUIDELINES246
 IDENTIFICATION OF IMPACTS, NEEDS AND
 COMMON DEFICIENCIES246
 SAFETY.....250
 FORMULATION OF MITIGATIONAL
 ALTERNATIVES251

SITE ACCESS AND OFF-SITE
 IMPROVEMENTS251
 5-1.800

 ESTABLISHMENT OF GOALS.....251
 RECOMMENDATIONS252
 IMPLEMENTATION SCHEDULE252

ON-SITE CIRCULATION.....253
 5-1.900

 APPROACH TO SITE PLANNING.....253
 ON-SITE PLANNING PRINCIPLES253

TRANSPORTATION IMPACT
 MITIGATION ANALYSIS (TIMA)
 REPORT254
 5-1.1000

 PURPOSE AND END USES.....254
 PRESENTATION.....254
 CERTIFICATION255
 SAMPLE REPORT OUTLINE.....255

MASTER TRANSPORTATION SYSTEM
 PLAN256

5-1.1100

5-2 RIGHT-OF-WAY MANAGEMENT

GENERAL INFORMATION.....260

5-2.000

PERMIT REQUIREMENT.....260

5-2.100

WORK WITHOUT A PERMIT.....260

PURPOSE OF A PERMIT.....260

TYPES OF PERMITS.....260

EMERGENCIES.....261

ADDITIONAL REQUIREMENTS.....262

PERMIT PROCEDURES.....263

PERMIT DURATION.....263

PERMIT SUSPENSION, REVOCATION AND ENFORCEMENT.....264

INSURANCE FOR PERMITS.....264

5-2.200

PERMIT HOLDER LIABILITY AND INDEMNIFICATION.....264

GENERAL INSURANCE REQUIREMENTS.....264

GENERAL COVERAGE REQUIREMENTS.....265

MODIFICATIONS TO INSURANCE.....266

CITY RIGHTS, DISCLAIMERS AND RELIANCE ...266

TRAFFIC CONTROL PLANS267

5-2.300

UTILITY CONSTRUCTION PLAN267

5-2.400

WORK HOURS IN THE ROW.....267

5-2.500

ROW LICENSES AND LEASES268

5-2.600

WORK CLASSIFICATIONS.....268

STREET CLASSIFICATIONS.....268

RESTRICTIONS.....269

JOINT TRENCHING POLICY.....269

VACUUM EXCAVATION AND POTHOLING271

STREET BORING REQUIREMENTS.....271

UNDERGROUNDING REQUIREMENT271

BARRICADE PLAN.....271

CONSTRUCTION SIGNS.....273

COMMUNITY NOTIFICATION.....276

INSPECTIONS.....276

PAVEMENT CUTS.....276

STRIPING AND MARKING REQUIREMENTS276

TRANSIT FACILITIES AND AMENITIES.....276

ABANDONED FACILITIES AND FACILITIES REMAINING AFTER EXPIRATION OF PIR.....277

ALLEYS.....278

AS-BUILTS 278

5-2.700

5-3 GEOMETRICS

GENERAL INFORMATION 280

5-3.000

NATIONAL STANDARDS280

STREET TYPES.....280

STREET CLASSIFICATIONS.....281

DESIGN STANDARDS 282

5-3.100

MAJOR ARTERIALS.....282

MINOR ARTERIALS284

COUPLETS285

MAJOR COLLECTORS.....286

MINOR COLLECTORS287

LOCAL COLLECTORS.....289

LOCAL RESIDENTIAL291

LOCAL COMMERCIAL AND INDUSTRIAL.....292

LOW VOLUME STREETS.....292

SIDEWALKS294

PRIVATE STREETS295

LANE WIDTHS.....295

STREET RIGHTS-OF-WAY295

PAVEMENT CROSS-SECTION SLOPES.....	296	SPECIAL STANDARDS.....	334
MEDIANS	296	5-3.900	
CURBS.....	297	ESL STANDARDS	335
SIDE SLOPES	299	5-3.1000	
DESIGN SPEED	299	5-4 TRAFFIC SIGNAL DESIGN	
SUPERELEVATION IN CURVES.....	299	GENERAL INFORMATION	344
HORIZONTAL CURVES.....	300	5-4.000	
VERTICAL ALIGNMENT	302	DESIGN CRITERIA	345
COMBINED CURVES	303	5-4.100	
INTERSECTIONS.....	303	PROVISIONS.....	345
ROUNDBABOUTS.....	313	SIGNAL STRUCTURES.....	345
STREET ACCESS AND DRIVEWAYS	317	SIGNALS.....	346
5-3.2000		PEDESTRIAN SIGNALS	348
DRIVEWAY SPACING.....	317	CONTROLLER.....	348
DRIVEWAY LOCATIONS.....	319	CONTROLLER CABINET	349
VEHICULAR NON-ACCESS EASEMENT	319	CONSTRUCTION PLAN SUBMITTALS	
RESIDENTIAL DRIVEWAYS.....	319	352
NON-RESIDENTIAL DRIVEWAYS.....	320	5-4.200	
DECELERATION LANES.....	324	TRAFFIC SIGNAL PLAN CONTENT	353
BRIDGES, RETAINING WALLS, AND		5-4.300	
STRUCTURAL CLEARANCES.....	325	PLAN CONTENT	353
5-3.300		GENERAL NOTES	354
BRIDGES	325	CONSTRUCTION VEHICLE DETECTION.....	356
RETAINING WALLS.....	326	CIRCUITRY.....	356
STRUCTURAL CLEARANCES.....	327	5-4.400	
PARTIAL STREET IMPROVEMENTS	327	STRUCTURES.....	359
5-3.400		5-4.500	
CONSTRUCTION OF HALF-STREETS		5-5 SIGNS AND MARKINGS	
.....	327	GENERAL INFORMATION	364
5-3.500		5-5.000	
PAVEMENT TRANSITIONS.....	328	USE OF NATIONAL AND LOCAL STANDARDS	364
5-3.600		DESIGN STANDARDS	364
FRONTAGE ROADS	329	5-5.100	
5-3.700		SIGNING	364
SUBDIVISION STREET PLANNING..	330	STRIPING.....	366
5-3.800			

PLAN LAYOUT.....373
 5-5.200
 GENERAL REQUIREMENTS 373
 SIGNING 373
 STRIPING 374
 PLAN NOTES 374

5-6 TRANSIT

GENERAL INFORMATION.....377
 5-6.000
 BUS STOP SPECIFICATIONS 377
 ACCESSIBILITY 379

TRANSIT AMENITIES381
 5-6.100
 SHELTERS..... 382
 FURNITURE..... 384
 BUS BAYS (PULLOUTS) 385

LANDSCAPING.....386
 5-6.200

SIGNAGE387
 5-6.300
 BUS STOP SIGNS..... 387
 SIGN PLACEMENT 388
 SIGN CLEARANCES 389
 OTHER FACILITIES 389
 SUBMITTAL REQUIREMENTS AND REVIEW
 PROCESS 389

5-7 BIKEWAYS

GENERAL INFORMATION.....392
 5-7.000
 COMPONENTS OF BIKEWAY SYSTEM..... 392
 DOCUMENTS AND REFERENCES 392

PLANNING BIKEWAY SYSTEM393
 5-7.100
 LOCATIONS..... 393
 FACILITY SELECTION: ON-STREET..... 393
 FACILITY SELECTION: OFF-STREET 393

EASEMENTS, DEDICATIONS AND
 ABANDONMENTS 394

FACILITY DESIGNS 394
 5-7.200
 SHARED STREETS AND BIKE ROUTES 394
 BIKE LANES..... 395
 SHARED USE OR MULTIUSE PATHS..... 397
 RIDING SURFACES 403

TRAFFIC CONTROLS 404
 5-7.300
 SIGNS AND MARKINGS..... 404
 DETOURS AND CONSTRUCTION 406

BICYCLE PARKING 407
 5-7.400

**5-8 PUBLIC PEDESTRIAN
 FACILITIES**

GENERAL INFORMATION 409
 5-8.000
 REFERENCES 409

DESIGN GUIDELINES 410
 5-8.100

SIDEWALK WIDTH AND PEDESTRIAN
 ACCESS ROUTES 410
 5-8.200

SIDEWALK SURFACE, TEXTURE AND SLOPE... 410
 CLEARANCES 411
 PUBLIC REALM 411

DRIVEWAY CROSSINGS AND ACCESS
 MANAGEMENT 412

CURB RAMPS 413
 PHYSICAL SEPARATION FROM TRAFFIC..... 413
 LIGHTING 413

INTERSECTIONS 413
 SHADE 414

SEATING 414
 5-8.300

5-9 NEIGHBORHOOD TRAFFIC MANAGEMENT

GENERAL INFORMATION.....416
 5-9.000
 APPLICATION 416
 REFERENCES 416
 GOALS416
 5-9.100
 PROCEDURES417
 5-9.200

5-10 FLEXIBLE PAVEMENT

GENERAL INFORMATION.....419
 5-10.000
 DEPTH AND MIX REQUIREMENTS..... 419
 USE OF RECYCLED ASPHALT CONCRETE 419
 SOIL TESTING REQUIREMENTS419
 5-10.100
 SUBGRADE SAMPLING LOCATIONS..... 419
 TYPE OF TESTS 420
 PAVEMENT DESIGN REPORT 420

BASE COURSE FOR MINOR STREET
420

5-10.200
 BASE COURSE DESIGN CHARTS..... 420
 BASE COURSE SELECTION PROCEDURE 422

BASE COURSE FOR MAJOR STREET
422

5-10.300
 BASE COURSE DESIGN CHARTS..... 422
 BASE COURSE SELECTION PROCEDURE 423

DESIGN OF STRUCTURAL SECTIONS
423

5-10.400
 MODIFIED AASHTO DESIGN PROCEDURES FOR EXPRESSWAYS 423
 DESIGN PARAMETERS 424

PROJECTED TRAFFIC LOADING..... 426
 REGIONAL FACTOR 428
 STRUCTURAL FACTOR..... 428
 DESIGN PROCEDURE..... 428

5-11 STREET LIGHTING

GENERAL INFORMATION 431
 5-11.000
 GUIDELINES 431
 5-11.100
 STREET LIGHTING FOR DEVELOPMENTS..... 432
 5-11.200
 MATERIAL REQUIREMENTS 435
 5-11.300
 DESIGN REQUIREMENTS 438
 5-14.400

6-1 WATER

GENERAL INFORMATION.....458

6-1.000

ENVIRONMENTAL QUALITY REQUIREMENTS . 458

PRIVATE WATER COMPANIES 459

AGREEMENTS.....460

6-1.100

CREDIT AGREEMENTS..... 460

OVERSIZE AGREEMENTS..... 461

PAYBACK AGREEMENTS 461

WATER SERVICE AGREEMENTS..... 461

IN-LIEU PAYMENTS..... 461

DESIGN REPORTS.....462

6-1.200

PRELIMINARY BASIS OF DESIGN REPORTS 464

FINAL BASIS OF DESIGN REPORTS 465

ADDITIONAL INFORMATION..... 472

WATER FACILITIES.....473

6-1.300

WELLS 474

RESERVOIRS 474

BOOSTER PUMP STATIONS..... 474

TRANSMISSION & DISTRIBUTION SYSTEMS.....474

6-1.400

MATERIALS..... 475

SYSTEM LAYOUT 476

DEAD-END LINES 477

DESIGN FLOW & HEAD LOSS..... 478

SYSTEM FLOW TEST REQUIREMENTS & USE OF RESULTS 478

PRESSURE REQUIREMENTS 481

PRESSURE-REDUCING & REGULATING VALVES 482

FITTINGS 483

SHUTOFF VALVES 483

AIR RELEASE VALVES 484

THRUST RESTRAINT 485

ELECTRONIC MARKERS 485

PIPE COVER 485

WASH CROSSING 486

VERTICAL SEPARATIONS AND REALIGNMENTS 486

SERVICE LINES AND METERS 487

BACKFLOW PREVENTION & CROSS CONNECTION CONTROL..... 490

SAMPLING STATIONS 491

TRACT AND EASEMENT REQUIREMENTS 491

EASEMENT RELEASE/ABANDONMENT REQUIREMENTS 492

FIRE PROTECTION 493

6-1.500

FIRE FLOW REQUIREMENTS..... 493

HYDRANT LOCATIONS 494

PAVEMENT MARKERS 494

FIRE AND BUILDING SPRINKLER LINES..... 494

BUILDING SPRINKLER SYSTEM REQUIREMENTS 495

SPRINKLER SYSTEM DESIGN..... 495

FIRE DEPARTMENT CONNECTION 496

AUXILIARY STORAGE TANKS..... 496

FINAL PLANS PREPARATION..... 496

6-1.600

GENERAL REQUIREMENTS 496

SPECIFIC WATER PLAN REQUIREMENTS..... 497

REVIEWS AND APPROVALS..... 497

AS-BUILT DRAWINGS..... 497

7-1 WASTEWATER

GENERAL INFORMATION..... 500

7-1.000

EPA REGULATIONS 500

ADEQ REQUIREMENTS 501

PRIVATE WASTEWATER FRANCHISES..... 501

AGREEMENTS..... 502

7-1.100

CREDIT AGREEMENTS..... 503

OVERSIZE AGREEMENTS..... 503

PAYBACK AGREEMENTS 503

WASTEWATER SERVICE AGREEMENTS..... 503

IN-LIEU PAYMENTS..... 504

DESIGN REPORTS..... 504

7-1.200

PRELIMINARY BASIS OF DESIGN REPORTS 506

FINAL BASIS OF DESIGN REPORTS 507

ADDITIONAL INFORMATION..... 510

WASTEWATER FACILITIES..... 510

7-1.300

ON-SITE TREATMENT FACILITIES 510

LIFT STATIONS 510

FORCES MAINS 511

COLLECTION SYSTEM 512

7-1.400

MATERIALS..... 513

SYSTEM LAYOUT 514

DESIGN FLOWS..... 514

HYDRAULIC DESIGN..... 515

MANHOLES AND CLEAN OUTS 515

MONITORING VAULTS AND MANHOLES 517

PIPE COVER AND SEPARATIONS 518

DESERT WASH CROSSING 519

GRAVITY SEWER SERVICE CONNECTIONS..... 519

EJECTOR SEWER SERVICE CONNECTIONS 520

GREASE, OIL, AND SAND INTERCEPTORS..... 521

TRACT AND EASEMENT REQUIREMENTS 521

EASEMENT RELEASE OR ABANDONMENT
REQUIREMENTS 522

PRIVATE SEWER LINES..... 523

ALTERNATIVE SEWER SYSTEMS..... 523

INCIDENTAL CONNECTIONS 523

FINAL PLANS PREPARATION..... 523

7-1.500

SPECIFIC SEWER PLAN REQUIREMENTS 524

REVIEWS AND APPROVALS..... 525

AS-BUILT DRAWINGS..... 525

7-1.600

8-1 LANDSCAPED MEDIANS & ROWS

GENERAL INFORMATION.....528
 8-1.000

RECOMMENDED PLANTS529
 8-1.100
 DOWNTOWN AND URBAN CHARACTER 529
 SUBURBAN CHARACTER.....529
 TRANSITIONAL ARID CHARACTER.....532

LANDSCAPE GUIDELINES535
 8-1.200
 MAINTENANCE RESPONSIBILITY 535
 MEDIAN WIDTHS.....536
 PLACEMENT OF TREES AND SHRUBS 536
 TREES QUANTITIES AND SIZES 538
 GRADING 538
 DECOMPOSED GRANITE.....538
 BOULDERS.....539
 PLANT SELECTION 539
 HYDROSEEDING AND NATURAL AREA OPEN SPACE (NAOS) RESTORATION..... 539

IRRIGATION GUIDELINES539
 8-1.300
 GENERAL IRRIGATION DESIGN CRITERIA 540
 FINAL PLAN SUBMITTALS.....540

SIGHT DISTANCE.....540
 8-1.400

ALTERATIONS AND AS-BUILTS541
 8-1.500

SPECIFIC AREA DESIGN GUIDELINES541
 8-1.600

SCOTTSDALE GATEWAYS.....541
 8-1.700

MEDIAN INSPECTIONS.....541
 8-1.800

8-2 PARKS

GENERAL INFORMATION 544
 8-2.000
 PARK LOCATIONS544

PARK MASTER PLANS 544
 8-2.100
 MUNICIPAL USE MASTER PLAN APPROVAL PROCESS 544

PARK DESIGN..... 545
 8-2.200
 WALKWAYS.....545
 DRINKING FOUNTAINS.....545
 PLAYGROUNDS545
 SOFTBALL / BASEBALL FIELDS.....546
 SPORTSFIELD LIGHTING546
 COURT FACILITIES.....549
 IRRIGATION GUIDELINES549
 LANDSCAPING550
 CONSTRUCTION MATERIAL.....552
 SIGNAGE552
 PARKING552
 PUBLIC POOLS552
 DECORATIVE FOUNTAINS /S WATER FEATURES553

8-3 NON-PAVED TRAILS

GENERAL INFORMATION 559
 8-3.000
 REFERENCES559
 REFERENCES559

TRAIL DESIGN 560
 8-3.100
 DESIGN CONSIDERATIONS560
 TRAIL LOCATIONS.....562

TRAIL CLASSIFICATIONS..... 564
 8-3.200
 PRIMARY TRAILS.....564

SECONDARY TRAILS..... 565

NEIGHBORHOOD TRAILS..... 567

MINIMALLY IMPROVED / RUGGED TRAILS 568

TREAD CONSTRUCTION 569

8-3.300

VEGETATION CLEARANCE..... 573

SURFACE WATER CONTROL 573

SPECIAL STRUCTURES 578

ROAD CROSSINGS 585

TRAIL ACCESS FACILITIES 586

8-3.400

TRAIL SIGNS AND MARKERS..... 587

8-3.500

SIGN LOCATIONS 587

SIGN SPECIFICATIONS 587

INSTALLATION 588

DEVELOPER PROVIDED STANDARD 589

TRAIL MAINTENANCE 590

8-3.600

9-1 INFRASTRUCTURE PLAN REQUIREMENTS

GENERAL INFORMATION.....595
 9-1.000

SUBMITTAL REQUIREMENTS595
 9-1.100

PLAN SHEET NUMBERING AND SEQUENCING597
 9-1.200

PLAN SHEET NUMBERING AND SEQUENCING598
 9-1.300

COVER SHEET 598

NOTES, LEGEND AND KEY MAP SHEETS..... 599

QUANTITY SUMMARY SHEET 601

PAVING PLAN, PROFILE AND DETAIL SHEETS601
 9-1.400

SHEET FORMAT..... 601

HORIZONTAL GEOMETRICS..... 602

TOPOGRAPHY AND NOTATION 604

PROFILES AND GRADES..... 605

STORMDRAIN PLAN, PROFILE AND DETAILS SHEET 606

PROFILES FOR CATCH BASINS AND CONNECTING PIPE..... 608

IRRIGATION PLAN, PROFILE, AND DETAIL SHEETS 609

SANITARY SEWER PLAN, PROFILE AND DETAIL SHEETS..... 610

WATER LINE PLAN, PROFILE AND DETAIL SHEETS 612

TRAFFIC SIGNAL PLAN, SCHEDULE, AND DETAIL SHEETS..... 612

TRAFFIC SIGNING (TS) AND PAVEMENT MARKINGS..... 613

LANDSCAPE, LANDSCAPE IRRIGATION AND INTEGRATED SIGN PLAN 613

BRIDGE AND STRUCTURAL PLANS AND DETAILS 615

RIGHT-OF-WAY PLANS..... 616

9-2 FACILITIES PLAN REQUIREMENTS

GENERAL INFORMATION 625
 9-2.000

GENERAL REQUIREMENTS 625
 9-2.001

PLAN SHEET NUMBERING AND SEQUENCING..... 626
 9-2.100

DETAILED SHEET INFORMATION . 627
 9-2.200

9-3 CONSTRUCTION BID DOCUMENTS

GENERAL INFORMATION 634
 9-3.000

CONSTRUCTION DRAWINGS 634
 9-3.100

SPECIAL PROVISIONS / TECHNICAL SPECIFICATIONS..... 634
 9-3.200

BID SCHEDULE 635
 9-3.300

ESTIMATE OF PROBABLE COSTS .. 635
 9-3.400

10-1 NATIVE PLANTS

PROTECTED NATIVE PLANTS..... 637

10-1.000

NATIVE PLANT PERMITS..... 637

10-1.100

SUBMITTAL REQUIREMENTS 638

INSPECTIONS..... 640

ACTIONS ON APPLICATIONS..... 641

SAGUARO SALVAGE AND
TRANSPLANTATION 641

10-1.200

NON-PROTECTED PLANTS AND
TREES 642

10-1.300

11-1 FIRE

GENERAL INFORMATION.....	644
11-1.000	
OVERVIEW OF FIRE PROTECTION .	644
11-1.100	
CASE APPLICATION	645
11-1.200	
PLAN REVIEW AND PERMITTING...	645
11-1.300	
FIRE INSPECTION AND CERTIFICATE OF OCCUPANCY.....	646
EMERGENCY ACCESS & FIRE LANES	646
11-1.400	
WATER SUPPLY	647
11-1.500	
FIRE PROTECTION.....	647
11-1.600	
SIGNAGE	648
11-1.700	
WILDLAND BOUNDARY	649
11-1.800	
HIGH RISE CONSIDERATIONS.....	649
11-1.900	
DOWNTOWN.....	650
11-1.1000	

12-1 DISABILITY ACCESS

GENERAL INFORMATION.....652
 12-1.000

ACCESSIBILITY CODES652
 12-1.100

ACCESSIBLE FACILITIES ON PRIVATE
 PROPERTY652
 12-1.200

 BUILDING ENTRANCES..... 653

 WALKING SURFACES..... 653

 CURB RAMP DESIGN ON-SITE 653

 DETECTABLE WARNING SURFACES ON-SITE
 653

 DRIVEWAY ACCESS TO PUBLIC AND PRIVATE
 STREETS..... 654

 ACCESSIBLE PARKING SPACES 654

 PASSENGER LOADING AND DRIVE THROUGH
 FACILITIES..... 655

 ON-GOING BARRIER REMOVAL 655

 ALTERATIONS..... 655

ACCESSIBILITY IN PUBLIC RIGHTS-OF-
 WAYS AND EASEMENTS FOR PUBLIC
 ACCESS.....655
 12-1.300

 DETECTABLE WARNING SURFACES IN PUBLIC
 RIGHTS-OF-WAY..... 656

 SITE ACCESS..... 656

 MEDIANS 656

 SIGNALS 656

 TRANSIT STOPS..... 656

 PUBLIC PARKS AND TRAILS 657

CONSTRUCTION ACTIVITY657
 12-1.400

**ACRONYMS &
ABBREVIATIONS**

TABLE OF CONTENTS.....662
A&A-1.TOC

Chapter 1

INTRODUCTION

1

This chapter presents an overview of the City of Scottsdale's (city's) development process to assist design professionals in preparing plans and reports needed for project development. It identifies requirement for preparing improvement plans and documents to submit for city review and approval.

1-1 DESIGN STANDARDS & POLICIES MANUAL

1-2 DEVELOPMENT PROCESSES

1-3 CIVIL CONSTRUCTION DOCUMENT REQUIREMENTS

Section 1-1

DESIGN STANDARDS & POLICIES MANUAL

1-1

This section provides a general overview of the purpose, adoption, modification, and interpretation of the Design Standards & Policies Manual (DSPM). It also covers appeals from decisions regarding the DSPM.

PURPOSE OF THE DSPM

1-1.000

The DSPM is one of the official documents setting forth city design guidelines, requirements, standards, policies, and procedures to enable development professionals to bring a development concept to fruition, including preparing plans, reports and related documents necessary to meet city standards. The city does recognize that some development projects have significant site constraints, and flexibility in some of the DSPM requirements, standards, policies and procedures may be allowed with limitations. The DSPM supports the goals of the Scottsdale General Plan and the requirements of Scottsdale Revised Code by providing technical standards and policies that are utilized for implementation of those goals and requirements.

This manual consists of twelve chapters which are: site planning; land divisions; grading and drainage; transportation; water; wastewater; streetscapes, parks and trails; public works and facilities; native plants; fire; and disability access. The information is generally presented in a sequence that parallels developing a tract of land from site planning and platting, to grading and development.

ADOPTION & MODIFICATIONS TO DSPM

1-1.100

A. Adoption

This manual has been adopted by a Resolution of the Development Review Board (DRB) under the authority delegated to it by the City Council (Section 48-5 of the

Scottsdale Revised Code (SRC)), in its current form on January 18, 2018. The DRB's Resolution with one paper copy and one electronic copy of the DSPM are maintained on file with the City Clerk.

B. Modifications

The DRB may adopt modifications to DSPM by Resolution.

CLARIFICATIONS, INTERPRETATIONS & APPEALS

1-1.200

Appeals, Clarifications, and Interpretations

- A. The individual chapters of the DSPM incorporated provisions related to several different chapters of SRC. A request for appeals, clarifications, and interpretations of a requirement of the DSPM may be submitted in accordance with the applicable chapter of the SRC as it pertains to the provision. E.g. an appeal of water service requirement of the DSPM is submitted and processed in accordance with Chapter 49 – Water, Sewers and Sewage Disposal; and, an appeal of a refuse provision is submitted and processed in accordance with Chapter 24 – Solid Waste Management.
- B. The chapters and appendixes of the SRC that are related to the provisions contained in DSPM are:
 - C. Chapter 5 – AVIATION
 - D. Chapter 20 – PARKS, RECREATION AND CULTURAL AFFAIRS
 - E. Chapter 24 – SOLID WASTE MANAGEMENT
 - F. Chapter 31 – BUILDINGS AND BUILDING REGULATIONS
 - G. Chapter 36 – FIRE PREVENTION AND PROTECTION
 - H. Chapter 37 – STORMWATER AND FLOODPLAIN MANAGEMENT
 - I. Chapter 46 – PLANNING, DEVELOPMENT AND FEES
 - J. Chapter 47 – STREETS, SIDEWALKS AND PUBLIC WORKS GENERALLY
 - K. Chapter 48 – LAND DIVISIONS
 - L. Chapter 49 – WATER, SEWERS AND SEWAGE DISPOSAL
 - M. APPENDIX B – BASIC ZONING ORDINANCE

CONFLICTS

1-1.300

If there is a conflict between the SRC and the DSPM, the SRC shall govern.

Section 1-2

DEVELOPMENT PROCESSES

1-2

This section provides details of the city's development process which normally includes a pre-application conference, development application, construction document review and permits, temporary construction fencing, inspections and issuance of a certificate of occupancy (C of O). It includes information about the city's public hearing process and public notification requirements.

GENERAL INFORMATION

1-2.000

The Planning and Development Services Department mission is, “To work together to build and maintain Scottsdale as a great community.” To accomplish the community’s vision and values, which are then reflected in the built environment, the city utilizes community involvement, zoning and technical codes and review processes for implementation. Refer to Figure 1-2.1 below.

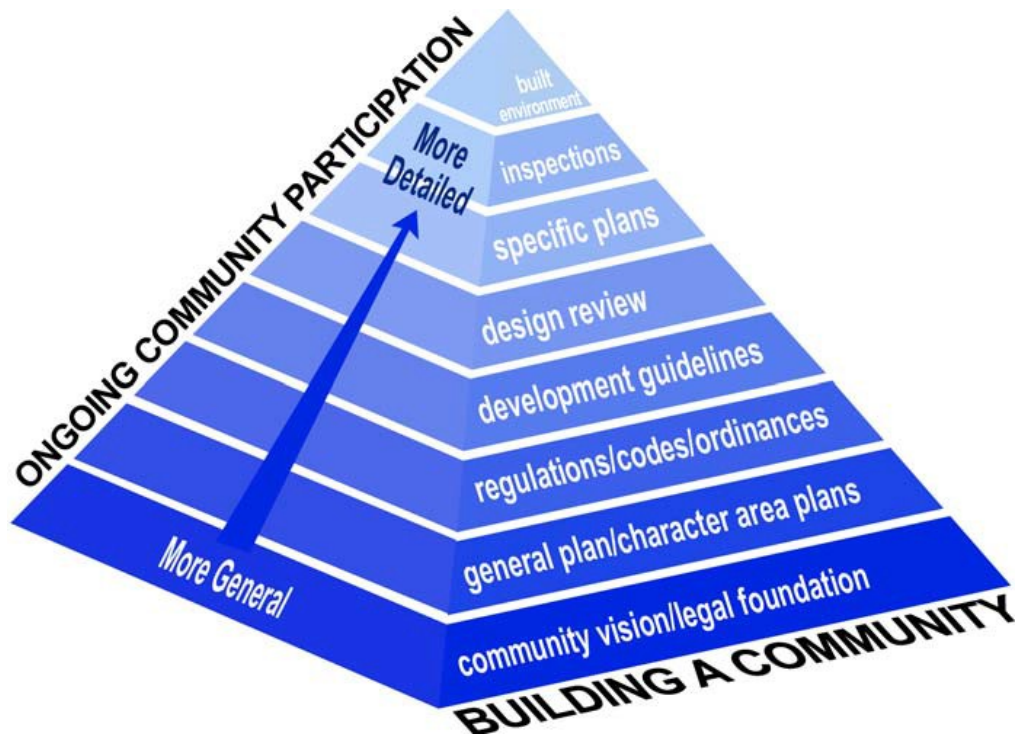

FIGURE 1-2.1 COMMUNITY DEVELOPMENT PYRAMID

DEVELOPMENT PROCESSES

1-2.100

Land development in Scottsdale typically involves five steps as shown in Figure 1-2.2 below. Fewer steps may be necessary for a less complicated project such as an individual single-family residential (R1-) dwelling or one eligible for a minimum building permit.

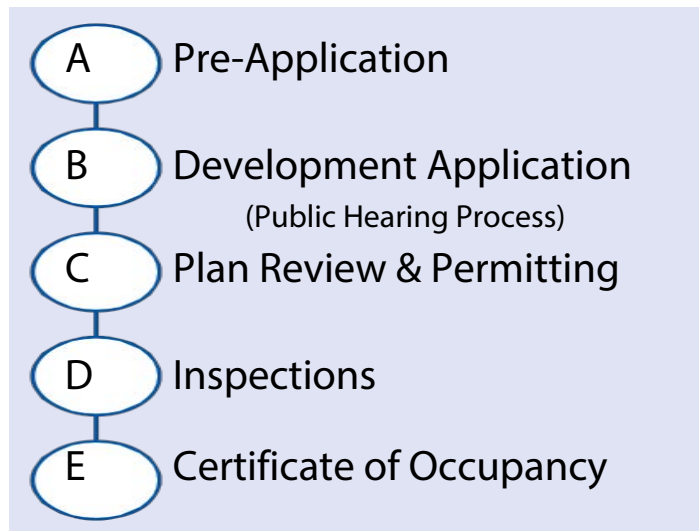

FIGURE 1-2.2 SCOTTSDALE DEVELOPMENT PROCESS

A. Pre-application conference:

Most development activities begin with the submittal of a pre-application conference request to the city. The primary purpose of the pre-application conference is for staff to help identify the scope of the development proposal, so that the city can determine the appropriate submittal requirements and process(es). Refer to Table 1-2.1 for projects requiring a pre-application conference and Section 1-2.200 for a discussion of the pre-application process.

B. Development application submittal and review:

After submission of a complete development application, approval may be achieved through the public hearing process. Refer to Section 1-2.104 for the community notification and involvement requirements necessary before submitting a complete development application. Once these requirements have been met and a complete development application has been accepted, the development proposals must go through specific review processes that are identified in Table 1-2.1. Most all processes are dictated by the SRC. The development of a detached individual single-family home that complies with current zoning district development standards may proceed with construction document review and permits; all other development proposals must complete the application submittal and review process before submitting for construction document review and permits.

C. Application for construction document review and permits:

This step consists of preparing and submitting construction documents for review and obtaining permits for construction activities. Refer to Section 1-2.400.

D. Inspections:

All permitted construction activities must be inspected by the city's inspection services staff. Refer to Section 1-2.500 for inspection information. Occasionally, development applications that do not require the issuance of a permit, may require an inspection by the city's project coordinator, plan review staff, or inspection services staff.

E. Certificate of Occupancy and Certification of Shell Building:

The Certificate of Occupancy (C of O) or Certification of Shell Building is issued in accordance with the city’s adopted building and fire codes once the city has determined that all requirements have been satisfied.

TABLE 1-2.1 DEVELOPMENT APPLICATION APPROVAL PROCESSES							
PROJECT TYPE	OTHER PROCESSES		PUBLIC HEARING PROCESSES				
	PA	SA	BOA	PC	CC	DRB	HPC
Abandonment	x			x	x		
Amended Development Standards	x			x	x	*	
Amended Development Standards: Preliminary Plat (PP)	x					x	
Amended Stipulations	x			x	x	*	
Annexation	x			x	x		
Character Area Plan Amendment	x			x	x		
Commercial Repainting	x	*				*	
Community Sign District	x					x	⊗
Condominium Plat		x				*	
Development Plans	x	*		*	*	*	⊗
Development Master Plans	x	*				*	⊗
Environmentally Sensitive Lands (ESL) Overlay Hardship Exemption	x				x		
General Plan Amendment	x			x	x		
Land Assemblage		x					
Master Sign Plan	x					x	⊗
Minor Amendment ¹	x						
Minor Subdivision	x	x				*	
Municipal Use Master Site Plan	x			x	x	x	
New Construction - Major	x					*	⊗
New Construction - Minor	x	*				*	⊗
Perimeter Exception	x				x	x	
Plat (Preliminary Plat)	x					x	
Plat (Final Plat)					x		
Release of Easement		x					
Text Amendment	x			x	x		
Use Permit (UP)	x			x	x		
Wash Modification (ESL)	x	x					

TABLE 1-2.1 DEVELOPMENT APPLICATION APPROVAL PROCESSES							
PROJECT TYPE	OTHER PROCESSES		PUBLIC HEARING PROCESSES				
	PA	SA	BOA	PC	CC	DRB	HPC
Wireless Communication Facility	×	*		*	*	*	
Zoning District Map Amendments ²	×			×	×	*	*
Zoning Variance	×		×				
* Staff will determine at the pre-application conference whether which administrative and public hearing processes will be required. ☒ Staff will determine at the pre-application conference whether an application on a lot with Historic Property overlay zoning may require the approval or recommendation of the HPC, or whether the application has no effect, and may be approved by Staff. 1. The Minor Amendment process is specified in the Zoning Ordinance 2. Includes development plans required as part of a Zoning District Map Amendment.				PA = Pre-Application SA = Development Review Board - Minor (Staff Approval) BOA = Board of Adjustment PC = Planning Commission CC = City Council DRB = Development Review Board HPC = Historic Preservation Commission			

PRE-APPLICATION REQUIREMENTS

1-2.101

The specific pre-application submittal requirements vary by application type. Refer to the [Pre-Application Request](#) form. All pre-applications require the following:

- A. Completed Pre-Application Request form
- B. Pre-application fee
- C. Application narrative

Typical additional requirements may include:

- A. Context Photos
- B. Conceptual plans
- C. Records packet (aerial photo, water & sewer maps, and a zoning map)
- D. Records packet fee
- E. Material colors and samples

PRE-APPLICATION CONFERENCE

1-2.102

The pre-application conference between city staff and the applicant to discuss a proposed development application typically lasts 30 to 60 minutes. Staff will usually contact the applicant to schedule the pre-application conference within one week of receipt of the pre-application request. In general, the pre-application conference is scheduled within two to three weeks of the receipt of the pre-application request. Information exchanged at the pre-application conference allows city staff and the applicant to come to a more complete understanding of the size, scope and feasibility of the proposal.

Based on the discussion at the conference, the proposal will be processed in one of three ways. The city’s project coordinator will:

- A. Determine if the application is may be processed administratively or require a public meeting/hearing to obtain a decision on the application once submitted.
- B. Provide the applicant with the appropriate development application checklist(s) and any related information; or
- C. Require additional information to be submitted, and a subsequent pre-application conference to be conducted for further review.

DEVELOPMENT APPLICATION SUBMITTAL & REVIEW

1-2.103

The development application submittal and review process consist of submitting a development application to the City and obtaining review of the development proposal. This may include a pre-application, public participation, administrative decision, or a recommendation and subsequent decision from one or more of the following public hearing bodies: Board of Adjustment, City Council, DRB, Historic Preservation Commission, and/or Planning Commission. Refer to Table 1-2.1 for the specific review processes. Depending on the purpose of the development application, additional public hearings may be required. These may include a recommendation or decision by the Airport Advisory Commission, Floodplain Board, Parks and Recreation Commission, McDowell Sonoran Preserve Commission or Transportation Commission.

The development of a detached individual single-family home that complies with current zoning district development standards may proceed with construction document review and permits; all other development proposals must complete the application, public participation, submittal and review process before submitting for construction document review and permits.

PUBLIC PARTICIPATION

1-2.104

The city has three public participation policies (Neighborhood Involvement, Citizen Review, and Neighborhood Notification). At the pre-application conference, city staff will determine which public participation policy applies based on the scope and scale of the development application and provide the applicant with the appropriate checklist and requirement.

The goal is to encourage public participation prior to the filing of a development application. Additional notification may be required for the public hearing process pursuant to state statutes and the Zoning Ordinance. Refer to Appendix 1-2A.

DEVELOPMENT APPLICATION SUBMITTAL

1-2.105

At submittal meeting, city staff will verify that all items on the development application checklist that was provided at the pre-application meeting are included with the development application submittal material and meet the minimum submittal requirements before the development application will be accepted for review. Incomplete applications will not be accepted for review.

DEVELOPMENT PLANS

1-2.106

Several zoning districts require Development Plans (DPs) to be submitted with a Zoning District Map Amendment development application. Refer to [Zoning Ordinance](#) requirements. In addition to the Zoning Ordinance requirements, city staff may

require additional Development Plan (DP) elements. The general description of DP elements that are typically required is in Chapter 2.1 of the DSPM.

STAFF REVIEW

1-2.107

- A. After review of a development application, staff will notify the applicant with the following:
 1. List of issues to be resolved before any public hearing/meeting date is set; or
 2. Public hearing/meeting date.
- B. After review of a development application that requires only an administrative decision, staff will notify the applicant with the following:
 1. List of issues to be resolved before a decision will be made on the application; or
 2. A written decision on the application.
- C. Timeframes
 1. Refer to the [City's Substantive Policy Statements and Staff Review Timeframes for Development Applications](#).
 2. Each year the city publishes a [General Plan amendment](#) timeframe for major amendments.

CITY COUNCIL, CITY BOARDS & COMMISSIONS

1-2.108

The City Council and the city's various boards and commissions perform a variety of functions under the authority of the SRC. Not limited to applicable processes identified in Table 1-2.1, a development application may require a recommendation or decision from one or more of the following:

- A. **Airport Advisory Commission**
The purpose of the Airport Advisory Commission is to advise the City Council on aviation-related issues and other matters set forth in Chapter 5, Aviation, of the SRC, including noise issues, airport safety and limited development applications within the vicinity of Scottsdale Airport.
- B. **Board of Adjustment (BOA)**
The purpose of the BOA is to make decisions on Zoning Ordinance variance requests, decisions and interpretation of the Zoning Administrator, and other matters set forth in the Zoning Ordinance.
Table 1-2.1 lists the most common development applications reviewed by the BOA.
- C. **City Council**
Table 1-2.1 lists the most common development applications reviewed by the City Council.
- D. **Development Review Board (DRB)**
 1. The purpose of the DRB is to make design decisions on certain development review applications and other matters set forth in the Zoning Ordinance.
Table 1-2.1 lists the most common development applications reviewed by the DRB.
 2. The Zoning Administrator may review and decide certain minor development review applications as set forth in the Zoning Ordinance.

E. Floodplain Board

The City Council serves as the Floodplain Board to make decisions on appeals and variances as set forth in Chapter 37, Stormwater and Floodplain Management, of the SRC. For additional information, refer to Chapter 37. The Floodplain Board meets on an “As Needed” basis.

F. Historic Preservation Commission (HPC)

The purpose of the HPC is to advise Planning Commission and the City Council in all matters concerning historic and archaeological preservation, and other matters set forth in the Zoning Ordinance.

Table 1-2.1 lists the most common development applications subject to HPC review.

G. Parks and Recreation Commission (PRC).

The purpose of the PRC is to advise the City Council on parks and recreation issues, and other matters set forth in Chapter 20, Parks, Recreation and Cultural Affairs, of the SRC.

The most common development applications reviewed by the PRC are Municipal Use Master Site Plans and Conditional Use Permits (CUPs) that affect park and recreation facilities.

H. McDowell Sonoran Preserve Commission (MSPC).

The purpose of the MSPC is to advise the City Council on matters related to the Preserve as set forth in Chapter 21, McDowell Sonoran Preserve, of the SRC.

The most common development applications reviewed by the MSPC are Municipal Use Master Site Plans and CUPs for the facilities within the McDowell Sonoran Preserve (typically trailheads and related improvements).

I. Planning Commission (PC).

The purpose of the PC is to act as an advisory body to the City Council on land use, zoning, and other matters set forth in the Zoning Ordinance, Section 1.601.

Table 1-2.1 lists the most common development applications reviewed by the PC.

The [precise schedule](#) for each board, commission, and City Council meeting vary each month.

NOTICE OF PUBLIC HEARINGS & MEETINGS

1-2.200

State law and the SRC govern a majority of notification requirements for Development Applications that are heard at a public hearing/meeting. The type of notification required varies by Development Application and hearing/meeting type. The city's requirements are identified in Table 1-2.1 and Appendix 1-2A. Please Note: The city has established policies that are in some cases more rigorous than required by state law. For additional information, applicants and the public should contact the Development Application's city project coordinator or call the Planning and Development Services Division at 480-312-7000.

The city may use the following methods for hearing notification:

- A. Posting a sign on the subject property
- B. Postcards to property owners of particular addresses
- C. [Case Fact Sheets](#)
- D. Legal Notices published in the newspaper

APPEALS

1-2.300

Please refer to Chapter 3 of the DSPM pertaining to a property owner's right to appeal a dedication or exaction.

GENERAL LAND OFFICE EASEMENTS

1-2.400

The Government Land Office (GLO) roadway easements were created by the Federal Small Tract Act (1938) to assure legal access for future street planning by prohibiting the building of any structures across these easements. The city has viewed these patent roadway and utility easements as assured access at least until a local circulation plan is established. As GLO lots come in for development (such as minor subdivisions, subdivisions, or requesting building permits) staff requires city rights-of-way dedications per city circulation plans.

Any patent easement in excess of the current circulation plan requirements (including trails) and roadway standards that are not required to insure access to any other lot, may be requested to be abandoned. GLO roadway easements go through the same process as the public roadway abandonment; only the public rights are abandoned in a Resolution approved by City Council. See Figure for GLO Easements in the city. The city's abandonment of a GLO easement does not include any determination of private rights; similar to other private easement rights, those are matters between property owners.

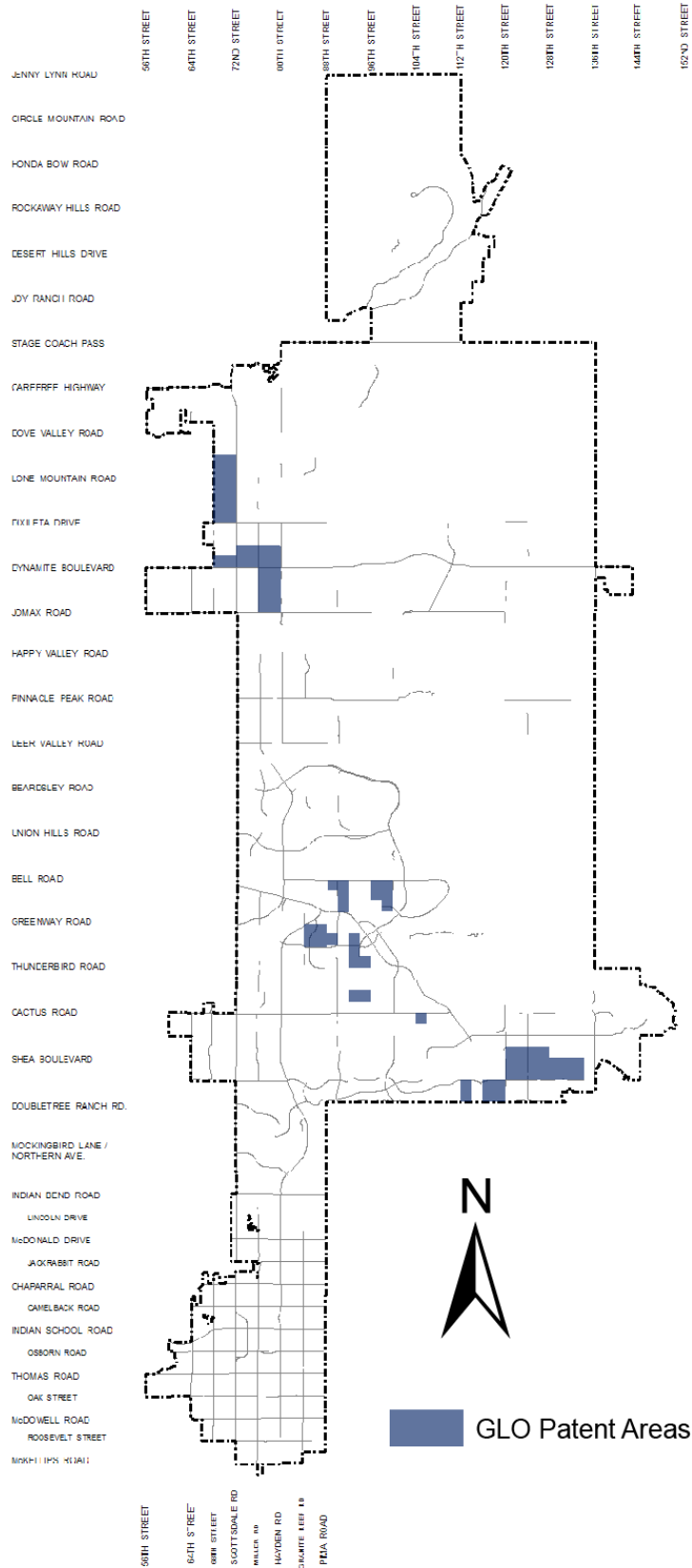

FIGURE 1-2.3

FINALIZATION OF AN ABANDONMENT

1-2.500

If the City Council approves the abandonment and adopts the abandonment resolution of the request without stipulations, the resolution will be sent to the Maricopa County Recorder's office for recordation. The recordation of the resolution legally abandons the city's public interest in the property (as authorized by State Statutes). Occasionally, the City Council will require specific requirements in the form of stipulations that are to be met prior to the recordation of the abandonment. The applicant has one year to complete all stipulations of the approval, otherwise the approval expires. If an approval expires, the applicant must process a new abandonment request – including the payment of fees for a new application if they still desire the abandonment. The recordation of the resolution is the final step in the public roadway abandonment process. A copy of the recorded document may be obtained from the City Clerk's Office or the Maricopa County Recorder's office after recordation.

PERMITTING

1-2.600

To ensure compliance with the SRC and to safeguard the health, property, safety, and welfare of the public, the city requires the approval of construction documents, including any associated maps, reports and related documents, for most development and construction activity within the City. In addition to the approval of the construction documents, the SRC requires the issuance of a Building, Permission to Work in the Right-of-way, or when applicable a Permission to Place Private Improvements in the Right-of-way permit for most all development and construction activities.

Maintenance and minor modifications to existing structures may not require the approval of construction documents or the issuance of permits, as determined by the Building Official, and in limited situations, the Zoning Administrator or the Historic Preservation Officer.

DOCUMENT PREPARATION

1-2.601

Construction Document Resources

A. [City Checklists, Forms, Guidelines, and other documents.](#)

The content requirement of each construction document plan, land division map, include reports, etc., is application specific. In addition to the applicable chapter(s) and section(s) of the DSPM and the SRC, the city provides checklists, details, forms, guidelines, notes, reference material, tables, and worksheets (calculations, examples, etc.) to assist applicants in the preparation of an application for a permit and plan review to be submitted for review by the City. It is the applicant's responsibility to provide all necessary information to demonstrate compliance with the SRC, the DSPM, and applicable checklists, guidelines, notes, reference material, tables, and worksheets.

1. Refer to the [Building Code, Fire Code and the city amendments](#) for information pertaining to construction activity that requires building permits.

2. Refer to Chapter 5 of the DSPM for information pertaining to construction activity that requires Permission to Work in the Right-of-way permit, and when applicable a Permission to Place Private Improvements permit (commonly referred to as encroachment permits).
 3. Refer to the Zoning Ordinance and the SRC for information pertaining to a native plant permit or sign permit.
- B. [City of Scottsdale Standard Construction Document Plans and Details](#).
The city provides standard construction document plans and details for small/simple construction activity, such as: residential patios, carport enclosures, detached garages, masonry fences/walls and retaining walls. A complete list of standards
- C. [Standard Construction Document Sheets and Details for the city's Public Works Construction](#)
Refer to Chapter 9 of the DSPM for information regarding the city's standard construction document sheets and details for the city's public works construction. These sheets and details are not part of this City's Supplement to Maricopa Association of Governments (MAG) Standard Details & Specifications.
- D. [MAG Uniform Standard Specifications and Details for Public Works Construction](#)
MAG sponsors and distributes the Uniform Standard Specifications and Details for Public Works Construction, which in addition to the City of Scottsdale Supplement to MAG Specifications and Details (COS MAG Details) are the basis for most public works construction and improvements in the public right-of-ways, easements and on public property in the city.
- E. [COS MAG Details](#) are typically updated on an annual basis. These supplements are the basis for most public works construction and improvements in the public right-of-ways, easements and on public property that is unique to the City. These details and specifications are available on the city's website in Portable Document Format (PDF) and DWG electronic file formats.
- F. The [City of Scottsdale's Green Building Program](#) encourages a whole-systems approach through design and building techniques to minimize environmental impact and reduce the energy consumption of buildings while contributing to the health of its occupants. The program is intended to enhance the sustainability of our built environment in the context of the Sonoran Desert and greater southwest region. In most applications, compliance with the programs is voluntary. The compliance with the program may become mandatory as a stipulation for a Zoning District Map Amendment, or part of development agreement when development bonuses are granted for floor area, building height or density.
1. Single family residence
The International Residential Code and guidelines and checklists development by the city are the bases for compliance with the city's Green Building Program pertaining to the development of single family residential structures.
 2. Non-single family residential
The City Council has adopted the International Green Construction Code (IGCC), including the city's amendments, to serve as the compliance mechanism for the city's Green Building Program pertaining to the

development of non-single family residential structures. Refer to the city's website at www.scottsdaleaz.gov/green-building-program.

G. Disability Access and Accessibility

Developers adhering to the accessibility standards of Chapter 12 of the DSPM, with a few exceptions, conform to city requirements.

PLAN REVIEW APPLICATION

1-2.602

A. **Submittal**

1. Unless otherwise required, any of the following construction document and land division map plan review applications for permitting may be submitted directly to the Planning and Development Services Division's One-Stop-Shop for review:
 - a. Affidavit of Correction.
 - b. Removal of a City Covenant.
 - c. Single-family detached dwelling(s) and its associated accessory structures.
 - d. Interior tenant improvements.
 - e. Miscellaneous modifications to any existing structure, or improvements that does not require the approval of a Development Review application, as determined by the Zoning Administrator.

The contents of the construction documents, maps, reports, and other data shall include all information necessary to demonstrate compliance with the SRC, including any amendments to the Building Codes and Fire Codes, interpretations, DRB approval, the applicable provisions of the DSPM, and any applicable county, state, and federal requirements.

Lot preparation for a single-family dwelling(s) and associated accessory structures that includes grade cuts and fills greater than four (4) feet for property subject to the Hillside District (HD) zoning district and eight (8) feet for property subject to the Environmentally Sensitive Land (ESL) zoning district (ESL zoning district), and subdivision infrastructure, grading and common structures typically requires the approval of a Development Review development application prior to the submittal of a permit and plan review application.

Online minimum permits may be obtained only for single family residences, and are limited to specific application types such as repairing a broken waterline or gas line, water heater replacement, etc. Minimum Permit Applications may be submitted online at city's website at eservices.scottsdaleaz.gov/bldgresources/Plans.

For additional information regarding a construction document and land division map permit and plan review application, refer to the city's website at www.scottsdaleaz.gov/planning-development.

2. Unless specified in A.1., the submittal of a construction document or land division map permit and plan review applications may be made after the approval of a Development Review development application. After the approval of a Development Review development application, the city will provide the property owner or agent with the Construction Document and/or a Land Division Map Application Requirements submittal checklist.

The contents of the construction documents, maps, reports, and other data shall include all information necessary to demonstrate compliance with the SRC, Development Review approval, the applicable provisions of the DSPM, and any applicable county, state, and federal requirements.

3. The submittal of the construction document and land division map permit and plan review application is to be made at the city's Planning and Development Services Division's One-Stop-Shop. The city does not accept submittal of applications that are mailed or shipped to the City.

B. [Electronic Application & Submittal](#)

To assist with the permit and plan review application submittal process, the city allows the applicants:

1. To complete an electronic application (e-application)
2. To submit digital documents for plan review in PDF format.

C. [Property Address](#)

A valid city address(es) is required for property that has submitted a Construction Document and Land Division Map Permit and Plan Review Applications. An address provided by the United States Postal Service is insufficient. To verify or obtain a valid city address(es), please contact the [Planning and Development Services Division's One Stop Shop](#).

D. [Review Timeframes](#)

Depending on the complexity of the construction document permit and plan review application, some applications may be reviewed over-the-counter. More complex construction document permit and plan review applications will be logged into the city for a subsequent review. Land division map and related permit and plan review applications are not reviewed over the counter.

E. [Approval Expirations](#)

1. Unless otherwise specified by the Building Code and its associated amendments, a permit and plan review application or approval is valid for 180 days from the date that the city notifies the applicant of the status of the application.
2. Additional review fees will be required, and the Building Official may require new construction documents or land division maps, if an applicant does not within 180 calendar days of the date that the city provides notice to the owner or agent regarding the status of the requested permit and plan review application resubmit the construction documents or land division maps for review, or obtain the applicable Building, Permission to Work in the Right-of-way, and Permission to Place Private Improvements permit.
3. The Building Official may grant a one-time extension up to a maximum of 180-days for a permit and construction document plan review application, or approval depending on the relationship of the plans to the current codes and depending on whether or not any required DRB approval has expired. The reinstatement of a permit and plan review application that has expired shall be subject to current standards and requirements.

F. Application Fees

1. Construction document and land division map permit and plan review applications fees are outlined in the city's fee schedule. Typically, fees are adjusted each July, 1st.
2. If the permit and plan review application expire, an additional fee is required to reinstate the application as calculated below:
Building permit application.
 - a. If within 6 months of the expiration date, the fee is half of the original application cost, unless otherwise specified in the city's amendments to the Building Code; or
 - b. If beyond 6 months of the expiration date, a re-application and the full application fee are required, unless otherwise specified in the city's amendments to the Building Code, based on the current fee schedule.
3. Permission to Work in the Right-of-way, and when applicable Permission to Place Private Improvements application:
Full application fee is, based on the current fee schedule.

G. Permit Issuance

1. Once a permit and plan review application are approved, the property owner or authorized agent may obtain the Building, Permission to Work in the Right-of-way, and when applicable a Permission to Place Private Improvements permit at the One Stop Shop. Contractors, and in limited situations property owner acting as an "Owner Builders", are required to have a valid city Transaction Privilege (sales) Tax License. When required, Contractors shall provide a valid Arizona Registrar of Contractors (ROC) license number.
2. The permit and permit inspection card shall remain on site for inspection at all times. Failure to produce the required permits will result in immediate suspension of all work until the proper permit documentation is obtained.

H. Revocations

The Building Official and the Zoning Administrator are authorized to suspend or revoke an approval or permit wherever the approval or permit is issued in error, or on the basis of incorrect, inaccurate or incomplete information, or in violation of any SRC or regulation.

I. Decision Interpretation or Clarification

The request to clarify an interpretation or application of an ordinance or code shall be submitted on the Request for Clarification or Interpretation of statute, ordinance, code, policy statement, including a Request for an Interpretation of the Zoning Ordinance form, and shall include applicable information. All requests shall be submitted to the Planning and Development Services Division's One Stop Shop to the attention of the appropriate authority of the applicable code or policy, such as the Zoning Administrator, Building Official, Floodplain Administrator, etc.

J. Appeals

Applicants that desire to appeal a decision made on a construction document and land division map permit and plan review application shall submit the appeal to the Planning and Development Services Division's One Stop Shop on the applicable forms, and in accordance with the provisions of the applicable SRC that

pertains to the request. For example, an appeal of the Building Code and its amendments shall be submitted in accordance with applicable sections of that Code.

CONSTRUCTION WORK ACTIVITY

1-2.603

A. Construction Work Activity Hours

Unless otherwise specified in the city's Building Code and associated amendments, the allowed start and required stop, with exceptions, for construction activity shall comply with the following:

1. Summer hours.

Summer hours shall begin April 1st and shall be in effect through October 31st. No work shall commence prior to 6:00 a.m. nor continue after 7:00 p.m., Monday through Friday. Work on Saturday and Sunday shall be restricted to 7:00 a.m. through 7:00 p.m. Sunday work shall only be conducted when the applicant demonstrates in writing justifiable cause for this work.

2. Winter hours.

The remaining portion of the year not designated as summer hours shall be winter hours. No work shall commence prior to 7:00 a.m. nor continue after 5:00 p.m. Monday through Friday. Work on Saturday and Sunday shall be restricted to 8:00 a.m. through 5:00 p.m. Sunday work shall only be conducted when the applicant demonstrates in writing justifiable cause for this work.

3. Variances in the hours of construction work activity

Unless otherwise specified in the city's Building Code and associated amendments, the Building Official may, upon written request, grant a variance from these times if just cause can be demonstrated that work must be done outside the prescribed time period (e.g. pouring concrete during summer hours). A variance shall not be granted based solely on convenience. A variance shall not be granted to any work that can be completed during daytime construction hours. The variance shall state the permit number, address, type of work, time period of the work, and the duration of a variance. The Building Official shall receive any requests for variance at least seven days before the work by the variance is started. Variances shall not be granted for more than 30 days at a time. If a longer timeframe is necessary additional applications shall be made for those occurrences.

The city may establish other times as necessary based on the geographical location of the job site in relation to surrounding occupancies, buildings and structures.

B. Construction Debris and Alleys

It is unlawful to use the alley for disposal of construction debris or to cover/damage the surface of the alley in any way. It is illegal to place cement, dirt or any other construction debris in alleys or in any city refuse container. The city recommends the following practices:

1. Contain all construction waste (dirt, cement, etc.) away from the alley surface and arrange for proper disposal.
2. Do not use the alley to clean out cement mixers and/or other tools.

3. Remove (sweep and hose off) any dirt or other material that may spill in the alley.
4. Leave the alley in pre-construction condition when construction is complete.
5. Inspection Services will inspect the condition of the alley during all phases of construction. Failure to comply with these requirements may result in:
 - a. A "Stop Work Order" being issued until the project is brought into compliance and the alley restored to its original condition.
6. Issuance of a citation for illegal dumping and/or failure to properly maintain the alley in accordance with the Scottsdale Revised Code.
7. Best Practices for managing construction debris include:
Protect the alley surface by placing roofing paper, plywood, and landscaping fabric, etc. along the fence line.
8. Contain all construction debris inside the fence line.
9. Remove debris immediately after construction is completed.
10. Do not clean out cement mixers and/or tools in the alley.
11. Do not block the alley at any time.
12. In the event construction waste (dirt or cement, etc.) is not contained away from the alley:
Remove all large debris and haul it away.
13. Sweep any dirt, cement or gravel off the treated portion of the alley.
14. Hose off any remaining dirt, cement, or gravel from the treated portion of the alley.
15. Return the portion of the alley along the fence line to its original condition and grade.

TEMPORARY FENCING

1-2.604

Temporary fencing shall be installed in accordance with the following:

A. Screening

Unless otherwise required by the Building Code, or the Planning and Development Services General Manager or designee, temporary fencing on construction sites visible from a public or private street shall include semi-opaque screening on the side of the fence adjacent to the public or private street.

1. Screening made of fabric and/or vinyl shall be attached on all sides to the outside of the temporary fencing fence.
2. Fabric and/or vinyl screening shall be partially transparent with a woven denier no less than eighty percent (80%).
Half hemisphere slits with a maximum radius of one (1) foot may be provided in the screening to allow air to pass through. The half hemisphere slits shall have a minimum separation of six (6) feet. Other slits and holes shall not be made in fabric and vinyl screening.
3. Temporary fence screening in the environmentally sensitive lands ordinance designated areas shall be a dark green or dark brown color.
4. Other than for an individual single-family dwelling (and related individual lot improvements), the Planning and Development Services General Manager or designee may approve temporary fencing fence screening that may contain

development images of the building elevations, site plan, and landscape plan that were approved by the DRB.

Applicants that desire to utilize development images on all, or part of the screening shall submit a staff approval application to the Planning and Development Services. Applications shall include:

- a. Application and narrative,
 - b. A dimensioned site plan showing the location of all improvements (new and to remain), easements, intersection & driveway sight distance, traffic safety triangle, the location of the temporary fencing fence and screening, etc.,
 - c. Dimensioned color elevations of the proposed fence, screening, and development images, and
 - d. Total square feet of the screening and total square feet of the proposed images.
5. Upon review of the application, the Planning and Development Services General Manager or designee may approve, deny, or require correction to be made to the application to receive approval.
6. Access openings in the temporary fencing shall be protected by doors/gates with screening.

B. Location, signage, and identification

The temporary fence location and signage or identification attached to the temporary fence or on the screening shall comply with the requirements of the Zoning Ordinance, and the following:

1. Temporary fencing to be erected in the public right-of-way, private roads, and/or across public access sidewalks shall be provided in accordance with the [City of Phoenix Barricade Manual](#) and the [Manual on Uniform Traffic Control Devices](#), and shall be subject to the approval of the Transportation General Manager or designee.
2. Temporary fencing proposed to enclose or prohibit access to a public transit stop, shall be subject to the approval of the Transportation General Manager or designee.
3. Temporary fencing proposed to be erected in a traffic safety triangle and/or intersection and driveway sight distance triangle shall be subject to the approval of the Transportation General Manager or designee.
4. Unless required by the building official or designee, temporary fencing shall not enclose a fire hydrant. A temporary fence adjacent to a fire hydrant shall be set back a minimum of a five-foot radius distance from the fire hydrant.
5. All emergency access points shall be marked with a sign in compliance with the Fire Department requirements; see Section 11-1.700 and Figure 11-1.1.
6. Emergency access identification, access identification, safety identification, visitor check-in and identification as required by the Occupational Health and Safety Organization and/or the Building Code may be attached to the fencing only on both side of an entrance for 10 feet, or in locations required by the Planning and Development Services General Manager or designee.

7. Locations of traffic control identification attached to the temporary fencing shall be subject to the approval of the Transportation General Manager or designee.
8. Access openings in the temporary/security fencing shall be protected by doors/gates with screening.
9. A temporary fence shall not be provided on property(ies) that has a temporary sales trailer, model home complex, and any associated parking.

C. Vacant Sites and/or Vacant Buildings

A temporary/security fence provided on a vacant site and/or around a vacant building:

1. Shall have a maximum height of three-feet.
2. May consist of posts or bollards with wire or chain connecting the posts or bollards.
3. May not have more than three horizontal members.
4. May not be located in right-of-way, roadway easements, or roadway tracts.
5. Shall comply with the setback and location requirements of the Zoning Ordinance.

Applications for temporary/security fence provided on a vacant site shall include:

- a. Application and narrative,
 - b. A dimensioned site plan showing the location of all improvements (new and to remain), easements, intersection & driveway sight distance, traffic safety triangle, the location of the temporary/security fence and screening, etc. and signs required in Section 1-2.407, paragraph B5b, and
 - c. Details of the fencing.
6. A vacant site shall be posted with at least one no littering or dumping sign in accordance with Figure 1-2.4 on the following page.

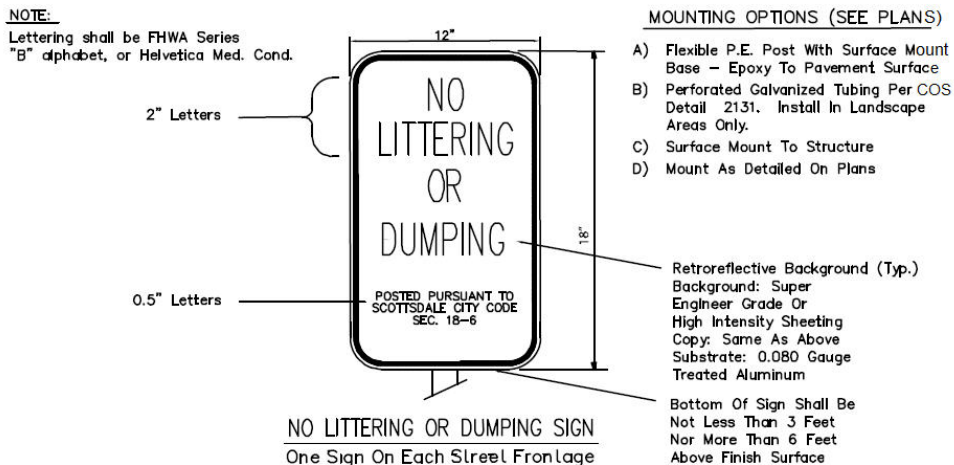

FIGURE 1-2.4 NO LITTERING OR DUMPING SIGN

D. Special Events

Temporary/Security fencing required for a special event permit shall be provided in accordance with the requirements determined by the city's special events committee.

E. Construction Sites

Unless otherwise required by the Building Code, or the Planning and Development Services General Manager or designee, a construction site shall be enclosed with a temporary/security fencing that is a six (6) foot high chain link fence. An alternative to the chain link fence requires the approval of the Planning and Development Services General Manager or designee.

The location of a fence is to be shown on the site plan or a separate fence plan that also identifies the location of all improvements (new and to remain), easements, intersection and driveway sight distance, traffic safety triangle, etc.

Fencing provided in the environmentally sensitive lands ordinance designated areas also must identify the color of the screening on the site plan.

INSPECTIONS

1-2.700

Inspections are made for building, electrical, mechanical, plumbing, and zoning compliance for residential, commercial and industrial development, and for the remodeling of existing buildings. Water, sewer, paving, concrete and grading activities also require city inspection. As part of the development process all permitted construction activities must be inspected by the city's Inspection Services staff. The review of plans and issuance of permits do not authorize code or ordinance violations that may be discovered by city inspectors at the job site.

A. Scheduling or Canceling an Inspection

The Inspection Job Card, received at the time of permit issuance, must be posted on the job site with an approved set of plans for the inspector's use. All construction, including foundations, electrical rough wiring, etc. must be inspected before any completed work is covered or concealed.

Inspections can be scheduled or canceled in several ways:

1. [Online](#)
2. By calling Inspection Services at 480-312-5750.

Using these systems also requires the key code printed on the permit receipt.

B. Estimated Time of Arrival

To determine the estimated time of an inspection, call 480-312-5750 and have the permit number or address available so staff can direct the call to the appropriate inspector. Only the assigned inspector can provide the estimated time of arrival.

CERTIFICATE OF OCCUPANCY

1-2.800

A. Issuance of Certificate of Occupancy (C of O)

Before any development can be occupied or used, an applicant must apply for a [C of O](#). Additionally, all DRB stipulations must be complied with before the city will issue a Certification-of-Shell Building or a final C of O. Typically, within three staff working days of submitting an application, the C of O or Certification of Shell

Building will be issued, provided the project passes a Final Inspection. The issuance of a C of O shall not be construed as an approval of a violation of the provisions of any city code or ordinance.

The city's building code requires certain information to be included on the C of O. Most important is the project address; the code also requires the name of the owner of the property at the time the certificate was issued. The C of O stays with the property for in perpetuity, even with changes in ownership. If the property ownership changes during construction, documentation of that fact can be submitted, and a change made to the permit. Refer to the city's Building Code, and amendments for additional information.

B. **Temporary Certificate of Occupancy (TC of O)**

The issuance of a [TC of O](#) allows temporary occupancy until the building is completed and a Final C of O is issued. Should the TC of O expire prior to the issuance of the Final C of O, the expiration will require the city to take appropriate steps as outlined in the [city's Building Code and the associated amendments](#). For each TC of O issued, a refundable cash deposit, or an irrevocable letter of credit acceptable to the Building Official, paid to the city, is required to assure compliance to code and ordinance requirements. The amount of the cash deposit will be the same as the cost of a combination building, electrical, mechanical and plumbing permit fee, as specified in Scottsdale Revised Code, Chapter 46, Article VII, or one thousand dollars (\$1,000.00), whichever is greater. Within 30 days of the issuance of the final C of O, the deposit will be refunded less a \$200.00 processing fee.

BUILDING ADVISORY BOARD OF APPEALS

1-2.900

The purpose of the [Building Advisory Board of Appeals](#) (BABA) is to:

Hear and decide appeals of orders, decisions, or determinations by the building official concerning the application and interpretation of the Building Codes, including claims that:

- A. The true intent of the Building Code (including its amendments) or the rule(s) adopted have been incorrectly interpreted;
- B. The Building Code (including its amendments) or the rule(s) do not fully apply to a specific project;
- C. A proposed form of construction, including alternative materials, is equally as good or better than the requirements of the Building Code (including its amendments).
- D. Make recommendations to the City Council regarding the adoption or modification to the Building Code.

BABA may, when it determines the Building Official has erred, modify or reverse an interpretation of the Building Official.

BABA typically reviews an application during the construction document plan review permitting phase of development.

A. **Variances, alternative materials and methods of construction.**

1. When an applicant is requesting the approval of a variance, alternative material, or method of construction from BABA, the Building Official may

require a pre-application submittal and meeting before the submittal of an application.

2. The Building Official or designee will provide the submittal requirements for a variance, alternative materials and methods of construction.

B. Appeal of the Building Official's Decision

An application for an appeal Building Official's decision shall be filled on city forms and include any related information within twenty (20) days after the written decision of the Building Official.

Request for a variances, alternative materials and methods of construction, or an appeal of the Building Official's decision to be reviewed by the BABA shall be submitted at Planning and Development Services Division's One Stop Shop to the attention of the Building Official:

Planning and Development Services Division

One Stop Shop

7447 East Indian School Road, Suite 105

Scottsdale, Arizona 85251

Phone: (480) 312 -7000

For additional information regarding the variances, alternative materials and methods of construction, and appeals process, applicants may also contact the Planning and Development Services Division at 480-312-7000, email planninginfo@ScottsdaleAZ.gov.

PUBLIC NOTIFICATION REQUIREMENTS

PROCESS	PLANNING COMMISSION AND CITY COUNCIL					DEVELOPMENT REVIEW BOARD	BOARD OF ADJUSTMENT	RESPONSIBLE PARTY
	General Plan Amendment (Major & Non-Major) Character Area Plan Amendment	Zoning Change Amendment (includes site plan and stipulation changes)	Zoning Text Amendment	CUP (includes municipal use master site plan)	Abandonment	Site Plan, Preliminary Plat, Building Elevation, etc.	Variance	
PRE-APPLICATION								
City Web Site	Yes	Yes	Yes	Yes	Yes	Yes	Yes	City
Citizen Review Plan	T	Required	Required	No	No	No	No	Applicant
GP and CA Neighborhood Involvement Plan	No	No	No	Required	T	Required	Required	Applicant
Neighborhood Notification Plan	No	No	No	Required T	Required	Required	Required	Applicant
Project Under Consideration Sign	T	4'x4'	T	T	No	T	No	Applicant
Project Information Letter/Postcard Radius of Notification Area	750' ***	750' ***	***	750' ***	T	750' ***	750' ***	Applicant
Open House Meeting Notify Project Coordinator in Advance	Required	Required	Required	T	T	T	T	Applicant
Citizen/Neighborhood Report	Required	Required	Required	Required	T	Required	T	Applicant
FORMAL APPLICATION								
Keeping Your Informed Postcard Radius of Notification Area (10-14 days after submittal)	750' **	750' **	*	750' **	750'	750'	750' ()	City

PUBLIC NOTIFICATION REQUIREMENTS

Notice of Public Hearing Sign	4'x4' Applicant	4'x4' Applicant	No	4'X4' Applicant	3 Signs 2'x3' City	2'x3' City	2'x3' City	Applicant/City
Newspaper Ad for Public Hearing	Yes	Yes	Yes	Yes	Yes	No	Yes	City
City's Web Public Hearing Info	Yes	Yes	Yes	Yes	Yes	Yes	Yes	City
Posting of Agendas (on-line & at 3 public places)	Yes	Yes	Yes	Yes	Yes	Yes	Yes	City
Planning Commission Hearing Info Postcard (15 days prior)	750'	750'	*	750'	750'	N/A	N/A	City
City Council Hearing Info Postcard (15 days prior)	750'	750'	*	750'	750'	N/A	N/A	City
Other Legal Requirements (certain projects)	See Statutory Requirements	See Statutory Requirements	See Statutory Requirements	T	T	T	T	Applicant/City

* Text Amendment notification list, plus any stakeholders, and 1/8-page ad in local newspaper of general circulation in the city.

** Plus, additional notification list that includes utilities, schools, and interested parties within the city, county and abutting cities and towns.

*** Plus, stakeholders or associated interested parties as determined by Coordinator.

() Hearing post card.

T May be required, consult Coordinator.

Section 1-3

CIVIL CONSTRUCTION DOCUMENT REQUIREMENTS

1-3

This section identifies requirements for preparing construction documents for civil plans that are submitted to city for approval. It includes cover sheet and plan sheet information, specifics for digital submittals, various approval blocks and special requirements.

SUBMITTAL REQUIREMENTS

1-3.000

Prepare all civil plans for submittal to city approval to construct grading and drainage, landscape, water, wastewater, and streets according to the following standards.

A. Sheet Size

Prepare plans on 24-inch x 36-inch sheets, unless otherwise approved by Chief Development Officer, prior to the first submittal of construction documents.

B. Scale

Requirements for scale depend on the type of submittal. See Chapter 4 for grading and drainage plan requirements. Plan and profile sheets shall use a horizontal scale of 1 inch = 20 feet and a vertical scale of 1 inch = 2 feet, unless otherwise approved by Chief Development Officer prior to the first submittal of construction documents.

C. Lettering

All lettering, numbering and line work must be uniform and legible. Use a minimum 10-point font for all lettering.

D. Plan Review Submittals

1. The number and types of plans sets to be submitted for review are identified in the construction document requirement checklist provided after the approval of a Development Review application.
2. Present plan layout, graphics and call-outs in a clear and an uncluttered manner acceptable to engineering and planning staffs.
3. Provide cross-referencing between all plan sheets that have details, detail call-outs, notes, cross-sections, etc.
4. Orient north at the top or right side of each sheet. Provide a north arrow and bar scale.

E. Seal/Signature

Include appropriate professional State of Arizona seal, signature and date on each sheet. Copies of this information are acceptable on the improvement plans submitted during the review cycles to the One Stop Shop. When original plans are submitted for approval at the end of plan review, the originals shall bear the registrant's seal with a wet signature and date. Except for capital improvement plans, a registered landscape architect is not required to prepare and seal landscape and irrigation plans.

F. Plan Approval Submittal

Upon approval of the civil plans, an additional plans set may be required for staff signature.

DIGITAL SUBMITTAL & REVIEW

1-3.100

Digital Submittal

The city allows Digital Plan Review for a several plan types.

- A. PDF is the standard electronic file format for submittal and reviewing plans and supporting documentation.**

- B. File and layer naming conventions need to follow the requirements specified on the city’s website.
- C. Digital Signature Acceptance per the [Board of Technical Registration](#), RA-30-304. G. Use of Seals: An electronic signature, as an option to a permanently legible signature, in accordance with Arizona Revised Statutes (A.R.S.) Title 41 and Title 44, is acceptable for all professional documents. The registrant will provide adequate security regarding the use of the seal and signature.

COVER SHEET

1-3.200

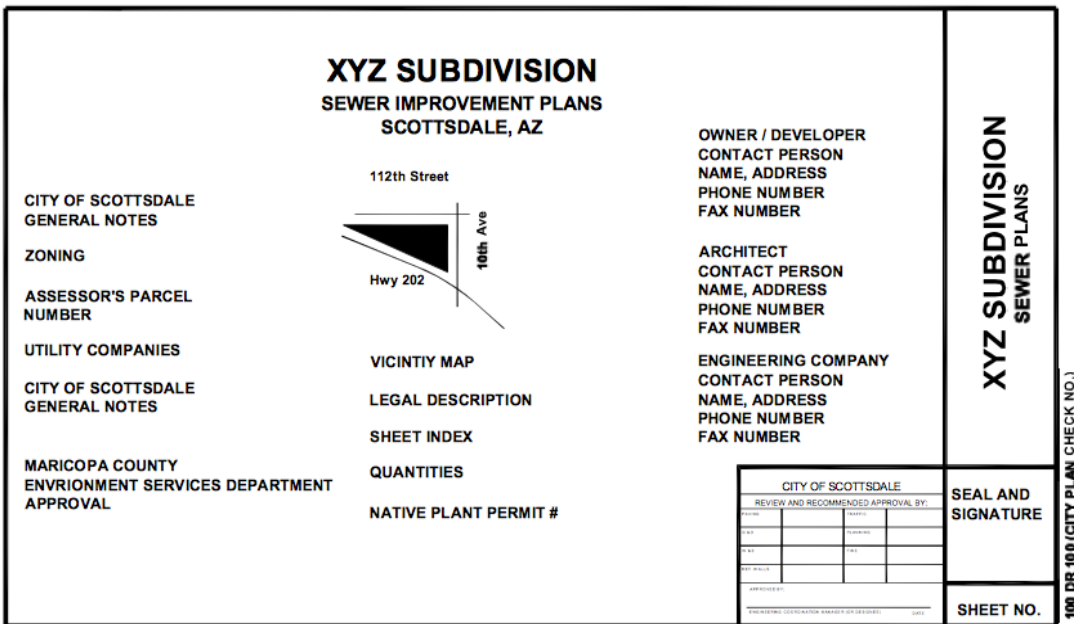

FIGURE 1-3.1 TYPICAL COVER SHEET

The following information depicted in Figure 1-3.1 must be included on the cover sheet.

- A. Title - Include the project name and the plan set content.
- B. City Name - Below the title, include the city name "Scottsdale, AZ".
- C. Vicinity Map - Locate the project relative to a minimum of 2 intersecting arterial streets.
- D. Legal Description - Provide project property legal description. When a legal description is not feasible, list the township, range, section and location.
- E. Benchmark.
 - 1. Elevation values shown on submittals are to be based on North America Vertical Datum 1988 (NAVD 1988) and meet the Federal Emergency Management Agency (FEMA) Benchmark Maintenance (BMM) criteria. See the criteria defined within the [Coordinator’s Manual of the National Flood Insurance Program Community Rating System](#). Use the [MCDOT benchmark system](#) in accordance with the BMM criteria.

2. All civil plans must contain a Benchmark on the cover sheet. Describe the location and character of monument and state the elevation of the benchmark.
3. All civil plans must also contain a statement certifying the datum used for all elevations represented in the plans to be included on the plan cover sheet immediately below the benchmark and shall state the following as seen in Figure 1-2.2.

I hereby certify that all elevations represented on this plan are based on NAVD 1988 and meet the FEMA Benchmark Maintenance (BMM) criteria.

FIGURE 1-3.2 BENCHMARK CERTIFICATION STATEMENTS

4. In addition, all plans that include an occupiable structure, residential or non-residential, are required to provide the Lowest Finish Floor elevation on the plans, including the Engineer’s Certification. The format for the Lowest Floor elevation shall be L.F. 88 = XXXX.YY feet.
The completed elevation is stated (for example 2695.67, NOT 95.67 or 695.67), and shall be the basis on the NAVD 1988 elevation datum, not an equated datum for the site.
- F. Civil Plan Signature Blocks - Include Civil Approval Blocks shown below, as applicable.
1. When civil plans do not include architectural, such as electrical, mechanical, plumbing, or structural elements for a gated entry to be constructed per the civil plan, use the Civil Approval and Reapproval blocks shown in Figure 1-3.3 and Figure 1-3.4

CIVIL APPROVAL			
Review & Recommended Approval by:			
Paving		Traffic	
G & D		Planning	
W & S		Fire	
Ret. Walls			
_____		_____	
Engineering Coordination Mgr.		Date	

FIGURE 1-3.3 CIVIL APPROVAL BLOCK

CIVIL RE-APPROVAL			
Reapproval No			
Revised sheet No.(s)			
Description of Revision			
Review & Recommended Approval by:			
Paving		Traffic	
G & D		Planning	
W & S		Fire	
Ret. Walls			
_____		_____	
Engineering Coordination Mgr.		Date	

FIGURE 1-3.4 CIVIL REAPPROVAL BLOCK

2. If civil plans depict construction or installation of architectural plans, such as electrical, mechanical, plumbing, or structural elements for a gated entry to be constructed per the civil plan, use the Civil and Architectural Approval and Reapproval blocks in Figure 1-3.5 and Figure 1-3.6.

CIVIL & ARCHITECTURAL APPROVAL					
Review & Recommended Approval by:					
Electrical		Paving		Traffic	
Mechanical		G & D		Planning	
Plumbing		W & S		Fire	
Structural		Ret. Walls			
<hr/>					
Engineering Coordination Mgr.				Date	

FIGURE 1-3.5 CIVIL AND ARCHITECTURAL APPROVAL BLOCK

CIVIL & ARCHITECTURAL RE-APPROVAL					
Reapproval No					
Revised sheet No.(s)					
Description of Revision					
<hr/>					
Review & Recommended Approval by:					
Electrical		Paving		Traffic	
Mechanical		G & D		Planning	
Plumbing		W & S		Fire	
Structural		Ret. Walls			
<hr/>					
Engineering Coordination Mgr.				Date	

FIGURE 1-3.6 CIVIL REAPPROVAL AND ARCHITECTURAL APPROVAL

- G. Landscape Plan Signature Blocks - Include the Landscape Maintenance Block shown in Figure 1-3.7:

ALL LANDSCAPE AREAS AND MATERIALS, INCLUDING THOSE LOCATED IN PUBLIC RIGHTS-OF-WAY, SHALL BE MAINTAINED IN A HEALTHY, NEAT, CLEAN AND WEED- FREE CONDITION. AMERICAN NATIONAL STANDARDS INSTITUTE (ANSI) A300 STANDARD PRACTICES FOR PRUNING, SUPPORT SYSTEMS, AND SAFETY SHALL BE USED FOR MAINTENANCE CRITERIA. THIS SHALL BE THE RESPONSIBILITY OF THE (Insert: *PROPERTY OWNER*. or *PROPERTY OWNER'S ASSOCIATION*. at the end of the sentence.)

FIGURE 1-3.7 LANDSCAPE MAINTENANCE BLOCK

If landscape and irrigation plans are not prepared by the same engineer/designer as the civil engineering drawings, include the Landscape Approval Blocks shown in Figures 1-3.8 and 1-3.9 on the cover sheet of the landscape and irrigation plans.

LANDSCAPE PLAN APPROVAL		
Case #	Approved by	Date
CONSTRUCTION AND INSTALLATION SHALL BE IN ACCORDANCE WITH THIS PLAN AND ALL DEVIATIONS WILL REQUIRE REAPPROVAL. THE CITY WILL NOT ISSUE A C OF O UNTIL INSPECTION SERVICES STAFF APPROVES THE LANDSCAPE INSTALLATION.		

FIGURE 1-3.8 LANDSCAPE APPROVAL BLOCK

LANDSCAPE PLAN RE-APPROVAL		
Reapproval No		
Revised sheet No.(s)		
Description of Revision		
Case #	Approved by	Date
CONSTRUCTION AND INSTALLATION SHALL BE IN ACCORDANCE WITH THIS PLAN AND ALL DEVIATIONS WILL REQUIRE REAPPROVAL. THE CITY WILL NOT ISSUE A C OF O UNTIL INSPECTION SERVICES STAFF APPROVES THE LANDSCAPE INSTALLATION.		

FIGURE 1-3.9 LANDSCAPE PLAN REAPPROVAL BLOCK

- H. No Conflict Signature Block/Coordinating with Utilities.
1. The developer must coordinate with all utility companies that will provide service to the site by sending them a copy of the proposed improvement plans and a No Conflict Form for signature. Please refer to the city’s website for the No Conflict Form. Include the No Conflict Signature Block shown in Figure 1-3.10 on the cover sheet of the improvement plans based on the information in the completed No Conflict Forms and submit with the first improvement plans submittal.
 2. Submit a completed No Conflict Form for each affected utility company with the improvement plans submittal to the One Stop Shop. Civil Plan approval and permits will be issued only after receiving all completed No Conflict Forms.

NO CONFLICT SIGNATURE BLOCK				
Utility	Utility Company	Name of Company Representative	Telephone Number	Date Signed
Electric				
Telephone				
Natural Gas				
Cable TV				
Other				
Other				
<p>Engineer's Certification</p> <p>I _____, as the Engineer of Record for this development, hereby certify that all utility companies listed above have been provided final improvement plans for review, and that all conflicts identified by the utilities have been resolved. In addition, "No Conflict" forms have been obtained from each utility company and are included in this submittal.</p> <p style="text-align: center;">Signature Date</p>				

1-3.10 NO CONFLICT SIGNATURE BLOCK

- I. FEMA Blocks and Information.
 - 1. In accordance with the Federal Emergency Management Agency and city requirements the following information in Figure 1-3.11 must be included on the cover sheet of all plans in order to establish lowest finish floor elevations and flood proofing elevations for both residential and nonresidential structures.

Community Number	Panel # Panel Date	Suffix	Date of FIRM (Index Date)	FIRM Zone	Base Flood Elevation (in AO Zone use Depth)
045012					

FIGURE 1-3.11 FLOOD INSURANCE RATE MAP (FIRM) INFORMATION

- 2. Include the Engineers FEMA Certification shown in Figure 1-3.12.
- 3. Please Note: Certification of data is a statement that the data is accurate to the best of the Certifier's knowledge. Certification of analysis is a statement that the analyses have been performed correctly and in accordance with sound engineering practices. Certification of structural works is a statement that works are designed in accordance with sound engineering practices to provide

protection from the base flood. Certification of as-built conditions is a statement that the structure has been built according to the plans being certified, is in place, and is fully functioning (from the Code of Federal Rules – 44 CFR 65.2).

The lowest floor elevation(s) and/or flood proofing elevation(s) on this plan are sufficiently high to provide protection from flooding caused by a 100-year storm, and are in accordance with Scottsdale Revised Code, Chapter 37 – Floodplain and Stormwater Regulation.

FIGURE 1-3.12 ENGINEERS FEMA CERTIFICATION

- J. Maricopa County Environmental Services Department (MCESD) Approval.
Prior to the city approving the civil plans, MCESD is required to review and approve all public water and wastewater line extensions and construction of all water and wastewater related facilities within the city's service area. The developer must include a signature block with a completed signature and date of approval from MCESD. Relocation or realignment of an existing water or wastewater line to resolve a utility conflict does not require county approval.
- K. As-Built Certification.
Provide a statement that the surveyor of record for the project certifies that "record drawing" measurements as shown were made under the surveyor's supervision or as noted and are correct to the best of the surveyor's knowledge and belief. Also, provide a signature line for the name of the registered land surveyor, the date and the registration number.
- L. City Project and Case Numbers.
List all applicable plan check numbers and case numbers in the border along right edge using a minimum of ¼ inch (24-point font) size lettering. Case numbers may include approvals for zoning (ZN), UP, development review (DR), preliminary plat (PP) and staff approvals (SA). List all applicable plan check numbers for the improvement plans, including other related plans, such as master plans, basis of design reports, stormwater storage waiver, etc.
- M. Public Works Construction - Include General Notes for Public Works Construction shown in Figure 1-3.13.
- N. Sheet Index.
- O. Utility system ownerships.
- P. Other agency approvals as required.
- Q. Contact Information - Provide engineer, architect, owner and developer company names, contacts, addresses and telephone and fax numbers.
- R. Construction quantities (for work in public rights-of-way or easements).
- S. Zoning - Identify current zoning of the property
- T. Legend - Define symbols, non-standard abbreviations, etc.
- U. "Blue Stake" Note - Required on all plans that include excavation of any type, see Figure 1-3.13.

- V. Key Map - Provide a key map on multi-sheet plans to relate plan sheets to project locations and type of improvements.
- W. Storage Basin Volumes - State the volume provided, and volume required for stormwater storage basin certification.
- X. Native Plant Plan and Permit number.
- Y. General notes for public works construction:

GENERAL NOTES FOR PUBLIC WORKS CONSTRUCTION
1. All construction in the public rights-of-way or in easements granted for public use must conform to the latest MAG Uniform Standard Specifications and Uniform Standard Details for Public Works Construction as amended by the latest version of the City of Scottsdale Supplemental Standard Specifications and Supplemental Standard Details. If there is a conflict, the city's Supplemental Standard Details will govern.
2. The city only approves the scope, not the detail, of engineering designs; therefore, if construction quantities are shown on these plans, they are not verified by the city.
3. The approval of plans is valid for six (6) months. If a right-of-way permit for the construction has not been issued within six months, the plans must be resubmitted to the city for reapproval.
4. A Public Works inspector will inspect all works within the city rights-of-way and in easements. Notify Inspection Services 24 hours prior to beginning construction by calling 480-312-5750.
5. Whenever excavation is necessary, call the Blue Stake Center, 811, two working days before excavation begins. The Center will see that the location of the underground utility lines is identified for the project.
6. Right-of-way permits are required for all work in public rights-of-way and easements granted for public purposes. A right-of-way permit will be issued by the city only after the registrant has paid a base fee plus a fee for inspection services. Copies of all permits must be retained on-site and be available for inspection at all times. Failure to produce the required permits will result in immediate suspension of all work until the proper permit documentation is obtained.
7. All excavation and grading that is not in the public rights-of-way or not in easements granted for public use must conform to Appendix J, Grading, of the latest edition of the International Building Code. A permit for this grading must be secured from the city for a fee established by the city.

FIGURE 1-3.13 GENERAL NOTES FOR PUBLIC WORKS CONSTRUCTION

AS-BUILTS

1-3.300

The registrant will provide the city with the original (4-mil) Mylar drawings or photographic (4-mil) Mylars required for the As-Builts of construction within all public rights-of-way or easements dedicated to the city.

REPORTS & OTHER DOCUMENTS

1-3.400

Reports and other submitted documents must include the following:

- A. Appropriate State of Arizona professional seal, signature and date;
- B. 8 ½ inches x 11 inches format for exhibits. Larger size exhibits may be included, provided they are secured within the report or document. Any exhibits that are not bound in the document shall bear the appropriate State of Arizona professional seal, signature and date.

DIRT HAUL/ENCROACHMENT PERMIT

1-3.500

- A. Obtain a Haul Route/Encroachment Permit when estimated dirt hauls (dirt, demolition debris, etc.) of 5,000 cubic yards or more require use of the public rights-of-way.
- B. Estimated dirt hauls of less than 5,000 cubic yards may require a "Haul Route / Encroachment Permit" as determined by the city at the time of grading plan review.
- C. The Haul Route / Encroachment Permit must address:
 1. Haul Routes (see Figure 1-3.14 as an example)
 2. Travel times
 3. Traffic control requirements (such as barricade plans and signage)
 4. Dust control requirements
 5. Restoration procedures
 6. Safety procedures
 7. Public notification
 8. Possible additional requirements

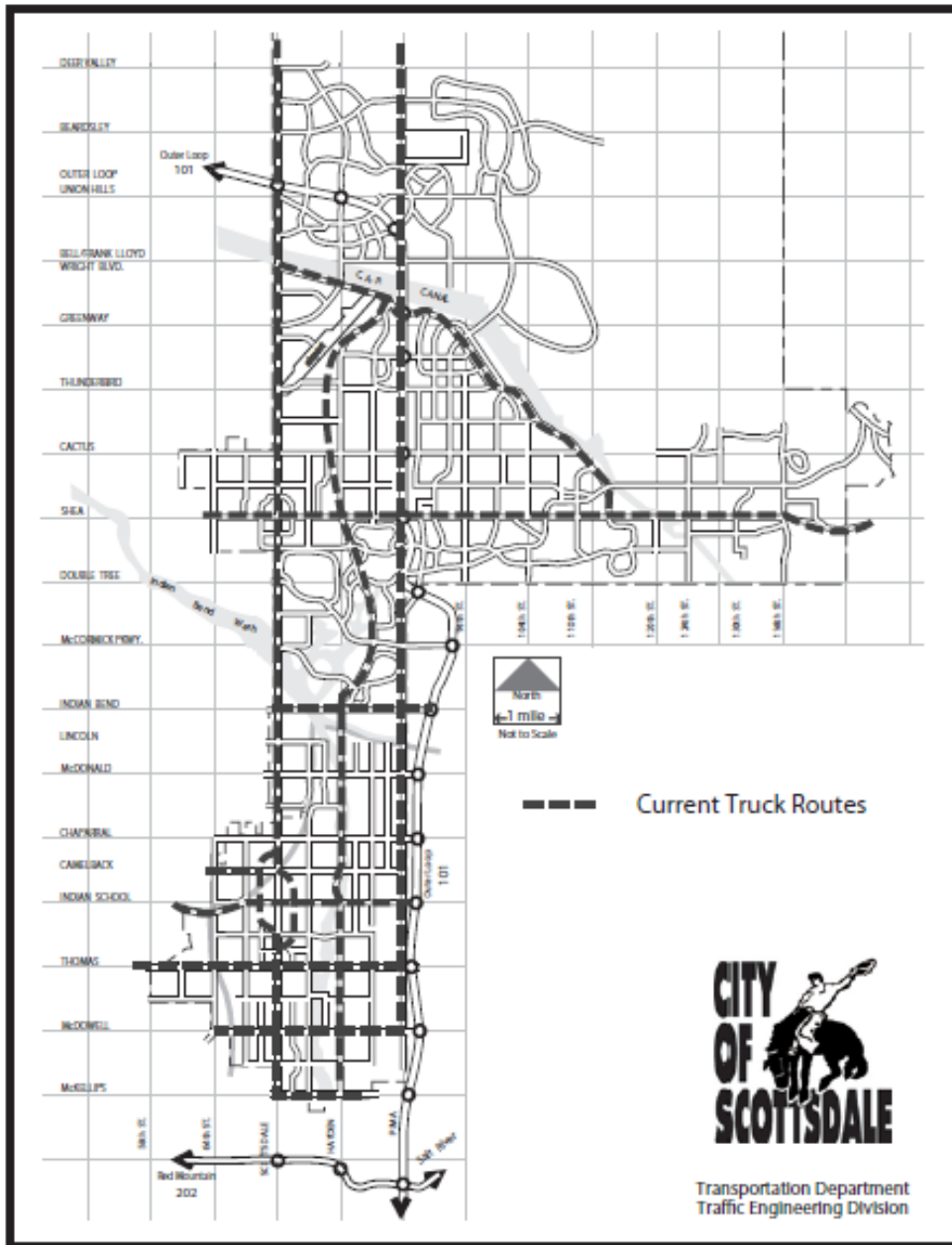

FIGURE 1-3.14 DIRT HAUL ROUTES

SOIL NAIL SHORING PERMIT REQUIREMENTS

1-3.600

- A. To install soil nails within public or private right's-of-way and easements a right-of-way permit will need to be issued through the plan review and permitting process.
- B. Only non-steel soil nails shall be allowed.
- C. Soil nails shall be a minimum of eight (8) feet below finished grade. Soil nails shall have a minimum of six (6) feet separation on all sides of any utility.
- D. Written authorization from adjacent property owner shall be required for soil nails extending onto adjacent private property

- E. The owner/developer is required to video the existing storm drain (SD) before and after the soil nail installation to confirm no contact or damage has been done to the SD pipe. The Civil Engineer of record will review the tapes and provide a sealed letter that states no damage has been done to the existing SD during construction. The before and after video and sealed letter shall be submitted to the civil inspector.
- F. Plan sheet requirements shall be as follows:
1. Provide the civil engineer's Arizona seal and original signature on each sheet.
 2. Provide a no utility conflict approval block executed by utility companies.
 3. Pot-holed and survey depth and location of all existing utilities and drainage facilities within and adjacent to the property boundaries shall be shown.
 4. Provide the location, angle, and depth of the first row of soil nails.

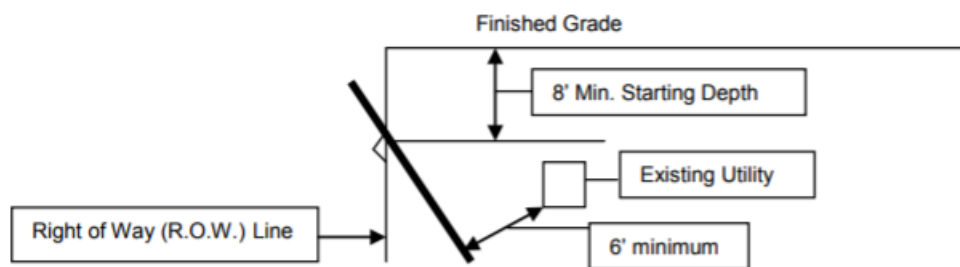

FIGURE 1-3.15

5. Show the area being affected by the soil nails delineated.
 6. Provide distance and bearing from a section corner to the property corner.
 7. Provide shoring method details indicating length, angle, material, etc.
 8. Provide the elevation of each soil nail head using NAVD 1988 and meeting the FEMA Benchmark Maintenance (BMM) criteria.
 9. Show all existing and proposed easements, dedications, right-of-way, streets, and alleys with dimensions and offset. Streets shall be identified by name. Streets, alleys, and easements shall be dimensioned at least once and at all breaks. Monument line of streets shall be shown.
 10. All proposed and existing structures, paving and other topographic features affected by construction shall be shown.
- G. All soil nails within public or private rights-of way and easements are required to be as-built for location and penetration using NAVD 1988 and meeting the FEMA Benchmark Maintenance (BMM) criteria. As-builts are to be submitted to the city's civil inspector.

Chapter 2

SITE PLANNING

2

This chapter describes design standards and procedures to guide the creation of a site plan, preliminary plat (PP), development plans, development master plan, and other similar types of plans. Also, this chapter references site and streetscape guidelines that are to be utilized to achieve the preferred character for development in specific areas of the city. In addition, this chapter provides specific guidance for preparing site plans and related designs within areas designated by the Environmentally Sensitive Lands (ESL) Ordinance.

2-1 GENERAL CONSIDERATION & REQUIREMENTS

2-2 ENVIRONMENTALLY SENSITIVE LANDS

2-3 DEVELOPMENT PLANS & MASTER DEVELOPMENT PLANS

Section 2-1

GENERAL CONSIDERATIONS & REQUIREMENTS

2-1

This section provides general guidance for most projects and conditions in the city, including design guidelines for specific areas and uses, site context considerations, on-site circulation and parking, emergency access and fire lane dimensions, drainage facilities, landscape, subdivision and neighborhood design, refuse collection, and outdoor lighting. Furthermore, this section describes master design concepts plans and development plans. These guidelines supplement ordinance provisions and provide basic approaches and preferred standards.

SCOTTSDALE SENSITIVE DESIGN PROGRAM + PRINCIPLES

2-1.000

The [Scottsdale Sensitive Design Program](#) is a comprehensive compilation of policies and guidelines related to the city's built environment. The basic framework for these policies and guidelines are the Sensitive Design principles. Derived from the General Plan, existing policies and concepts developed by citizen groups, the Planning Commission, Development Review Board (DRB), and City Council, the Scottsdale Sensitive Design Program and Principles are the basis of all the city's design guidelines that outline Scottsdale's design and development vision, expectations, and values.

DESIGN GUIDELINES FOR SPECIFIC USES

2-1.100

Scottsdale has developed architectural and site planning guidelines for specific types of land uses within the City. These contain details and standards that apply to the specific use that are in addition to the other standards contained in the General Plan, Zoning Ordinance, Character Area Plans, and this manual. The most commonly utilized and referenced guidelines are:

A. Design Guidelines for Office Development:

This set of guidelines includes site planning and design, architecture, landscape design, lighting, and identification/signage, as they relate to office industrial, office warehouse, office aircraft hangar, and general office projects. They address the context of a site, responding to the natural setting and climate of the desert southwest, and achieving quality design.

B. Design Guidelines for Gas Station and Convenience Store Development:

This set of guidelines includes site design, architecture, fuel pump islands, landscape, lighting, and signage/corporate identification. Special focus is made on canopies over the fuel pump islands and lighting solutions for such high activity areas.

C. Downtown Urban Design + Architectural Guidelines:

This set of guidelines serve as a decision-making tool to help provide clarity to what is valued and expected in downtown design. In conjunction with the Downtown Character Area Plan, the Scottsdale Zoning Ordinance, and the Design Standards and Policy Manual, the guidelines will direct design in a way that considers the larger context, complements the established character, and enhances the overall identity of downtown. The guidelines address site design, architectural design, landscape, lighting, signage, enhancement of the pedestrian environment, and open space.

D. Design Guidelines for Commercial Development:

This set of guidelines includes site design, architecture, landscaping, lighting, and signage/corporate identification. Emphasis is placed on relating to the local context, parking areas, pedestrian access, and design appropriate to the setting and climate of the desert Southwest.

E. Restaurant Design Guidelines:

This set of guidelines is applicable to all restaurant types. The guidelines are intended to promote good design that is responsive to its contextual setting. The guidelines outline the city’s expectations with regard to restaurant design and are intended to assist applicants, decision-makers, and staff in the consistent development, review, and consideration of restaurant proposals.

F. Scenic Corridor Design Guidelines:

This set of guidelines includes policies, standards, details, and concepts to create and maintain the basis for visual character within and along roadways designate by the General Plan as having an emphasis on retaining and displaying the native desert and traditional southwest cultural heritage of the area.

G. Additional Design Guidelines:

In addition to the above referenced design guidelines, the City of Scottsdale (city) has other common guidelines and policy available on the city’s website (www.ScottsdaleAZ.gov) that include, but are not limited to:

1. Designing for the Desert: Shading
2. Exterior and Site Lighting Design Guidelines
3. ATM Lighting Design Guidelines
4. Scottsdale ‘Desert’ Parks Design Guidelines
5. Scottsdale Golf Courses Policy
6. Scottsdale Road Streetscape Design Guideline
7. Shea Blvd Streetscape Guidelines
8. Frank Lloyd Wright Streetscape Design Guidelines
9. McDowell Road Streetscape Guidelines
10. Via Linda Streetscape Guidelines

ADDITIONAL DESIGN GUIDELINES

2-1.200

Scottsdale has developed specific design standards for all development that is subject to the DRB process. Unless specifically modified by the DRB or City Council through stipulation(s), all development shall incorporate the following:

SITE CONTEXT

2-1.201

The following guidelines focus on the relationship of a proposed site plan to the natural terrain of the property, as well as the relationships this proposal will have with existing or planned uses adjacent to it. The goals are to fit development into the natural site with minimal intrusion, and to be sensitive to adjacent uses.

TERRAIN

2-1.202

- A. Incorporate the natural site features, such as washes or native desert vegetation, into a site design.
- B. Incorporate desert washes as site amenities. Orient common recreational, patio, outdoor dining, and other such facilities toward such natural features.
- C. Incorporate major vistas and view corridors that give special emphasis to mountains, natural features, or open space areas in to the site and building design.

- D. Keep major desert vegetation specimens in place wherever they are located, particularly if they are located in required setbacks, parking area, landscape islands, or other such open space areas.
- E. On sites where there is significant change in the grade levels from the site to adjacent properties, utilize gradual site design techniques such as landscaped terraces, landscaped slopes of 4:1 (run-to-rise) or gentler, or some similar gradual techniques, to accommodate the grading transition.
- F. Retaining walls of over 2 feet in height shall not be placed at the property line.

BUFFERING FOR ADJACENT LAND USES

2-1.203

- A. Site plans for non-residential uses that are next to residential uses, or for multi-family uses next to single-family uses, should incorporate the following buffering techniques:
 1. Locate refuse containers either internally to the site or at least oriented toward the interior of the site;
 2. Locate loading areas either away from the perimeter of the site or screened from the perimeter by a solid wall tall enough to shield the unloading operations and vehicles from off-site views;
 3. Use landscaped open spaces to screen on-site buildings and activities;
 4. Locate outdoor dining areas and patios where the on-site buildings will screen them from views from the adjacent properties or where they are sufficiently screened by walls, landscape improvements, and significant distance, so that they have no discernible impact on adjacent properties; and
 5. When the site has a non-residential use and the adjacent site is a residential use, incorporate screening walls along the edge of the parking/driveway areas if the developing site is higher than the adjacent site or at the property line if the site is lower.
Install landscape improvements that are substantial enough in size and density to achieve the desired buffering effect as soon as possible. These landscape improvements should:
 6. Utilize two (2) inch minimum caliper or larger tree materials;
 7. Utilize the mature size of the tree canopy to determine the spacing between trees if the landscaped areas are less than 10 feet wide, or provide one (1) tree for every 300 to 400 square feet for larger landscaped areas;
 8. Utilize earth berms or mounding in combination with landscape plant material in area within forty (40) feet of the perimeter of the development project; and
 9. If trees are illuminated, utilize pendant light fixtures.

AIRPORT & AIRPARK DEVELOPMENT

2-1.204

- A. The owner of developments within the Airport Influence Area must comply with federal aviation requirements and the Scottsdale Revised Code (SRC), Chapter 5 – Aviation, Airpark Minimum Operating Standards and the Airpark Rules and Regulations.
- B. Developments within a 20,000-foot radius surrounding the Scottsdale Airport property require submittal of an [Airport Vicinity Development Short Form](#) that may

require evaluation for aircraft overflight (avigation easement) and noise disclosure requirements, FAA height analysis, and review of compatible use.

- C. Developments with taxi-lane access and /or parcels adjacent to airport property require a [Scottsdale Airport Vicinity Development Long Form](#) and additional items as listed on the checklist. The appropriate checklist will be provided during the development review pre-application process, or during project review, the completed form(s) should be submitted prior to final plan submittal to the assigned city project manager.

SITE DESIGN STANDARDS

2-1.205

- A. Construct perimeter and site walls with 6 or 8-inch-wide concrete masonry blocks, 8 inches wide brick, stone, concrete, or a similar solid and durable material to match the building. Stucco and paint the surface of concrete block walls to match the onsite buildings unless they are split-faced, grid or similar decorative types of block. Locate grade breaks at the top of the wall at piers or corners wherever possible. Include varied setbacks, alignments, and/or heights and/or piers or buttresses for walls over 200 feet long the horizontal and vertical alignment of the wall for visual interest.
- B. Use vinyl coated chain link fencing for recreational courts (i.e. tennis, basketball, volleyball, etc.). Use black, dark brown, or dark green vinyl coated chain link fencing on property with the Environmentally Sensitive Land overlay zoning.
- C. 'Dooley' concrete block wall/fence materials shall not be allowed.
- D. Place barbed, razor and/or concertina wire in locations where it is not visible from a street, alley or an adjacent property.
- E. Use tapered, conical, and one-piece flag poles. Acid wash exposed aluminum and/or galvanized poles prior to installation to provide a patina finish.
- F. Treat exposed large rock and boulder faces that are scarred during construction with desert varnish to the satisfaction of the Planning and Development Services Department's General Manager.
- G. Use patio umbrellas that have solid colors and do not have any advertising in the form of signage or logos.
- H. All exterior mechanical, utility, and communications equipment shall be screened by the parapet or wall that matches the architectural characteristics, color, and finish of the building. Wall or parapet heights used to screen roof-mounted units shall be equal to or exceed the height of the tallest unit. Wall heights for ground-mounted units shall be a minimum of 1-foot higher than the tallest unit.

UTILITY CABINETS, TRANSFORMERS AND PEDESTALS

2-1.206

Do not locate utility cabinets, transformers, or pedestals within sight distance or traffic safety triangles associated with driveways and road intersections, or within a public access easement, path easement and/or a trail easement, or in a sidewalk. Place utility cabinets, transformers, and pedestals along side streets instead of along the streets that are designated to have scenic corridors, desert scenic buffers, or open space corridors. Locate utility cabinets so that the cabinet doors (when open) do not obstruct a public access easement, path easement and/or a trail easement, or a sidewalk.

Whenever possible, screen utility cabinets with architectural metal fencing or walls that match nearby perimeter or screen walls, berming, and/or dense landscaping. Locate utility cabinets for a development on site and behind the building so they are not visible from the public right-of-way, public access easement, roadway easement, or private street.

SERVICE ENTRANCE SECTIONS

2-1.207

Incorporate Service Entrance Sections (SES) into the design of the building, either in a separate utility room, or with the face of the SES flush with the building face. Unless approved by the DRB, locate the SES on the side of a building that is not adjacent to a public right-of-way, roadway easement, or private streets.

CITYWIDE EXTERIOR LIGHTING DESIGN GUIDELINES

2-1.208

Scottsdale has developed specific lighting design standards for all development that is subject to the Development Review process. Unless specifically modified by the DRB or City Council through stipulation(s), all development shall incorporate the following:

A. General Lighting Design Standards

1. All exterior luminaires shall meet all IESNA requirements for full cutoff (IES B.U.G. of UH = 0, UL = 0, BVH less than 10 percent of the total luminaire lumens, and FVH less than 10 percent of the total luminaire lumens), and shall be aimed downward, except when allowed by the Zoning Ordinance and the DRB.
2. All luminaires shall be recessed or shielded so the light source is not directly visible from property line, except when allowed by the Zoning Ordinance and the DRB.
3. Wall mounted luminaires that are adjacent to residential zoning districts and/or Environmentally Sensitive Lands (ESL) zoning district areas of the city shall contain house-side shields and be mounted on a minimum 4-inch long bracket that is mounted perpendicular to the wall.
4. The total lumen per luminaire shall not exceed 24,000 lumens, except for sports court and sports field lights.
5. All luminaires that utilize high intensity discharge (HID) lamps in the geographic part of COS planned for the ESL zoning district (ESL area) shall be high pressure sodium lamps, except for sports courts. All other luminaires lamps or LEDs used for pedestrian areas, exterior area lighting, or when required by the DRB shall have a color temperature that does not exceed 2800 kelvin, except that sports court lamps or light sources are not to exceed 4100 kelvins (3000 kelvin is preferred). LED luminaires used for street and parking lot areas, or when required by the DRB, shall have a color temperature that does not exceed 2200 kelvin +/- 300 kelvin.
6. All exterior bollard luminaires shall meet all IESNA requirements for cutoff, unless full cutoff (IES B.U.G. of UH = 0, UL = 0, BVH less than 10 percent of the total luminaire lumens, and FVH less than 10 percent of the total luminaire lumens) is required by the Zoning Ordinance and shall have non-reflective exterior louvers. The louvers shall be positioned to screen the light source from view.

7. All bollard lamps shall utilize an incandescent, halogen incandescent, or compact fluorescent lamps that are coated/diffused lamps or LED source.
 8. The maximum height from finished grade to the bottom of the any exterior luminaire shall not exceed twenty (20) feet, except in the ESL areas of the city, parking lots adjacent to residential zoning districts, sports court, sports field lights, churches adjacent to residential zoning districts, and/or as specified by the Zoning Ordinance.
 9. In the ESL areas of the city, parking lots, churches, and/or as specified by the Zoning Ordinance, the maximum height from finished grade to the bottom of the any exterior luminaire shall not exceed sixteen (16) feet.
 10. In the ESL areas of the city, parking lots, site lighting, and building mounted exterior lighting should be reduced to security levels at 10 p.m., or 1 hour after the close of business, whichever occurs later. Exterior lighting shall be controlled by an astronomical clock and photocells.
 - a. Pre-curfew shall be dusk to 10 p.m., or 1 hour after the close of business, whichever occurs later.
 - b. Post-curfew shall be 10 p.m., or 1 hour after the close of business, whichever occurs later, to dawn.
 11. In the ESL areas of the City, no lighting shall be permitted in Natural Area Open Space (NAOS) easements, vista corridor easements, scenic corridors, buffered setbacks, and/or desert scenic roadways setbacks.
 12. All exterior light poles, pole fixtures, and yokes, including bollards, shall be a flat black or dark bronze.
 13. Subject to the approval of the DRB, the maintained average horizontal illumination at grade, within 10-feet of the primary customer storefront entries shall not exceed the maintained average horizontal illumination level at grade of five (5) foot-candles. The maintained maximum horizontal illumination level at grade along the storefront entries shall not exceed fifteen (15) foot-candles. The foot-candle reading shall include any spill light from the store's interior.
 14. Any lighting system for sports court or sports field facilities are required to obtain a separate approval from the DRB, or Staff Approval. The type of approval shall be as determined by the Zoning Administrator.
 15. Parking lot lighting poles and bases shall not be placed in the two (2) foot parking stall over hang or in a parking stall.
- B. Carport Lights shall comply with the Zoning Ordinance, and shall be recessed within the canopy, not extend below the fascia, and the light source shall not be directly visible from the property line. Fixtures shall include integral shields and horizontal lens.
- C. Gas Station, Convenience Store, and Automated Teller Machines Lighting
All exterior illumination for Gas Station, Convenience Store, and Automated Teller Machines (ATM) drive-thru and walk-up locations shall comply with the Zoning Ordinance and shall not exceed the illumination levels that are specified within the Gas Station and Convenience Store Development Design Guidelines and ATM Lighting Guidelines.

D. Landscape Lighting

All landscape lighting shall be included as part of the DRB application; if approved by the DRB, all landscape lighting shall comply with the following:

1. A landscape luminaire on a property with a Single-family Residential District zoning (R1-) shall be directed downward and incorporate a lighting shield in conformance with the Zoning Ordinance.
2. A landscape luminaire on a property with zoning other than R1-, shall incorporate a light shield, be directed in accordance with the Zoning Ordinance.
3. A landscaping luminaire shall only be utilized to accent plant material.
4. Any landscape luminaire that is directed upward shall utilize an extension lighting shield to limit the view of the illumination source, be aimed away from any adjacent property line, and were practical, located on the west or east sides of the object being illuminated.
5. Any landscape luminaire that is hangs in vegetation, shall contain a recessed illumination source, a light shield, and be directed downward and away from property line.
6. A landscape luminaire illumination source utilized on a property that does not have ESL zoning shall have a kelvin temperature of 3000 or less.
7. A landscape luminaire illumination source utilized on a property that does not have ESL zoning shall have total initial lumens of all light sources within a luminaire that does not exceed 1200 lumens.
8. A landscape luminaire utilized on a property zoned with the Environmental Sensitive Lands overlay district shall have total initial lumens of all light sources within a luminaire that does not exceed 800 lumens.

OUTDOOR LIGHTING AMBIENT LIGHTING ZONES

2-1.209

The Illuminating Engineering Society (IES) has developed a concept of Ambient Lighting Zones to provide appropriate lighting levels based on the context of an area. This recognizes that urban areas with a great deal of pedestrian activity need different lighting levels than areas of very large lots and passive expanses of open space. Refer to Figure 2-1.1 which represents where such ambient lighting zones are located within the City. The design of outdoor lighting should be based on these lighting zones, in conjunction with the most recent [Illuminating Engineering Society \(IES\) lighting design manuals](#).

E-1 Intrinsically Dark Areas:

These are predominantly passive open space areas or very low density residential neighborhoods, typically the desert preserves areas and it may include residential lots that are 3 acres or larger. There is little nighttime activity and few outdoor lighting sources.

E-2 Estate/Rural Areas:

These are low-density areas, typically ½ to 2-acre residential lots, or there are substantial areas of passive open space interlaced within the pattern of development. Pedestrian activity is minimal but there are occasional retail/service and community service facilities that have nominal amounts of local activity.

Lighting levels are generally low; there is often an expectation in the neighborhoods that the lighting levels remain low.

E-3 Suburban Areas:

These are the typical suburban areas that have moderate to higher residential densities along with a mix of campus or open style retail, service, employment, and public facilities. Lighting levels in general are moderate, although in some areas, such as those around retail centers or schools, the need for higher lighting levels may exist.

E-4 Urban/Pedestrian Activity Areas:

In these areas there are typically dense land uses, often with buildings located near the streets, and there is a rich mix of different uses. Retail and cultural uses tend to generate higher levels of pedestrian activity, resulting in the need for higher levels of lighting.

Use these general lighting design principles for outdoor lighting:

- A. Consider the characteristics of the adjacent land uses in all lighting designs. Maintain the existing ambient lighting level of adjacent residential areas.
- B. Focus outdoor lighting on identified tasks instead of providing a wash of lighting across a site or building. Emphasize lighting for pedestrian access and activity areas such as building entrances, walkways, and outdoor gathering facilities.
- C. Provide gradual transitions from well-lit to unlit areas.
- D. Special uses, such as sports facilities or outdoor displays, will require specific lighting approaches.
- E. In general, the lighting source should not be visible from off the property.

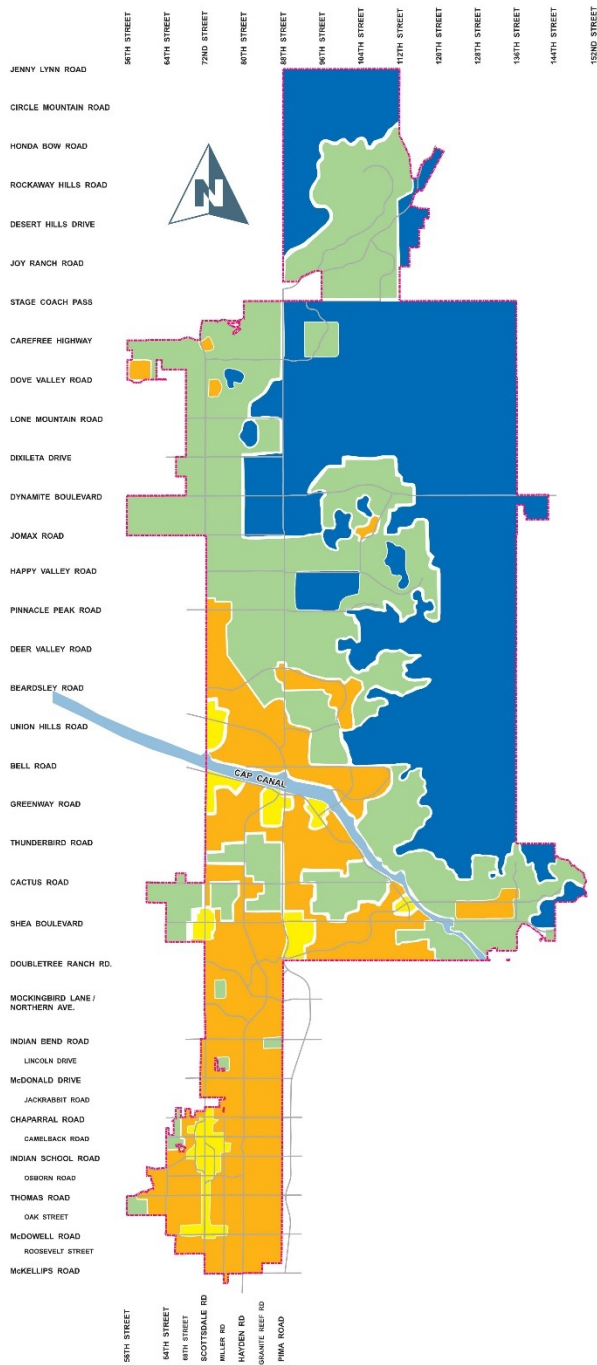

Ambient Lighting Zones

Legend

- E1 - Intrinsically Dark
- E2 - Estate/Rural
- E3 - Suburban
- E4 - Urban Pedestrian Activity
- CAP Canal
- Streets
- City Boundary

Ambient light of the contextual area may supercede map designation.

Digital map enabled by Josh Black
on March 22, 2017

FIGURE 2-1.1 AMBIENT LIGHTING ZONES

BUILDING DESIGN STANDARDS

2-1.210

- A. All exterior conduit and raceways shall be painted to match the building.
- B. No exterior roof ladders shall be allowed where they are visible to the public or from an offsite location.
- C. If overflow scuppers are provided, they shall be integrated with the architectural design. Rooftop drainage shall be designed and constructed to minimize erosion or staining of nearby building walls, and direct water away from the building foundations.

SUSTAINABLE SITE & BUILDING DESIGN

2-1.211

Energy efficient building designs that respond to site orientation and daily/seasonal solar patterns can significantly reduce energy demands and achieve net zero (positive) energy when coupled with on-site solar energy generation systems. Sustainable building sites account for heat island mitigation, water efficient landscaping, pedestrian connectivity, accommodations for alternative modes of transportation, low impact building materials, and recycling facilities.

A. Heat Island Mitigation

Not less than 50% of the site hardscape should be provided with one or any combination of the following methods:

- 1. Hardscape materials that have an initial solar reflectance value of not less than 0.30.
- 2. Shade structures, including louvers, perforated materials, and vegetated trellises
- 3. Vegetated ground cover or trees based on mature canopy size
- 4. Pervious and permeable unit pavements

B. Building Orientation, Entrances and Glazing

- 1. Primary building entrances on the east, south, and west sides of a building should be protected from direct sunlight between the hours of 10:00 AM and 5:00 PM from March 21 through September 21 by one or any combination of the following methods:
 - a. Architectural elements, including recessed entries, arcades, deep overhangs, baffles and perforated screen walls
 - b. Vegetation including vegetated screen walls
- 2. At least 50% of east, south and west facing glazing should be protected from direct sunlight between the hours of 10:00 AM and 5:00 PM from March 21 through September 21 by one or any combination of the following methods:
 - a. Architectural elements, including recessed windows, deep overhangs, vertical baffles and perforated screen walls
 - b. Trees and vegetated, screen walls

C. Landscape Irrigation System

- 1. A smart irrigation controller should be provided that regulates irrigation based on weather, climatological, or soil moisture conditions. The controller should have integrated or separate sensors to suspend irrigation events during rainfall.
- 2. Irrigation zones should be based on plant water needs with plants of similar needs grouped together.

D. Transportation Impact Mitigation

1. Electric vehicle ready accommodations are recommended as follows:
Installation of conduit and sufficient capacity in the electrical power distribution panels sized to supply at least two future charging stations based on a design load of not less than 40 amperes per parking space at a supply voltage of not less than 208/240 VAC.
2. Bicycle parking spaces should have an area of not less than 18 inches by 72 inches for each bicycle and provided with a rack or other facility for securing each bicycle.
3. Buildings, other than residential, should be provided with a changing room and shower facilities for employees who commute by bicycle.

E. Solar Energy Generation

1. On-site solar photovoltaic (PV) and solar thermal panels should be integrated into the architectural design of the building considering roof configuration, slopes, architectural appurtenances and panel placement uniformity. Otherwise, solar panels should be screened to not be visible from street level. This includes ground mounted systems.
2. Solar energy generation facilities are also encouraged for parking and site shade structures particularly when designed as an integrated component.

F. Waste Management and Recycling Facilities

When designing new developments and redevelopment of existing property, recycling of recyclable refuse is recommended to be accommodated in the site and building design. It is recommended that the sites and buildings are designed to accommodate:

1. Kitchen cabinets in multifamily dwelling units that allow pull out trash and recycling bins;
2. Separate refuse and recycling refuse chutes in multifamily buildings that are 4 or more stories in height; and.
3. Separate refuse and recycling containers refuse enclosures for storage and collection.

G. Building Materials

1. Incorporate recycled-content materials (e.g. – metals, steel), regional materials (e.g. - masonry, stone, earthen materials), bio-based materials from sustainably managed forests (e.g. - FSC, SFI or PEFC certified woods), and used materials from deconstructed buildings (e.g. - timbers, metals, steel).
2. Use low emitting VOC (volatile organic compounds) finishes for paints, sealants, adhesives and flooring.
3. Wood should not be used as an exterior material unless it is protected by overhangs or similar techniques that minimize exposure to the sun and rain.
4. Native stone is preferred in lieu of artificial, cast, or 'faux' stone. If artificial stone is used, it should be a type of stone that is found in the Southwest region and used in a manner of laying and placement that native stone would be used.
5. Highly reflective and polished metals should not be used on the west, south, or east side of a building, particularly next to a pedestrian walkway area, adjacent to streets, or where facing nearby buildings.

ON-SITE CIRCULATION & PARKING AREA DESIGN

2-1.300

In addition to the requirements of the Zoning Ordinance, the following guidelines focus on general and specific techniques to assure safe access, emergency access, and community benefits.

MAJOR DRIVEWAYS

2-1.301

Major driveways provide direct access from the street and into a parking lot with more than 50 spaces, and/or provide the driveway access across the front of a retail center.

Design major driveways:

- A. To have a minimum width of thirty (30) feet from face-of-curb to face-of-curb, and conform to the City of Scottsdale (COS) Maricopa Association of Governments (MAG) details;
- B. Without designated customer and business activity loading areas, and direct parking aisle access near the street intersection;
- C. With adequate vehicle stacking distances where they access public streets;
- D. With adequate site area that will allow fire equipment vehicles to turn-around.
Refer to Section 2-1.303 + 2-1.304;
- E. In coordination with adjacent bus stop locations.

GATED PRIVATE STREET AND DRIVEWAY ENTRANCES

2-1.302

Unless otherwise approved by the Transportation Director, or designee, and the Fire Chief, or designee, gated private streets and driveways shall comply with the following:

- A. Private streets and residential developments
Gated private streets and residential driveways entrances (excluding development in the Downtown Area) shall comply with Figure 2-1.2.

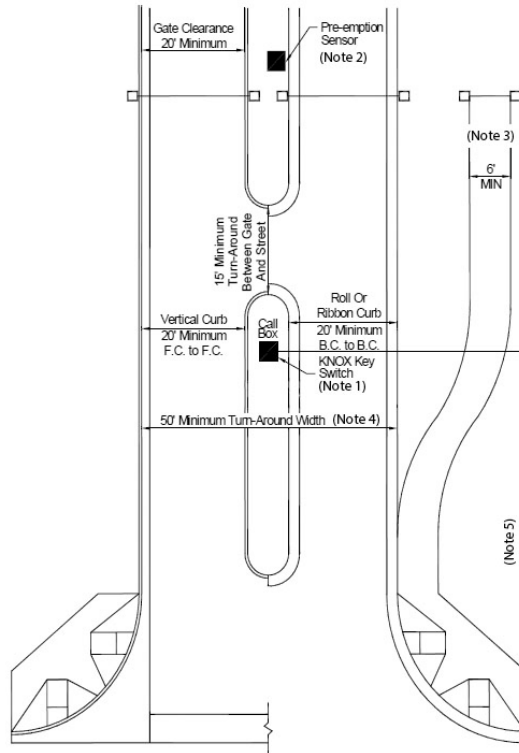
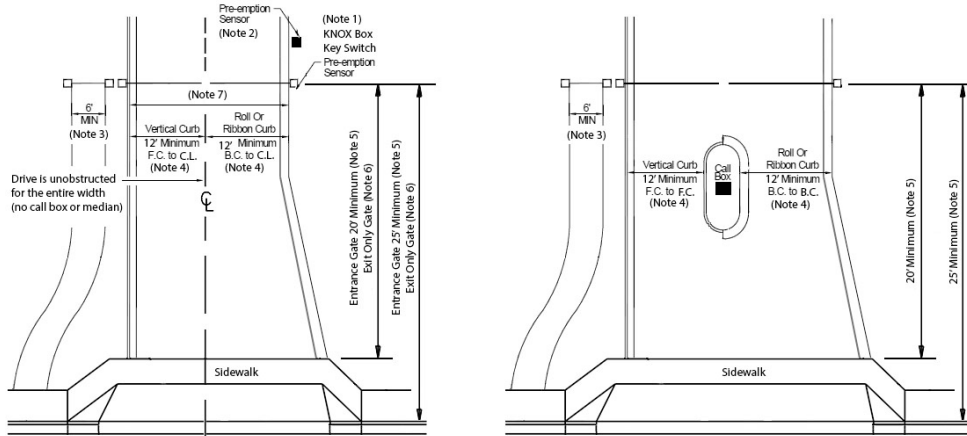

Figure Notes:

1. A KNOX key switch and pre-emption sensor shall be provided on all electric entry control gates. A KNOX key switch shall be installed in a location on the gate control panel (call box) that is readily visible and accessible.
2. The pre-emption sensor shall be at or behind the gate.
3. A separate pedestrian and bicycle access shall be provided on the side of gated vehicular entrance. This may be a gated entrance.
4. The Transportation Director, or designee, may require additional width to accommodate dual entry lanes when the gated entrance is accessed from street classified as an Arterial in the Transportation Master Plan, or a signalized intersection. See note 5.d below pertaining to single entry gated entrances accessed from street classified as an Arterial, or at signalized intersections.
5. The distance from center of the call box:
 - a. To the back of the curb of the street is be a minimum of fifty (50) feet, except as provided in d. and e. below, for:
 - i. Attached and detached residential developments that contain fifty (50) lots or less.
 - ii. Multi-family developments that contain fifty (50) dwelling units, or less.
 - b. To the back of the curb of the street is be a minimum of seventy-five (75) feet, except as provided in d. and e. below, for:
 - i. Attached and detached residential developments that contain fifty (50) lots or greater
 - ii. Multi-family developments that contain fifty (50) dwelling units, or greater.
 - c. Resident or tenant secondary gated private streets and driveways may be approved by the Transportation Director, or designee allowed at 50 feet from center of the call box to the back of the curb of the street, except as indicated in d. below.
 - d. Additional queuing distance from call box to the back of the curb of the street the will be required for gated entrances that are located at signalized intersections or accessing an arterial street.

FIGURE 2-1.2 GATED PRIVATE STREETS AND RESIDENTIAL DRIVEWAYS.

- B. Downtown Area, non-residential developments and exit only gates.
 - 1. Private streets in the Downtown Area, and non-residential development shall comply with Figure 2-1.2.
 - 2. Gated driveways in the Downtown Area, non-residential developments and exit only driveways shall comply with Figure 2-1.3.



A. Unobstructed Gated Driveway Entrance or Exit with Emergency or Service Vehicle Access Through Gated Entrance or Exit.

B. Obstructed Gated Driveway Entrance No Emergency or Service Vehicle Access Through Gated Entrance.

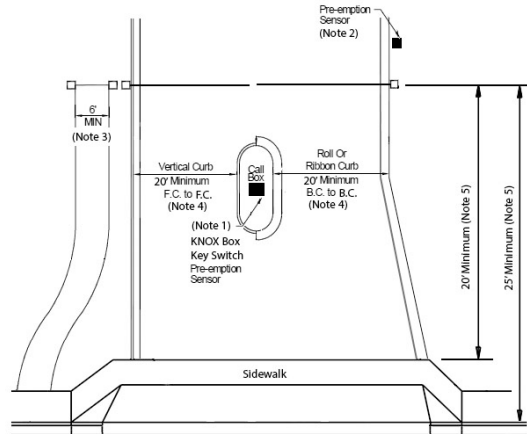

C. Obstructed Gated Driveway Entrance with Emergency or Service Vehicle Access Through Gated Entrance.

Figure Notes:

1. A KNOX key switch and pre-emption sensor shall be provided on all electric entry control gates. A KNOX key switch shall be installed in a location on the gate control panel (call box) that is readily visible and accessible.
2. The pre-emption sensor shall be at or behind the gate.
3. If a separate pedestrian access from to the street to the main entry of the building is not provided, a separate pedestrian and bicycle access is to be provided on the side of gated vehicular entrance. This may be a gated entrance.
4. The Transportation Director, or designee, may require additional width to accommodate dual entry lanes when the gated entrance is accessed from street classified as an Arterial in the Transportation Master Plan, or a signalized intersection. See note 5.a below pertaining to gated entrances accessed from street classified as an arterial street, or at signalized intersections.

5. The minimum distance between the vehicle gate and back of the sidewalk adjacent to the property line shall be twenty (20) feet. At no time shall the minimum distant between the gate and the back of the curb shall be less than twenty-five (25) feet.
 - a. Additional queuing distance from the gate, or call box when provided, to the back of the curb of the street may be required for gated entrances that are located at signalized intersections, or accessing a collector, couplet, or arterial street. Transportation Director, or designee, may require a gated driveway to comply with Figure 2-1.2. when accessing a couplet, or arterial street.
6. Gated exit-only and driveways accessing unclassified, collector, and private streets may be allowed five feet setback from the adjacent sidewalk, or on the property line, whichever setback is greater from the sidewalk, or curb when a sidewalk is not provided. Wall and gates within a required setback or front open space shall not exceed three (3) feet in height. In the Downtown Area, all gates shall be located outside of the required street setback.
7. Minimum width of twenty-four (24) feet from face-of-curb to face-of-curb, or back-of-rolled curb to back-of-rolled curb.

FIGURE 2-1.3 GATED DOWNTOWN AND NON-RESIDENTIAL DRIVEWAYS, AND EXIT DRIVEWAYS

EMERGENCY ACCESS & FIRE LANES

2-1.303

After reviewing the plan for the proposed development, the Fire Department will determine the required fire apparatus access. For complete [Fire Code](#) related issues, please see the city's current adopted Fire Code, amendments, interpretations, and appendixes for guidance.

A. Emergency Access Provisions

1. Fire apparatus access may be provided from public access ways, approved private streets, residential driveways and/or on-site fire lanes. For additional requirements for public access ways, private streets and residential driveways see Section 5-3.000.
2. Design fire lanes around buildings in location that use site driveways and are outside the landscape buffer requirements of Article X of the Zoning Ordinance.

B. Fire Lanes

On-site access (Fire Lanes) for firefighting and emergency vehicle use may be required in addition to the planned public access ways so an emergency vehicle can reach the interior of the development when normal access is blocked. For example, an additional access way may be required due to the number of structures, the square footage of structures, topography (grade), and/or washes and flood plains. See the city's current Fire Code, amendments, interpretations, and appendixes. Emergency access ways shall be secured by an easement. If any emergency access route is intended to be closed and locked, any lock placed on an emergency access gate must be approved by the Fire Department. See COS Standard Detail 2364 for construction and identification of emergency access ways. See Figures 2-1.2 and 2-1.3 for minimum requirements for gated entrances. The following criteria for the lanes shall apply:

1. Fire lane signage must comply with [COS Standard Details](#), Series 2300.
2. The minimum width of a two-way fire lane is 24 feet. One-way lanes, such as divided entrances and drive thru by-pass lanes, shall be 20 feet wide. For project specific information, contact Fire Plan Review. 480-312-2500.

3. The fire lane surface shall be suitable for all-weather use, with a minimum loading design of 83,000 lbs. gross vehicle weight. Where not co-located with vehicular service or access lanes, surfaces other than asphalt such as concrete, paver stones, "grasscrete" and stabilized and compacted crushed granite should be considered.
4. The minimum vertical clearance for the passage of fire department apparatus is 13 feet 6 inches (14 foot is preferred).
5. The minimum radius of all fire lane turns, and the aerial bucket clearance on a turn for commercial, multi-family and single-family residential uses shall comply with Figure 2-1.4. American Association of State Highway and Transportation Officials (ASSHTO) engineered elliptical radius design may be approved in certain circumstances where there are no barriers over 6 feet in height on the outer aerial bucket radius indicated as R4 in Figure 2-1.4. For project specific information, contact Fire Plan Review 480-312-2500.

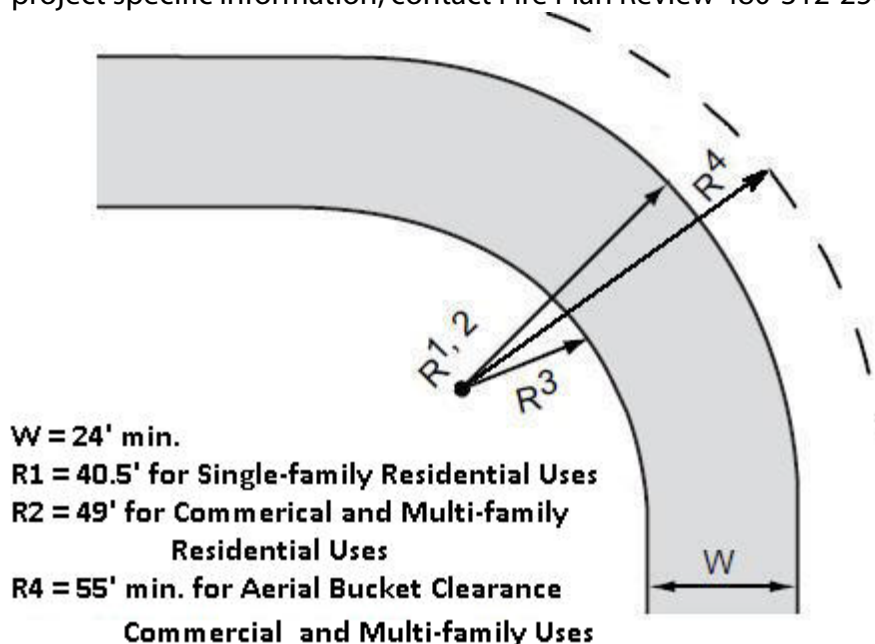

FIGURE 2-1.4 FIRE LANE DIMENSIONS

6. Fire lanes must be posted in accordance with the COS Standard Detail 2365.
7. See Figure 2-1.5 for on-site fire access turnarounds for commercial and residential developments.
8. Provide a turn-around for emergency vehicles at the end of a dead-end parking aisle designated for emergency access (fire lane) if it exceeds 300 feet in length for fire sprinklered structures, 150 feet in length for non-sprinklered structures, as shown by the T-Types in Figure 2-1.5.

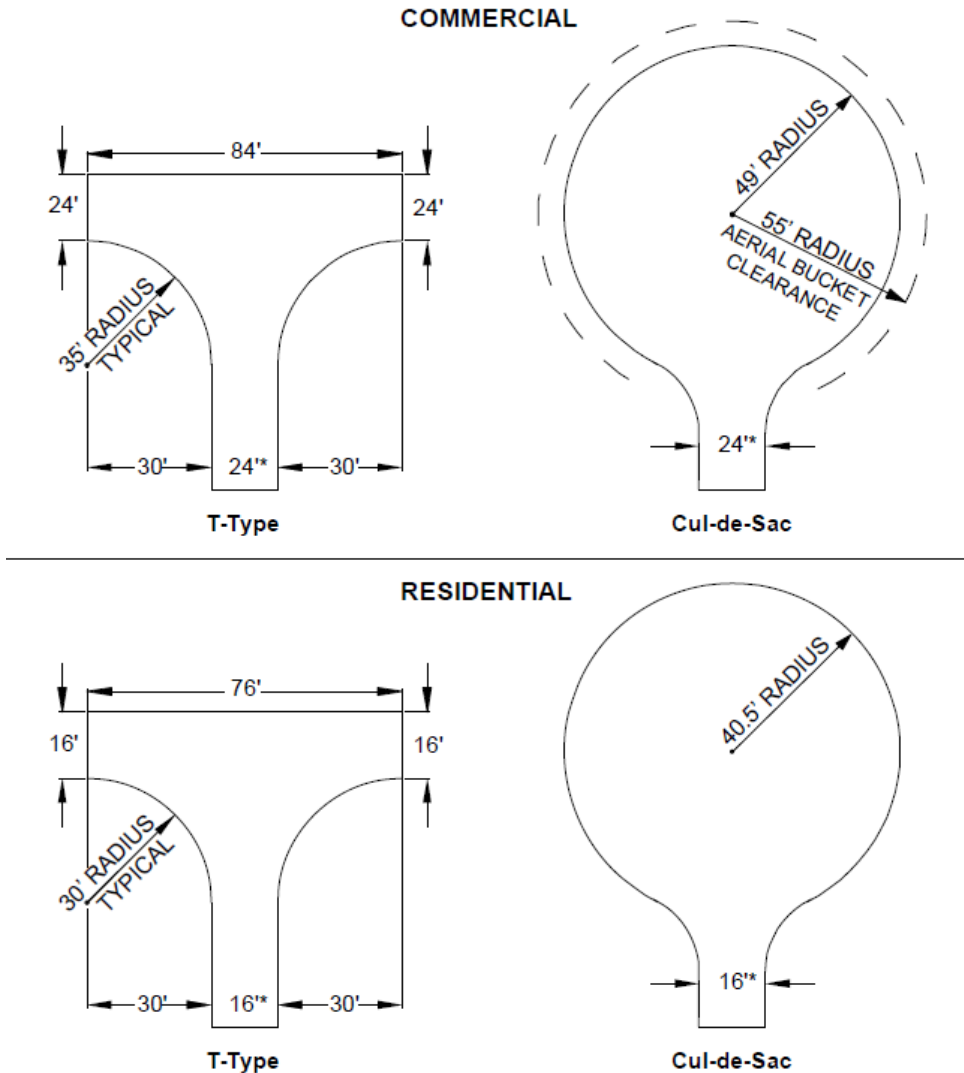

FIGURE 2-1.5 FIRE LANE FIRE ACCESS TURNAROUNDS

DRIVE-THROUGH FACILITIES

2-1.304

Where allowed, locate and design drive-through facilities according to the following criteria:

- A. Do not locate drive-through facilities near residential uses. Screen vehicular storage areas for drive-through facilities placed on the street side of a building, or any other location which is directly visible from adjacent properties with screen walls, mounding, and/or dense landscaping at least four (4) feet in height;
- B. Provide stacking distance for at least 6 vehicles (minimum of 140 feet) for each lane leading into a drive-through facility;
- C. Outdoor speakers at drive-through facilities should not be audible across the property line of the building site. Outdoor speakers should not be placed within 300 feet of a property used for residential purposes; and

- D. Provide a minimum vertical clearance of 98 inches for drive-through facilities.
Provide a minimum vertical clearance of 114 inches for drive-through facilities that include a passenger loading zone.

PARKING AREAS

2-1.305

A. **Parking Spaces**

Design parking space and drive aisles in accordance with the Article IX of the Zoning Ordinance.

B. **Accessible (Handicapped) Parking Spaces**

Design accessible parking spaces in accordance with Article IX of the Zoning Ordinance. See Chapter 12 Disability Access of the Design Standards & Policies Manual (DSPM) for detailed guidance.

C. **Parking Area Landscaping**

Incorporate parking lot landscaped areas and median in accordance with Article X of the Zoning Ordinance.

1. Use landscape plant material that are heat tolerant, have minimal dropping of pods and sap, and have canopies that can have a canopy bottom at least 10 feet above the ground,
2. Use single trunk tree in parking lot landscape areas.

D. **Traffic Control Devices in On-site Parking lots**

When traffic control devices are utilized in on-site parking lots, it is recommended that the general principles and standard traffic control device designs of Federal Highway Administration (FHWA) Manual on Uniform Traffic Control Devices (MUTCD) as modified by the Arizona Supplement to the MUTCD and the Arizona Manual of Approved Signs (MOAS) be used.

E. **Dead-End Parking Aisles**

1. The maximum dead-end parking aisle for designated emergency access length is 300 feet for fire-sprinklered structures, 150 feet for non-sprinklered structures, unless a turn-around is provided for emergency access.
2. Design parking stalls and end of a dead-end parking aisle in conformance with See Figure 2-1.6.

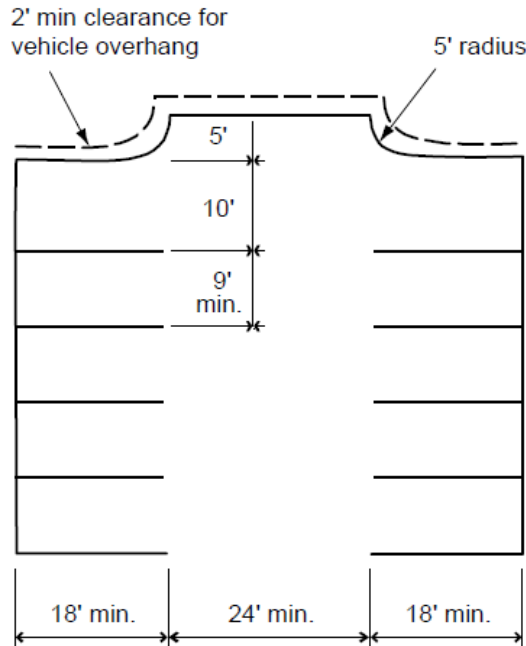

FIGURE 2-1.6 DEAD-END PARKING AISLE DETAIL

F. Off-street Loading Areas

In accordance with Zoning Ordinance, all new development shall provide loading and unloading areas for moving and deliveries approved by the DRB.

1. It is recommended that new and redevelopment of multi-family developments incorporate loading and unloading areas for multi-family and mixed-use development in accordance with Table 2-1.507. F.1. Alleys, fire lanes and streets shall not be used for loading and unloading.

MULTI-FAMILY OFF-STREET LOADING & UNLOADING AREAS	
NO. OF DWELLING UNITS	NO. OF LOADING & UNLOADING AREAS
0 - 50	1*
51 - 150	1
151 - 450	2
OVER 450	3**
* The DRB may approve designating one on-lot parking space for loading and unloading that is 10 feet wide by 18 feet long. Designated spaces shall be signed and striped as loading and unloading areas.	
** Plus, any additional loading areas required by the DRB.	

TABLE 2-1.307. F.1.

The DRB, may approve an alternative to the quantity specified in Table 2-1.303. F.1. when it is demonstrated that the proposed alternative provides adequate loading and unloading area within reasonable and convenient distance to all units.

2. Loading and unloading areas for non-residential use vary based on the use of the building. Incorporate in to the design of a development sufficient space to accommodate the number of trucks that will be loading, unloading or stored at

any one time. Alleys, fire lanes, and street shall not be used for loading and unloading. It is recommended that all non-residential developments incorporate loading and unloading areas in accordance with Table 2-1.307. F.2.

NON-RESIDENTIAL OFF-STREET LOADING & UNLOADING AREAS	
GROSS FLOOR AREA (FT ²)	NO. OF LOADING & UNLOADING AREAS
LESS THAN 30,000	1*
30,001 TO 100,000	1
100,001 TO 200,000	2
OVER 200,000	3**
* For each 10,000 square feet of gross floor area of a development project, the DRB may approve designating one on-lot parking space for loading and unloading that is 10 feet wide by 18 feet long. Designated spaces shall be signed and striped as loading and unloading areas.	
** Plus, any additional loading areas required by the DRB.	

TABLE 2-1.307. F.2.

The DRB, may approve an alternative to the quantity specified in Table 2-1.307. F.2. when it is demonstrated that the proposed alternative provides adequate loading and unloading areas within reasonable and convenient distance to all tenant areas.

3. Design loading and unloading area(s) are to have minimum length of forty-five (45) feet long to accommodate a thirty (30) foot long single-unit trunk and fifteen (15) truck loading and unloading areas. Smaller loading areas may be approved in accordance with Tables 2-1.307. F.1. and 2-1.307. F.2. Large condominium (condo) and mixed-use developments, and non-residential development should provide off-street loading and unloading area(s) designed to accommodate a sixty-five (65) foot long semi-trunk with a fifteen (15) truck loading and unloading areas.
4. Design the minimum width of a loading and unloading area(s) to be twelve (12) feet wide, and to have a vertical clearance of thirteen (13) feet six (6) inches, although vehicle clearance of fourteen (14) feet inches is recommended.
5. Design the loading and unloading area(s) so that entire length and width of the loading area does not obstruct driveways and parking areas or create traffic conflicts. Loading area shall be not included number of a development's provided parking.
6. Loading and unloading area(s) within a multi-story building shall have direct access into the internal circulation system and elevator(s).

G. Parking Surfacing

Use asphaltic pavement, concrete, or a similar material approved by the DRB for all parking areas for commercial, office, industrial, and multi-family. At a minimum, use dust palliatives or other surfacing materials that minimize the generation of fine dust particulates for single family residential and equestrian facility parking areas.

At a minimum, use a stable dust-free material on drive aisles of places of worship, event centers, parks, trailheads, and other recreational facilities. The parking stalls may be improved with a soil mix treated with a dust palliative. In such installations all parking areas shall be contained by concrete curbing.

H. **Dust Control Measures on Unpaved Surfaces**

The following section outlines dust control regulations present in the Maricopa County Air Quality Department Rule 310.01 and Chapters 18, 19 and Zoning Ordinance, Article VII Section 7-900 of the SRC.

This information is intended to assist owners/operators responsible for controlling dust on disturbed and/or unpaved surfaces. Note that other requirements apply to permitted construction or demolition activity. (Dust control permits are necessary for any activity that disturbs a surface area greater than 0.1 acres or involves building demolition.)

1. Exemption

Dust free surfaces are exempt. A dust free surface is an area completely covered by concrete, asphalt, cement or sealed aggregate pavement; three (3) inches deep crushed rock completely contained in a permanent border; and/or another stabilization material approved by the city. All other surfaces are unpaved surfaces.

2. Dust Control Measures

Options fall into two categories: materials and methods. The "materials" list describes construction materials, elements, and techniques used to limit dust emissions. The "methods" list includes land use options, such as preventing access, limiting traffic, etc. Property owners and/or operators should review the following options and determine which material(s) and/or method(s) would be appropriate. Multiple options and combinations of options are often most effective. All dust control measures shall be maintained as appropriate to effectively control dust.

a. Materials:

- i. Watering
- ii. Stabilization with gravel or decomposed granite
- iii. Stabilization with recycled asphalt paving
- iv. Stabilization with wood chips or other organic matter
- v. Dust suppressant/chemical stabilization application
- vi. Standing vegetation
- vii. Flat vegetative cover
- viii. Grass
- ix. Wind Fences
- x. Wind Screens
- xi. Curbed perimeter
- xii. Track out devices
- xiii. Paved access points
- xiv. Other

b. Methods:

- i. Increase frequency and/or intensity of watering if dust is not controlled

- ii. Increase frequency/intensity of watering during high wind conditions
 - iii. Limit vehicle access
 - iv. Reduce vehicle speed
 - v. Cease parking temporarily
 - vi. Other
3. Dust control for ingress, egress, parking, and maneuvering areas at residential and commercial developments (SRC, Section 46-17 Surfacing)
- a. Reduce/delineate the area used for ingress, egress, parking, and maneuvering by:
 - i. Eliminating circular drives
 - ii. Use of only one ingress/egress
 - iii. Installing barriers such as boulders or logs to delineate driving areas
 - iv. Installing shrubs, trees, berms, or other effective landscape which would reduce the driving area
 - b. Reduce dust from areas that will be utilized by motorized vehicles on a regular basis by:
 - i. Applying and maintaining surface gravel or decomposed granite
 - ii. Applying and maintaining dust palliatives, chemical stabilizers, or similar dust control materials
 - iii. Watering frequently
 - iv. Applying and maintaining organic stabilizers
 - v. Installing and maintaining vegetative ground cover. Examples include native grasses, shrubs, trees, vines, or vegetative debris that is not subject to movement by wind.
 - vi. Paving with asphalt, concrete, or other similar material including porous asphalt or concrete
 - vii. Posting 5 mile per hour speed limit signage, and maintaining slow speeds
 - viii. Alternative methods may be approved by city staff that comply with Maricopa County's Air Quality Department requirements.
4. Dust control for vacant lots and open areas where vehicle trespass has occurred (Sec. 18-9.2 and 19-14 of the SRC)
- a. Reduce the area available to motorized vehicles by:
 - i. Posting no trespassing signs
 - ii. Installing barriers or curbs with city approval
 - iii. Installing fences, gates, or posts with city approval
 - iv. Creating landscape berms
 - v. Installing shrubs, trees, or other effective landscape which would prohibit access
 - b. Reduce dust from where motorized vehicle use has occurred by:
 - i. Applying and maintaining surface gravel or decomposed granite
 - ii. Applying and maintaining dust palliatives, chemical stabilizers or similar dust control materials
 - iii. Watering to form a soil crust
 - iv. Applying and maintaining organic stabilizers

- v. Installing and maintaining vegetative ground cover. Examples include native grasses, shrubs, trees, vines, or vegetative debris that is not subject to movement by wind.
 - vi. Paving with asphalt, concrete, or other similar material including porous asphalt or concrete
 - vii. Posting 5 mile per hour speed limit signage, and maintaining slow speeds
 - viii. Using other methods as approved by Maricopa County and the city
5. Dust control for temporary parking on vacant lots and open areas, including for special events (SRC, Zoning Ordinance, Article VII Section 7.900).

Vacant lots and open areas that are used for temporary parking, including parking for special events, shall comply with these requirements before, during, and after the special event or land use as temporary parking. After the vacant lot and/or open area has been used for parking, the property owner and/or operator shall permanently stabilize all portions of the lot where vehicle use disturbed the surface. The property owner and/or designee shall thereafter comply with the requirements of Sec. 2-1.709 E. 2. for dust control on vacant lots and open areas.

The owner and/or operator shall complete a dust control plan for temporary parking using the form provided by the city and/or following city guidance and submit it along with the other requirements for a Special Event Permit or as a standalone requirement. The plan shall include primary and contingency dust control measures, a commitment to control and clean up track out onto paved surfaces, and measures to permanently stabilize the area disturbed by vehicle use after the vacant lot or open area has been used for temporary parking.

Appropriate dust control measures, both materials and methods are listed in Sec. 2-1.709 E. 2. a. and b. Permanent stabilization must be accomplished using the dust control materials listed in Sec. 2-1.709 E. 2. a. Track out control devices, approved by the city must be used at all ingress/egress points and traffic controlled at the site to use only designated ingress/egress points.

Any track out that extends 25 feet or more onto a paved surface must be cleaned up immediately, and all track out of any length must be cleaned up at the end of the day. The intent of these requirements is to keep city requirements equivalent to Maricopa County Air Quality Department Rule 310.01 Sec. 302.5 and 302.6 related to vacant lots and open areas and parking. These dust control methods are effective when appropriately applied although the effectiveness may vary based upon individual circumstances. Other dust control methods may be acceptable based on review and approval by Maricopa County Air Quality Department and the city.

CORRIDORS & STREETSCAPES

2-1.306

Scottsdale has developed specific design guidelines for the dimensions, use and design elements of many natural open space and streetscape corridors. Refer to the city's General Plan or website for information on the location of the [streetscape corridors and the Scenic Corridor Design Guidelines](#). These guidelines should be addressed in addition to the specific criteria identified below.

A. Open Space Corridors

There are four main categories of streetscape open space corridors for which guidelines have been developed: scenic corridors, buffered setbacks, vista corridors, and desert scenic roadway setbacks. The locations are identified in the General Plan and/or have been required as a part of zoning stipulations.

1. **Scenic Corridors:** These are corridors along selected major streets where there is a desire by the community to retain views of nearby terrain features and retain the character of the natural desert setting.
 - a. Carefree Highway - Scottsdale Road to the city's western boundary – 2 miles.
 - b. Cave Creek Road - Pima Road to the city's northeast boundary – 3.5 miles.
 - c. Dynamite Boulevard - 56th Street to the city's eastern boundary – 10.5 miles.
 - d. Pima Road - North of the Loop 101 to Cave Creek Road – 11 miles.
 - e. Scottsdale Road - North from Frank Lloyd Wright to Carefree Highway – 11 miles.
 - f. Shea Boulevard - Pima Freeway to the city's eastern boundary – 9 miles.
2. **Buffered Setbacks:** These are corridors along significant streets where there is intent by the community to achieve an open, naturally vegetated, desert, scenic boulevard type of effect, recognizing the importance of the roadway in the local setting.
 - a. Frank Lloyd Wright Boulevard – Scottsdale Road to Shea Boulevard – 6 miles
 - i. Setbacks: 40 feet average; 30 feet minimum
 - ii. Streetscape Character: Desert landscape materials; saguaro is theme plant
 - iii. Specific design criteria: Yes (See Frank Lloyd Wright Boulevard Design Guidelines)
 - b. Via Linda – Central Arizona Project (CAP) Aqueduct to 140th Street – 3 miles
 - i. Setbacks: 40 feet average; 30 feet minimum
 - ii. Streetscape character: Native Sonoran Desert materials
 - iii. Specific Design Criteria: (See Via Linda Streetscape Guidelines)
 - c. Hayden Road – Thunderbird Road to Frank Lloyd Wright Boulevard. – 1.7 miles
 - i. Setbacks: 50 feet from Thunderbird Road to 83rd Place transitioning to 25 feet at Northsight Boulevard
 - ii. Streetscape Character: Semi-arid and desert landscape materials
 - iii. Specific Design Criteria: open, no walls, natural contours
 - d. Thompson Peak Parkway – Frank Lloyd Wright Boulevard to Scottsdale Road – 6.7 miles
 - i. Setbacks: 25 feet from Frank Lloyd Wright Boulevard to the CAP Aqueduct; 40 feet elsewhere except between Legacy Boulevard and Windgate Pass Road

- ii. Streetscape Character: Semi-arid materials between Frank Lloyd Wright Boulevard and the CAP Aqueduct and native Sonoran Desert materials elsewhere, except between Legacy Boulevard and Windgate Pass Road
 - iii. Specific Design Criteria: open, no walls, natural contours
 - e. Bell Road – Loop 1010 Freeway to Thompson Peak Parkway – 1.5 miles
 - i. Setbacks: 50 feet
 - ii. Streetscape Character: Native Sonoran Desert materials
 - iii. Specific Design Criteria: open, no walls, natural contours
 - f. Lone Mountain Road – Scottsdale Road to Cave Creek Road – 4.2 miles
 - i. Setbacks: 25 feet for individual single-family lots, and 40-50 feet for subdivisions
 - ii. Streetscape Character: Native Sonoran Desert materials
 - iii. Specific Design Criteria: open, no walls, natural contours
- 3. **Desert Scenic Roadways Setbacks:** All major mile and half-mile streets (not designated as a Scenic Corridor by the General Plan) within the Environmentally Sensitive Lands Overlay zoning areas of the city shall provide an average 50-foot-wide open space corridor along the edge of the street right-of-way. There shall be no buildings, walls, fences, or parking areas within this corridor. The Desert Scenic Roadway Setback may provide a minimum of a 40-foot width for 25 percent of the street frontage. All landscape improvements within this corridor shall be natural desert or native plant materials. Exception: Along 128th street, from Dynamite Road south to the Pinnacle Peak Road section line, there shall be a 100-foot wide scenic easement as measured from the right-of-way line provided on both sides of the roadway
- 4. **Vista Corridors:** These are corridors along major washes and channels that are intended to provide local and community vistas of nearby terrain and the desert setting as well as provide access corridors to neighborhoods, parks and schools.
 - a. Location Criteria: These corridors are depicted in the General Plan or have been required as a part of zoning stipulations. In general, any wash or channel that is north of Doubletree Ranch Road section line and has a 100-year storm flow of 750 cubic feet per second (cfs) or greater is designated as a Vista Corridor.
 - b. Minimum Width: 100 feet, unless there are defined wash or channel banks that are farther apart, in which case the corridor edge will be located 10 feet beyond the top of bank.
 - c. Applicability as Open Space: These corridors may be credited as required open space or natural areas open space, as specified in the applicable zoning standards.
 - d. Landscape Character: These corridors are to be kept in as natural a condition as is possible. Any landscaping or restoration within the corridor shall return the area as much as possible to a natural condition.
 - e. Walls:
 - i. Solid walls shall not be constructed within a Vista Corridor easement.

- ii. Solid, opaque walls that are proposed to be taller than three (3) feet shall be set back four (4) feet from the Vista Corridor easement line for every one (1) foot of solid, opaque wall height that is greater than three (3) feet in height. No solid, opaque wall along a Vista Corridor shall exceed 6 feet in height.
 - iii. Open view fencing is allowed adjacent to the Vista Corridor easement.
- B. Streetscapes**
1. [Specific design guidelines](#) have been developed for a number of major streets. These generally focus on the design of landscaping and street furniture along the edges and medians of these streets:
 - FRANK LLOYD WRIGHT BOULEVARD
 - VIA LINDA
 - SCOTTSDALE ROAD
 - MCDOWELL ROAD
 - SHEA BOULEVARD
 - CACTUS CORRIDOR
 2. All improvements within a scenic corridor, buffered setback, or desert scenic roadway setbacks that are not covered by the design guidelines above, shall be designed in conformance with the Scenic Corridor Design Guidelines.

GARAGES AND CARPORTS

2-1.307

- A.** In accordance with Article IX of the Zoning Ordinance, parking spaces adjacent to a wall, or an obstruction greater than six (6) inches, shall be enlarged by two (2) feet, for a total of an eleven (11) foot wide parking stall, unless there is a minimum three (3) foot wide sidewalk or access aisle between the wall or obstruction. Parking stall width in a parking structure shall comply with the Figure in the Zoning Ordinance. Unobstructed interior width of garages and carport shall comply with the Zoning Ordinance as illustrated in Figure 2-1.7.

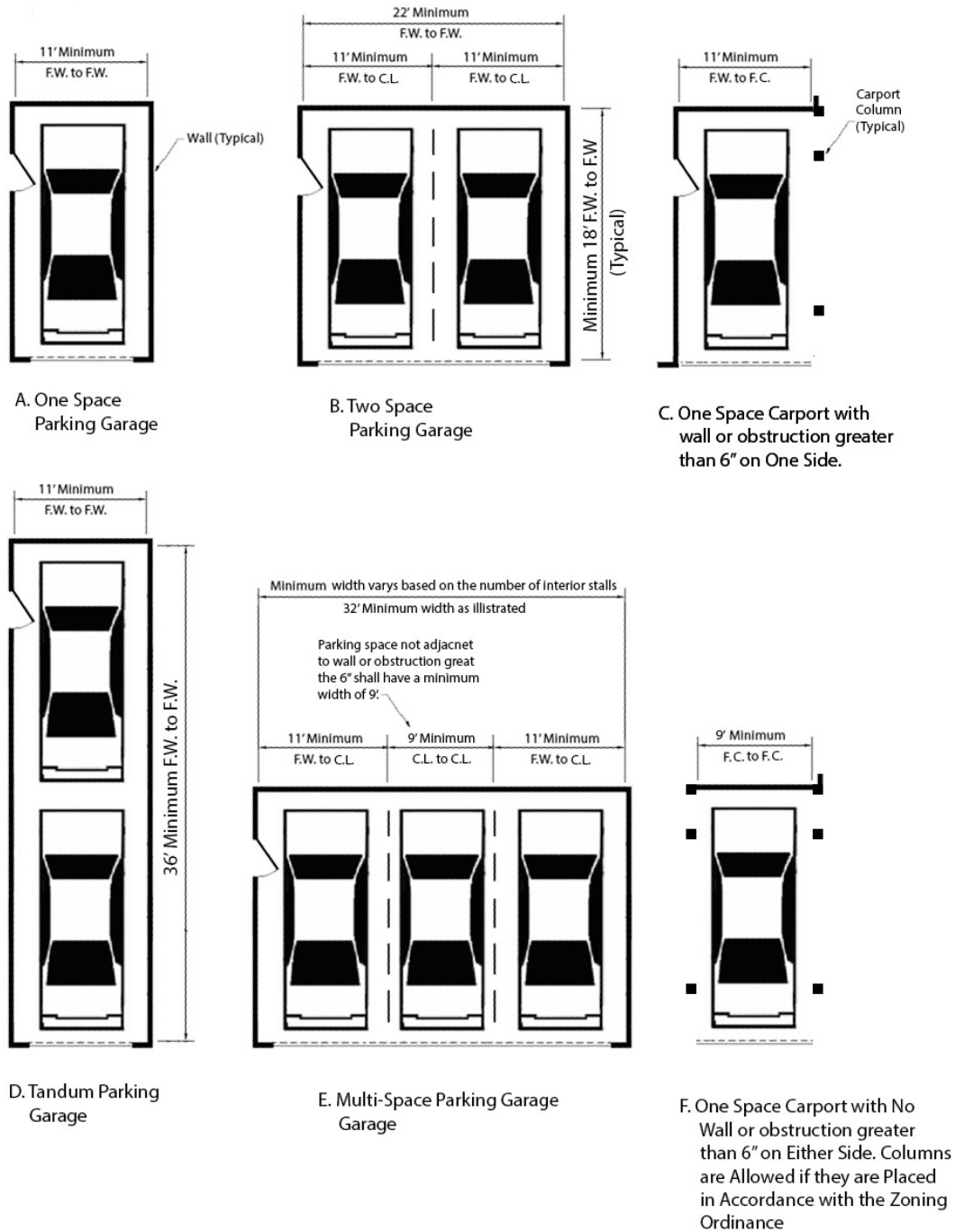
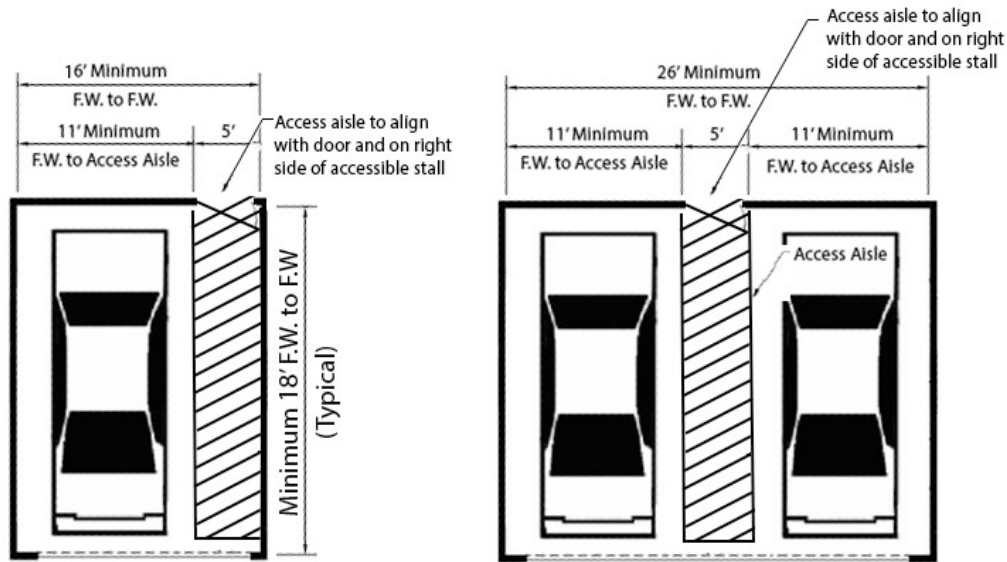

FIGURE 2-1.7 GARAGE AND CARPORT PARKING WIDTH

B. In accordance with Article IX of the Zoning Ordinance, multiple dwelling development projects are to provide accessible parking spaces in adaptable garages at the same percentage that standard parking is provided into the garage. Adaptable garages are to be constructed with a minimum vertical clearance of ninety-eight inches, and in conformance Article IX of the Zoning Ordinance as illustrated in Figure 2-1.8.



A, One Space Adaptable Accessible Parking Garage

B. Two Space Adaptable Accessible Parking Garage

FIGURE 2-1.8 ACCESSIBLE PARKING SPACES IN ADAPTABLE GARAGES

Attached individual single-family dwellings with each dwelling on a separate lot, with party walls and no side yards between abutting dwellings, do not need to comply with Section 2.1-509. B., unless required by the Joint Statement of The Department of Housing and Urban Development (HUD) and The Department of Justice dated April 30, 2013 pertaining to accessible multifamily, townhouse, and carriage dwellings.

- C. Where garages are within 6 to 18 feet of the driveway or pedestrian way there is a tendency for people to try to park in such space. In doing so, the vehicle blocks, or at least impinges, into the driveway and pedestrian walkways. To discourage ad hoc parking (whether parallel or head-in) that blocks or impinges the driveways and pedestrian walkways, the face of a garage door shall be in accordance with the following:
 - 1. Garages for residential developments (excluding single family residential districts) that are adjacent to a driveway with the face of the garage door parallel to the driveway, shall have the face of the garage door setback:
 - a. three (3) feet from the back of the adjacent:
 - i. sidewalk that is provided between the driveway and the garage; or
 - ii. back of curb where a sidewalk is not provided between the driveway and the garage.
 - b. two (2) feet from right-of-way of an alley.
 - c. in accordance with Table 2-1.309. C.2. when the garage door is placed at any other angle, or when garage a door is parallel to drive, and is placed at a distance greater than three (3) feet as indicated in a. above.
 - 2. Garages for residential developments (excluding single family residential districts) that adjacent to a private or public street shall have the face of the garage door setback in accordance with the Table 2-1.309. C.2.

TABLE 2-1.309. C.2.

GARAGE DOOR AND CARPORT ENTRANCE SETBACK

Angle of Garage Door or Carport Vehicle Entrance to Public or Private Street (Degree)	Minimum Garage Door or Carport Vehicle Entrance Distance to a Sidewalk Adjacent to a Public or Private Street (in feet)	Minimum Garage Door or Carport Vehicle Entrance Distance to the Back of Curb of a Public or Private Street with No Sidewalk (in feet)	Minimum Garage Door or Carport Vehicle Entrance Distance to the Right-of-Way of a Public Street or Private Street Tract (in feet)
0 (parallel) to 29	20	20	18
30 to 44	17	17	15
45 to 59	14	14	13
60 to 75	5	5	4
76 to 90	3	3	2

Note: Furthest separation shall govern

3. Where garages are placed three (3) to five (5) feet back from the traveled way, it may be advisable to have a light above or next to the garage door that would flashes when the door is open to give notice to drivers in the traveled way of a potential conflict.

BICYCLE PARKING FACILITIES

2-1.308

- A. Provide bicycle parking facilities at the rate specified in the Article IX of the Zoning Ordinance for all multi-family and non-residential uses.
- B. Located bicycle parking facilities at the building entrance(s) in accordance with the Zoning Ordinance, and in a convenient, highly visible, location. In the Downtown Area, bicycle parking spaces may be provided within a common location that is obvious and convenient for the bicyclist. On a site with several businesses, bicycle parking should be dispersed to be convenient for each business entry. A portion of the required parking may be located by an employee entrance.
- C. Place the bicycle parking facilities so that the rack and bicycle staging area around the rack does not interferes with sidewalks and pedestrian access into the building.
- D. The bicycle parking facilities should be well lit and wherever possible in shaded location.
- E. The bicycle rack may be painted and may be placed on concrete, turf or gravel.
- F. Bicycle racks shall be U-shaped in conformance with the COS MAG Detail 2285. Alternative bike rack designs may be approved by the Zoning Administrator. At a minimum, alternative bike rack designs should comply with the following:
 1. Easy to use without instructions;
 2. Securely support the entire frame of the bike by allowing numerous contact points on one plane with the frame and one wheel, with those points being spread out both horizontally and vertically;

3. Reasonable accommodation of any size or type of bicycle with any type of luggage or equipment;
4. Does not require that the bicycle to be lifted or supported by a kickstand;
5. Allows for use of a secure locking mechanism with any type of lock or cable, including the "U" locks.
6. If the front wheel of the bicycle is removed and repositioned, then it should be possible to lock the frame and both wheels to the rack.
7. The rack should not require that the lock be fastened close to the bicycle chain.
8. Each rung accommodates two (2) bicycles. An inadequate design, such as the "ribbon" or "wave" rack, will not approved since these rack types allow bikes to be placed either perpendicular or parallel to the rack and reduces the effective parking spaces for two (2) bikes.

REFUSE COLLECTION

2-1.309

The Solid Waste Management Director or designee must approve all solid waste collection methods for commercial (typically non-residential, mixed-use, and multi-family residential developments) and residential services (typically detached single-family and attached duplex single-family dwellings). Unless otherwise approved by the Solid Waste Management Director or designee, all solid waste collection methods for commercial and residential services shall be designed to these city standards.

A. **Non-Residential, Mixed-Use, and Multi-Family Residential Refuse and Recycling Enclosure Location and Design**

1. Locate and design the refuse and recycling enclosures based on the following criteria:
 - a. Refuse enclosures shall comply with applicable COS MAG Standard Details #2146-1, 2146-2, 2147-1 and 2147-2.
 - i. No underground "vault-type" containers will be approved.
 - ii. Modifications to the COS MAG Standard Details and alternative designs may be approved by the Sanitation Director, or designee.
 - b. All restaurants and bars that serve food must provide enclosures with grease containment areas in accordance with the COS MAG details and Table 2-1.311. B.
 - i. The grease containment area must be physically separated from the refuse container portion of the enclosure.
 - ii. Sanitation Director, or designee may approve alternative grease containment area locations or designs.
 - c. Locate and position the enclosure(s):
 - i. Approach pad so that the refuse truck route to and from the public street has a minimum unobstructed vertical clearance of thirteen (13) feet six (6) inches (fourteen 14 feet is recommended), and unobstructed minimum vertical clearance above the approach pad and refuse enclosure of twenty-five (25) feet(The vertical clearances are subject to modification based on enclosure container size, location and positioning as determined by the Sanitation Director, or designee.)
 - ii. In a location that is easily accessible for collection, and does not require the refuse truck to "backtrack";

- iii. A maximum 100 feet distance for building service exit to refuse enclosure;
- iv. So that collection vehicles do not back up more than thirty-five (35) feet; or,
- v. So that path of travel for the refuse truck accommodates a minimum vehicle of turning radius of 45 feet, and vehicle length of 40 feet.
- d. Design the refuse enclosure(s) and approach pad to be level, with a maximum of a two (2) percent slope.
- e. Do not place the enclosure(s):
 - i. Between the on-site buildings and adjacent lower density residential uses unless there is no reasonable alternative. In these situations, orient the enclosure toward the interior of the property;
 - ii. Next to drainage ways or basins, unless there is no reasonable alternative;
 - iii. Between the street and the front of the building unless there is no reasonable alternative; or,
 - iv. At the end of a dead-end parking aisle.
- f. Gates across the front of an enclosure are generally discouraged. If desired, an enclosure with gates shall be designed to accommodate full ADA access. Refer to Chapter 12.
- g. If a refuse or recycling container is taller than the enclosure screen wall, the screen shall be raised to one foot taller than the container.

B. Required Number of Non-Residential, Mixed-Use, and Multi-Family Residential Refuse and Recycling Enclosures.

- 1. Non-Residential, Mixed-Use, and Multi-Family Residential developments shall provide the refuse enclosures in accordance with Table 2-1.311. B. Non-Residential, Mixed-Use, and Multi-Family Residential developments are encouraged to incorporate recycling of reusable refuse material with in the design of a building and provide Refuse and Recycling Enclosures in accordance with Table 2-1.311. B.

TABLE 2-1.311. B.		
USE	REQUIRED NUMBER OF REFUSE ENCLOSURES WITHOUT RECYCLING	REQUIRED NUMBER OF REFUSE ENCLOSURES WITH RECYCLING
Non-Residential Development	1 enclosure for each 20,000 square feet of building space or portion thereof per COS Standard Details #2146-1 or 2147-1	2 enclosures for each 30,000 square feet of building space or portion thereof per COS Standard Details #2147-1 or 2147-2
Apartments & Condominiums	1 enclosure for every 20 units or portion thereof per COS Standard Details #2146-1 or 2147-1	2 enclosures for every 30 units or portion thereof per COS Standard Details #2146-1 or 2147-1

TABLE 2-1.311. B.		
USE	REQUIRED NUMBER OF REFUSE ENCLOSURES WITHOUT RECYCLING	REQUIRED NUMBER OF REFUSE ENCLOSURES WITH RECYCLING
Restaurants / Bars	1 enclosure with a grease containment Area per COS Standard Details #2146-2 or 2147-2	1 enclosure with a grease containment Area and 1 enclosure without a containment Area per COS Standard Details # 2147-2
Mixed-use Development (Non-Residential with Residential)	1 enclosure for first 10,000 square feet of non-residential building area and the first 10 units or portion thereof per. Where additional non-residential building square footage area and units are provided, 1 enclosure for each additional 20,000 square feet of non-residential floor area, and 1 enclosure additional for each 20 units or portion thereof. Restaurants and Bars that serve food shall provide separate refuse enclosures.	2 enclosures for first 15,000 square feet of non-residential building area and the first 15 units or portion thereof per. Where additional non-residential building square footage area and units are provided, 2 enclosures for each additional 30,000 square feet of non-residential floor area, and 2 enclosures additional for each 30 units or portion thereof. Restaurants and Bars that serve food shall provide separate refuse enclosures.

C. Refuse and Recycling Containers

1. Containers shall comply with Chapter 24 of the SRC.
2. Containers with casters shall not exceed 4 cubic yards. The Sanitation Director, or designee may approve alternative container sizes with casters.

D. Refuse Compactors

The Solid Waste Management Director, or designee may approve refuse compactors as an alternative to refuse or recycling containers which may include an alternative ratio of refuse or recycling enclosures specified in Table 2-1.311. B.

E. Rear Loaded Non-Residential, Mixed-Use, and Multi-Family Residential Compactor Container Positioning

1. Design the location of the refuse or recycling compactor container and loading and maneuvering area so that the container and refuse truck does not obstruct any portion of designated fire lane or an emergency and service vehicle access lane during loading, unloading, and placement of the container.
2. Place the refuse compactor container and approach pad so that the refuse truck route to and from the public street has a minimum unobstructed vertical

clearance of thirteen (13) feet six (6) inches (fourteen 14 feet is recommended), and unobstructed minimum vertical clearance above the concrete approach slab and refuse compactor container storage area concrete slab of twenty-five (25) feet.

The vertical clearances are subject to modification based on container size, location and positioning as determined by the Sanitation Director, or designee.

3. Place the refuse compactor container in a location that does not require the bin to be maneuvered or relocated from the bin's storage location to be loaded on to the refuse truck.
4. Provide a refuse compactor container approach area that has a minimum width of fourteen (14) feet and length of sixty (60) feet in front of the container. The length of the approach is subject to modification based on the enclosure location, drainage, and positioning concerns. The approach length and width are subject to modification based on container size, location and positioning as determined by the Sanitation Director, or designee.
5. Provide the refuse compactor container approach and storage areas with a maximum continuous slope of two (2) percent.
6. Incorporate a concrete approach slab (minimum thirty (30) feet long) and refuse compactor container storage area concrete slab (minimum four (4) feet longer than the container) that are, at a minimum, in compliance with the concrete slab requirements of the COS MAG Details for a refuse enclosure. The property owner and their designers are responsible for determine when a greater capacity concrete slab and structural design is required and shall modify the design indicated in the COS MAG Details to accommodate the design of the building, refuse truck, refuse compactor container, etc. The length of the concrete approach slab is subject to modification based on enclosure location, drainage, and positioning as determined by the Sanitation Director, or designee.

F. Shared Refuse Agreements

1. Except for bars and restaurants, shared refuse agreements may be allowed as refuse solutions in the Downtown Area.
2. All shared refuse agreements are subject to review and approval by Planning and Development Services, Solid Waste Management, and the City Attorney's office.
3. A city refuse enclosure must exist, or be constructed, as part of the shared refuse agreement and comply with applicable COS MAG Standard Details.

G. Single-family Residential Refuse and Recycling

1. Single-family detached residential subdivisions shall be designed to accommodate the city residential collection requirements.
2. Design dedicated storage areas for refuse and recycling containers that are screened from view from the adjacent street, and not within enclosed livable areas.
3. Design development so that the refuse and recycling containers have a location that accessible for service.

4. Design residential development so that the refuse and recycling containers collection does not occur on private driveways, hammerhead streets, or dead-end streets.
5. Design single family developments so that refuse and recycling containers are accommodated at the street curb on collection days. Alley refuse collection requires separate written agreement and approval from the Solid Waste Director, or designee.
6. The property owner of a residential subdivisions with gated entrances shall dedicate unrestricted dedicate access within the development project to allow for refuse and recycling collection services. Dedicated access shall be in the form of an Emergency and Service Vehicle Access Easement dedicate to the city.

PEDESTRIAN ACCESS ROUTE TO STREETS

2-1.310

- A. All non-residential and multi-family developments shall provide an accessible pedestrian access route from the main entry of the development to each abutting public and private street that provides a pedestrian sidewalk or multi-use trail. The pedestrian access route shall be a sidewalk that has minimum width of six (6) feet or five (5) feet if the existing sidewalk abutting public and private street is five (5) feet or less. In cases where a sidewalk width of six feet cannot be provided due to existing physical barriers or other constraints, a clear and continuous sidewalk width of five (5) feet may be by the Planning and Development Director or designee. Accessible routes to streets shall be provided in accordance with Chapter 12 of the DSPM.
- B. The on-site pedestrian access route(s) should be provided along at least one side of a site driveway to each street. The use of a driveway as the pedestrian access route to connect to a pedestrian sidewalk or multi-use trail adjacent a public and private street is discouraged.

PEDESTRIAN ACCESS ROUTE TO MULTI-USE TRAILS

2-1.311

The pedestrian access routes of a new development, redevelopment, and reconstruction of a property, are encouraged to connect to multi-use trails that are adjacent to the property. In accordance with Chapter 12 of the DSPM, the pedestrian access route and trail connection shall be accessible when required.

PEDESTRIAN CIRCULATION WITHIN A DEVELOPMENT

2-1.312

- A. The three levels of pedestrian circulation within a site are:
 1. Primary Pedestrian Circulation Route.
 2. Primary Pedestrian Circulation Routes are generally pedestrian sidewalks to the main building entry.
 - a. Non-residential development. A primary pedestrian circulation route is the main pedestrian connection between adjacent streets that have sidewalks or multi-use trails adjacent to them, parking and the main pedestrian entry of buildings, and between the main pedestrian entries of different buildings in a development. In developments that have more than one building, a primary pedestrian circulation route is not required between the main

- operations building and a secondary operations building that is not generally accessible to the public.
- b. The main building entry shall be connected to the main parking lot by a primary pedestrian circulation route that connects to the street(s) and other main building entries. Additional secondary pedestrian circulation routes may be provided from the main building entry to secondary parking lots that are typically behind or to the side of buildings. Refer to Section 2-1.314. A.1.d.
 - c. Multi-family development. A primary pedestrian circulation route is the main pedestrian connection throughout the development that connects the residential buildings, parking, common amenities, adjacent streets that have sidewalks or multi-use trails adjacent to them and the development office (if provided). Typically, each development has a minimum of one primary pedestrian circulation route; although, due to size and orientation of the development, additional primary pedestrian circulation routes may be necessary.
 - d. A primary pedestrian circulation route shall be provided from the adjacent street(s) that have sidewalks or multi-use trails adjacent to them and from the parking lot to the development office.
 - e. Retail centers and mixed-use buildings. Provide a minimum unobstructed continuous eight (8) foot wide primary pedestrian circulation route in front of the storefronts of major retail centers and mixed-use buildings. In locations where canopy supports, patios, or other physical barriers encroach into the adjacent pedestrian circulation route, provide a twelve (12) foot wide sidewalk with a continuous width of eight (8) feet; a six (6) foot wide unobstructed pedestrian access route may be allowed if approved by the Planning and Development Services Director, or designee. Wider sidewalk and pedestrian circulation route widths should be provided in locations where significant pedestrian traffic is anticipated, and where wider pedestrian access routes exist.
 - f. The primary pedestrian circulation route in front of the storefronts of major retail centers and mixed-use buildings shall be connected to adjacent streets that have sidewalks or multi-use trails adjacent to them, and to parking with a primary pedestrian circulation route that complies with section 2-1.514. A.1.d.
 - g. Width. Except as indicated above for retail centers and mixed-use buildings, the primary pedestrian circulation route shall be a minimum six (6) feet wide continuous unobstructed primary pedestrian sidewalk, excluding any parking overhangs or other obstructions, throughout a development. In locations where a sidewalk width of six feet cannot be provided due to existing physical barriers or other constraints, then a five (5) foot wide clear and continuous sidewalk may be allowed if approved by the Planning and Development Director, or designee. Provide wider width adjacent to retail centers and mixed-use building storefronts.

- h. Accessibility. In accordance with Chapter 12 of the DSPM, the primary pedestrian circulation route shall be accessible when required.
 3. Secondary Pedestrian Circulation Route.
 - a. Secondary Pedestrian Circulation Routes generally are pedestrian sidewalks to a building entry, other than the main building pedestrian entry.
 - b. Non-residential development. Secondary pedestrian circulation routes connect secondary building entries to the primary pedestrian circulation route, to another the secondary building entry of a different building, and from a build's secondary building entry to a parking lot.
 - c. Multi-family development. Secondary pedestrian circulation routes connect the residential buildings to the primary pedestrian circulation route, and a residential building's secondary entry to the adjacent street.
 - d. Width. The secondary pedestrian circulation route should have a minimum continuous unobstructed width of four (4) feet; a forty-two (42) inch wide unobstructed pedestrian access route may be allowed if approved by the Planning and Development Services Director.
 - e. Accessibility. In accordance with Chapter 12 of the DSPM, the secondary pedestrian circulation routes shall be accessible when required.
 4. Incidental Pedestrian Circulation Route.
 5. Incidental Pedestrian Circulation Routes are generally pedestrian sidewalks that are not general accessed by pedestrians on a regular basis.
 - a. Incidental pedestrian circulation routes connects: secondary building entries to secondary operational buildings; service yards; storage areas; refuse or recycling enclosures; utility locations; alleys; and other back-of-house operations such as delivery doors.
 - b. Width. The incidental pedestrian circulation route shall have a minimum continuous unobstructed width of three (3) feet.
- B. Provide shade for primary pedestrian circulation route wherever possible either through the use of tree canopies or structural canopies. Secondary pedestrian circulation routes are to be shaded wherever possible. Canopy supports, mature tree trunks and outdoor dining should not encroach into the minimum width of the pedestrian circulation route. It is important to anticipate the mature size of tree trunks that are adjacent to sidewalks, in an attempt to prevent trees from reducing the sidewalk width and uplifting hardscape surfaces.
- C. Design the primary pedestrian connection route as an accessible rout in accordance with Chapter 12 of the DSPM. Were feasible, all pedestrian circulation routes should be accessible. Exceptions shall comply with Chapter 12 of the DSPM.
- D. On-site pedestrian circulation routes provided within an easement dedicated to the city shall comply with the Primary Pedestrian Circulation Route requirements and Chapter 12 of the DSPM.

DRAINAGE FACILITIES

- A. Land adjacent to walkways or curbs shall be graded so that it falls away from the walk or curb at a slope of at least 8 percent but not more than 25 percent for a distance of at least 10 feet to provide positive drainage away the sidewalk or curb.

2-1.400

- B. Refer to Chapter 4 of the DSPM for additional Grading and Drainage requirements.

DETENTION BASINS

2-1.401

Incorporate the following criteria in the design of drainage detention basins:

- A. No more than 50 percent of the total front open space (as defined by the Zoning Ordinance) and frontage landscape area may be utilized as a retention area unless specifically approved by the DRB.
- B. The maximum depth of water stored in the basin should be 3 feet, see Figure 2-1.9, below.
- C. The maximum side slope of the basin is 4:1 (run-to-rise) unless otherwise approved by city staff. Walled banks may be permitted subject to the separate wall design approved by the DRB.
- D. The maximum ratio between the width-to-depth of a retention basin shall be ten-to-one (10:1, run-to-rise), unless otherwise approved by the Planning and Development Services General Manager's designee.
- E. Round and contour the bottom and top edges of the side slopes to achieve a gradual slope transition.
- F. Use textured and/or dark surface treatments on the portion of the wall that could be inundated to minimize the visibility of staining typical to basins where retaining walls are used as an edge of a basin. Place safety railings or solid walls at least 42 inches tall on top of such walls where a grade change is vertical and 24 inches or greater, or a slope greater than a 3:1 (run to rise). The height of the railing or wall is measured from adjacent grade, or surface of the adjacent sidewalk.
- G. Use only plant materials in basins that are capable of being inundated and surviving. Trees and woody shrubs are preferred; avoid succulents and herbaceous shrubs in basins. In areas where natural desert plants are being used, use plants that are typical to desert riparian areas, such as mesquite, blue palo verde, desert willow, wolfberry, desert hackberry, desert holly, jojoba and beloperone, etc.
- H. Do not place drainage basins on individual lots unless the following criteria are met:
 1. The basin is directly accessible and visible from a street or alley.
 2. The maintenance of the basin is designated to a property owners' association.
 3. The basin and its access are placed within a drainage and access easement.

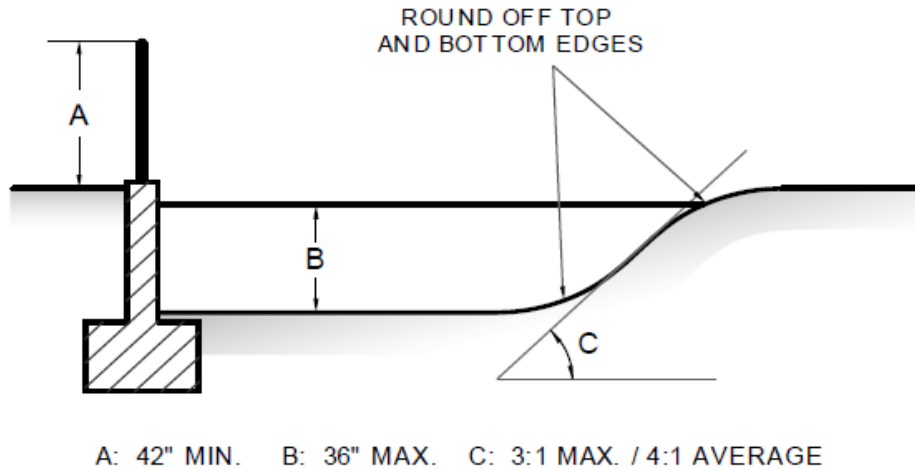

FIGURE 2-1.9 DETENTION BASINS

- I. Natural growth habits shall be taken into consideration to minimize maintenance frequency and intensity.
- J. Landscaping should not create hazards to public safety through plant growth habit, structure, or location.
- K. Trees should not be planted within 10 feet of an existing private wall, sign, light pole, or fire hydrant.

SURFACE CHANNELS

2-1.402

Site plans should incorporate the following criteria in the placement, design and use of surface drainage facilities:

- A. Keep major natural vegetation specimens along washes in place wherever possible.
- B. Place amenities for the on-site use, such as dining patios or recreation centers, next to drainage ways where feasible.
- C. Landscape any engineered and constructed channels in a manner that helps to manage the storm flows and provides the channel as a visual amenity for the site and community. Concrete and rock surfaces should be kept to a minimum. If such materials are used, they should be formed and applied in a "natural" manner or designed to integrate with the onsite buildings.
- D. Provide walkways and/or trails on large sites of 20 acres or more next to or where appropriate within such drainage ways.
- E. Any rock used in any drainage facility shall be native and/or crushed rock. Do not use river rock.

NATIVE PLANTS IN DETENTION BASINS & DRAINAGE CHANNELS

2-1.403

The following is a guide in the use of native plants within detention basins and improved drainage channels:

- A. **Plants that can be placed on the bottom of a basin:**
 - o Velvet Mesquite (*Prosopis velutina*)
 - o Four-wing Saltbush (*Atriplex canescens*)
 - o Desert Hackberry (*Celtis pallida*)

- Catclaw (*Acacia greggii*)*
 - Scrub Oak (*Quercus turbinella*)*
 - Chuparosa (*Justicia californica*)
 - Canyon Ragweed (*Ambrosia ambrosioides*)
- B. Plants that may be placed on the sides of a basin:**
- (All plants listed above)
 - Ironwood (*Olneya tesota*)
 - Blue Palo Verde (*Cercidium floridum*)
 - Desert Willow (*Chilopsis linearis*)
 - Saguaro (*Carnegiea gigantea*)
 - Wolfberry (*Lycium Sp.*)
 - Desert Lavender (*Hyptis emoryi*)
 - Fairy Duster (*Calliandra eriophylla*)
 - Creosote (*Larrea tridentata*)
 - Jojoba (*Simmondsia chinensis*)*
 - Hopbush (*Dodonaea viscosa*)*
 - Mormon Tea (*Ephedra trifurca*)*
 - Cheese Bush (*Hymenoclea monogyra*)
 - Deer-Vetch (*Lotus rigida*)*
 - Sugar Sumac (*Rhus ovata*)*
- C. Plants that should not be used in any part of a basin:**
- Foothills Palo Verde (*Cercidium microphylla*)
 - Chollas and Pricklypears (*Opuntia Sp.*)
 - Barrel Cacti (*Ferocactus Sp.*)
 - Bursage (*Ambrosia deltoidea*)
 - Century plants (*Agave Sp.*)
 - Brittlebush (*Encelia farinosa*)
 - Buckwheat (*Eriogonum fasciculatum*)
 - Ocotillo (*Fouquieria splendens*)

(*) - Plants that should be installed in locations above 1800 feet in elevation.

LANDSCAPE DESIGN

2-1.500

DESIGN STANDARDS

2-1.501

- A. Provide landscaping in accordance with Article X of the Zoning Ordinance, and city's Water Conservation Ordinance (Chapter 49; Article VII).
- B. Utilize a palette of plants in a landscape design that adhere to the Arizona Department of Water Resources (ADWR) Low Water Use/Drought Tolerant plant list. The DRB may approve alternative plant material
- C. Plants and trees which are not protected by the SRC native plant provisions, but which are necessary for on-site revegetation, are suitable for transplanting, or are necessarily uprooted for road building or similar construction, as determined by city staff, shall be stockpiled during construction and shall be replanted in on-site landscape areas by the developer before the final site inspection. Plant and tree placement shall consider the natural culture of that type of plant or tree.

- D. The maximum height of any shrubs, ornamental plants, boulders, walls or other such materials within designated sight distances and traffic safety triangles is 18 inches. For plants, this shall be the natural height of the plant. Any trees that are to be placed in the sight distances and traffic safety triangles shall have a canopy that is kept 8 feet above the curb height and a maximum mature trunk diameter of 8 inches. If the tree canopy overhangs the roadway, then the canopy shall be a minimum of 13.5 feet above the road, see Figure 2-1.10. See the landscaping requirements for intersection sight distances and traffic safety triangles in Section 5-3.119, especially Figure 5-3.25 and Figure 5-3.26.
- E. Do not place trees and boulders within a Public Utility Easement (PUE), Emergency Vehicle Access Easement or their equivalent.
- F. Place trees and saguaros at least 7 feet back from any underground public water or sewer lines, power line conduit, or drainage pipes within a dedicate drainage easement dedicated to the City. Refer to Figure 2-1.11.
- G. The following plants shall not be used in any landscaping installation or revegetation program:
- Desert Broom (*Baccharis sarothroides*)
 - Red Bromegrass (*Bromus rubens*)
 - Buffel Grass (*Pennisetum ciliare*)
 - Salt Cedar (*Tamarix* species (spp.))
 - Fountain Grass (*Pennisetum setaceum*)
 - Mexican Palo Verde (*Parkinsonia aculeata*)

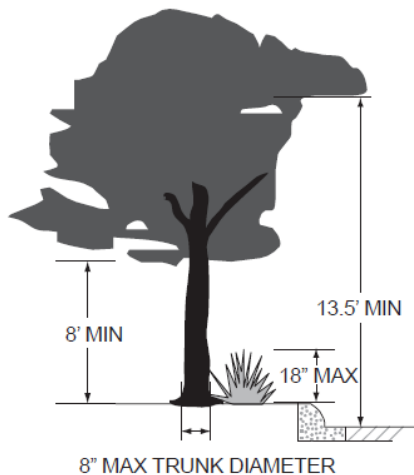

FIGURE 2-1.10 LANDSCAPING IN THE SIGHT VISIBILITY TRIANGLE

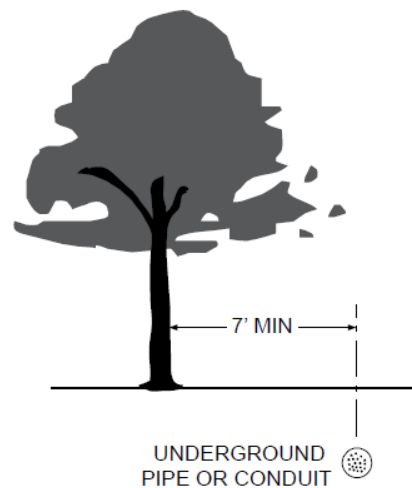

FIGURE 2-1.11 TREE SETBACK FROM UNDERGROUND PIPE OR CONDUIT

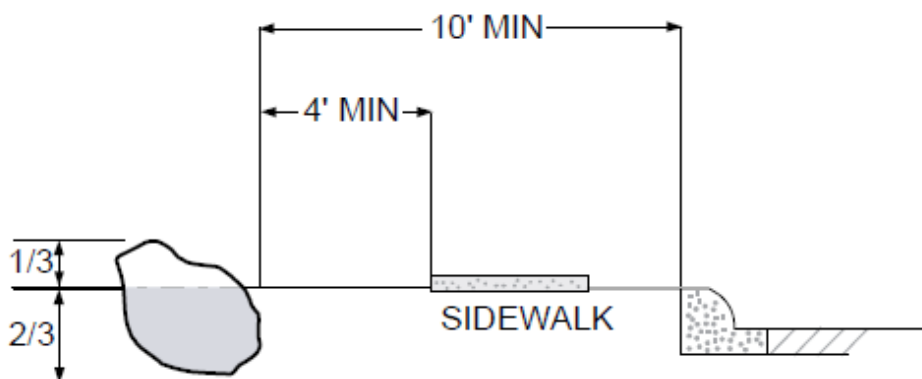

FIGURE 2-1.12 BOULDER PLACEMENTS

- H. Install boulders with 2/3 of their volume below the ground and place them at least 10 feet away from any curb and at least 4 feet from any walkway, see Figure 2-1.12, above. (Boulders shall not be installed in medians or rights-of-way that will be maintained by the city unless separate approval from the city's Risk Management Division and Parks Department).
- I. Install decomposed granite, if used as a ground cover, to a minimum depth of 2 inches on sites outside of ESL areas.
- J. Use shall be native and/or crushed rock for any rip rap applications. Do not use river rock.
- K. Place trees so that their mature canopies do not overhang vehicular lanes of a street, cross property lines, or block monument or tower signs.
- L. Do not plant thorny shrubs and cacti where their mature canopy would be closer than 4 feet from any walkways or parking area curbing.
- M. Do not plant shrubs and trees within the 2 feet overhang at the head of a parking stall.
- N. Provide base planting landscaping areas adjacent to the building on all sides of buildings in a suburban or rural type of context, except where there are designated

loading areas. Unless otherwise approved by the DRB, the minimum width of any such area shall be 4 feet excluding any pedestrian walkways. Include trees and shrubs in these areas that provide strategic shading of the windows and doors, reinforce the architectural elements of the building, and provide comfort and interest to pedestrians.

- O. City maintained landscape installation shall conform to the most current city supplement to MAG Section 430 and related details.
 - 1. Consider the natural growth habits of plants when design a landscape plan to minimize maintenance frequency and intensity.
 - 2. Place landscape plant material to prevent creating a public safety hazard through plant growth habit, structure, or location.
- P. City maintained trees should not be planted within 10 feet of an existing sign or light pole.

IRRIGATION

2-1.502

- A. Provide irrigation to all landscaped areas in accordance with the Zoning Ordinance.
- B. Completely screen backflow preventers using a screening wall, cage or dense plant materials. Place them next to the water meter in accordance with Water Resources Department requirements.
- C. Connect irrigation systems to a back flow preventer that is to be provided in accordance COS MAG details.
- D. Do not connect water features to the irrigation system. Connect water features to a dedicated line either from the meter or from a building. Provide a backflow preventer between the building and/or meter in accordance COS MAG details.
- E. Use the COS MAG details and specification for all irrigation systems to be maintained by the City.

SUBDIVISION & NEIGHBORHOOD DESIGN

2-1.600

This section focuses on standards and approaches that achieve good subdivision design in the context of Scottsdale and its settings and neighborhoods. It applies to all major and minor subdivisions as well as any other form of land division. These criteria are preferred approaches, but alternative approaches that achieve equivalent protection of existing neighborhoods and the native desert setting may be proposed and accepted.

At the request of city staff and before the DRB application, the developer shall stake the alignments for all internal streets and driveways subject to inspection by Planning and Development Services Department’s staff to confirm that the proposed alignments result in the least environmental and hydrological impact. The Planning and Development Services project coordinator may approve the use of rectified aerial photographs in-lieu of on-site staking.

STREET DESIGN

2-1.601

Design the location and arrangement of streets to conform to the following general principles:

- A. Whenever a proposed subdivision embraces any part of a street shown on a street plan adopted by the city, the subdivision shall be platted in conformance with the adopted street plan.
- B. Street layout shall provide for the continuation of streets shown on any adopted street plan as the city may designate.
- C. The city may require the owner to extend certain proposed streets to the boundary of the proposed subdivision to provide future connections with adjoining land.
- D. Local streets shall be arranged to discourage their use by through traffic.
- E. Where a proposed subdivision abuts or contains an existing or proposed arterial street, the city staff may require frontage streets or reverse frontage with vehicular non-access easements (V.N.E.) along the arterial street, or other treatment to protect residential properties from the nuisance and hazard of high volume traffic, and to preserve the traffic function of the arterial street.
- F. Where a subdivision abuts or contains the right-of-way of a limited-access highway or an irrigation canal, or abuts a commercial or industrial land use, the city may recommend location of a street approximately parallel to and on each side of such right-of-way at a distance suitable for appropriate use of the intervening land. Such distance shall be determined with due regard for approach grades, drainage, bridges or future grade separations.
- G. Within a subdivision, provide streets with complete right-of-way dedications or private street tract widths and improvements that comply with the Chapter 5. On the perimeter of a subdivision, provide right-of-way dedications to complete the street patterns in accordance with Chapter 5. In limited situations, the Transpiration Director or designee may allow half-streets right-of-way dedications and improvements to complete a street pattern, or to ensure reasonable development of adjoining parcels are provide access. Where a platted half-street abuts a proposed subdivision and the half-street furnishes the sole access to residential lots, the remaining half shall be platted within the street.
- H. Where there are existing streets adjacent to the subdivision, subdivision streets shall, at a minimum, be improved to the intercepting paving line of such existing streets.
- I. All streets (including private streets) shall be designed and constructed in conformance with the DSPM.
- J. Alleys shall be designed and constructed in conformance with the following right-of-way width standards:
 - 1. Sixteen feet if single-family residential on both sides;
 - 2. Twenty feet if abutting commercial, multiple-family residential or industrial districts.
- K. Alley intersections and sharp changes in alignment shall be avoided, but where necessary corners shall be cut off 15 feet on each side to permit safe vehicular movement. Dead-end alleys are prohibited.
- L. Dead-end streets serving more than 4 lots shall be graded and surfaced to provide a turning circle to conform to standards in the DSPM.

BLOCK DESIGN

2-1.602

- A. Where a new subdivision is being placed in an infill location, the block size, dimensions and orientation should generally match those of the surrounding area. If in some cases it is advisable to terminate any existing street connection, it may be necessary to continue a pedestrian walkway across the block to maintain current pedestrian accessibility.
- B. In general, block lengths should be kept to a maximum length of 800 feet. Block lengths greater lengths are strongly discouraged.
- C. Where block lengths exceed 660 feet, pedestrian connections through a block from on street to another may be required. This is most important if there is a nearby school, park, recreational amenity or similar destination. These connections shall be placed within a tract that has a minimum width of 20 feet for single use paths or trail, and 30 feet for multiple use corridors and where the terrain is difficult.
- D. Do not create corner lots that abut key lots.
- E. In ESL areas these criteria may be waived where there are major terrain constraints and large natural areas that are being preserved.
- F. Street and lot designs shall be arranged so that they work with the constraints of the natural topography to achieve desirable lots with viable building envelopes, streets with reasonable gradients, and adequate, manageable drainage facilities.

PERIMETERS OF DEVELOPMENT

2-1.603

A. Along Major Streets

The following criteria apply to perimeters that front streets classified as collectors, arterials or parkways:

1. Residential lots shall not be placed with such streets as their sole point of access. A one (1) foot wide V.N.E. shall be placed along such frontages. An exception may be considered where the lot sizes are equal to or greater than 35,000 square feet. In such cases, lots may be allowed to access a local or minor collector, if they are required to provide shared driveways, circular driveways, or a similar driveway configuration that does not lead to a vehicle backing on to the street.
2. Wherever possible lots should not be oriented with rear yards facing the major street. The following techniques should be considered:
 - a. Place lots so that their side yards abut the street. Cul-de-sac turn-arounds should extend to the right-of-way of the major street.
 - b. Place the front yards toward the major street, using a frontage road approach for access to the lots.
3. Landscaped buffers are common along the perimeter of subdivisions where they front on to major streets. To assure there is adequate room for meaningful landscaping in such situations, the width of the landscape tract along the major street frontage should be as follows:
 - a. Major Arterial Street Frontage: 15 feet wide tract
 - b. Minor Arterial Street Frontage: 15 feet wide tract
 - c. Major Collector Street Frontage: 15 feet wide tract

- d. Minor Collector Street Frontage: 15 feet wide tract
 - e. Residential Street Frontage: 10 feet wide tract
 - f. Commercial Street Frontage: 15 feet wide tract
4. Where single family residential lots in a subdivision have double frontage with one of the fronts facing an arterial or collector street, a V.N.E. and a tract equal in width to the landscaped buffer described above shall be provided.

B. Along Non-Residential Uses

1. Where a residential subdivision abuts a non-residential use, the following lot layout techniques should be considered:
 - a. Provide a landscaped or open space buffer of at least 25 feet in width and place the lots so they 'side' on to this buffer.
 - b. Place the fronts of the lots toward the non-residential use, using a local street as a physical separation.
 - c. Any combination of techniques that avoid having active rear yard areas and bedroom areas in the residences exposed to the adjacent use.
 - d. If there is a substantial open space separation (at least 100 feet in width) it may be acceptable to have rear yard areas directed toward the non-residential use.
 - e. Wherever possible, functions such as detention basins, recreational facilities, common storage areas, and other such uses should be used to provide buffering from adjacent non-residential uses.

C. Along Existing Residential Uses

1. To the greatest extent possible the lots in a new subdivision should mirror the layout of an existing adjacent subdivision (rear yards adjacent to rear yards, side yards adjacent to side yards, etc.).
2. Where feasible, lot dimensions and setbacks in a new subdivision should match those of the adjacent existing subdivision for those lots that abut the adjacent subdivision, particularly if there is little or no separation between the lots of the two subdivisions.
3. Grade changes from the off-site grades along the perimeter of a new subdivision should be minimized. The lots in the new subdivision should not be more than 18 inches above the abutting lots in the existing subdivision. If greater grade change is desired, there should be a buffer or a gradual grade transition on the new subdivision to minimize the change at the property line.

D. Along Vacant Properties

Grade breaks at the edge of a subdivision should be kept to less than 2 feet wherever possible. If this is not possible then these lots should be made deeper so that the transition is not so abrupt.

SUBDIVISION ENTRIES

A. Entry Street Design

1. Entry streets into a subdivision should not terminate into a "T" intersection with lots facing down the entry street. This termination should end at an open space, a recreational facility, or into a cul-de-sac.
2. Where an entry street for a subdivision is relatively short (less than 600 feet), there should not be any lots directly accessing the entry street.

2-1.604

B. Connections

1. To minimize congestion at entries into a subdivision as well as the street that the subdivision is accessed off, there should be an entry street for every 75-100 homes in the subdivision. It is understood that this may not be feasible in ESL areas due to the terrain.
2. Wherever possible, entry streets for a subdivision should align with streets on the other side of the road that they intersect with.
3. Where a subdivision is adjacent to vacant lots, un-subdivided lots or a street from an adjacent subdivision, the new subdivision should provide equal rights-of-way to complete the street or should extend street rights-of-way to the adjacent parcels unless it can be proven that another viable access route is available to them.
4. Pedestrian connections to adjacent properties or streets should be provided where there are nearby schools, parks or other such pedestrian destinations.

C. Gated Streets

1. Gated streets should only be used where there are sufficient lots available to support future maintenance and reconstruction of the street. In general, avoid gated subdivisions of less than 20 lots.
2. All subdivision or neighborhoods that have private streets shall be accessed through a controlled access gate.

LOT DESIGN

- A. Since corner lots have two frontages they are more limited than other lots in providing usable private outdoor space. To compensate for this, it is recommended that corner lots be wider than the other typical lots in the subdivision, as follows:
 1. Lot sizes of 4,500 – 6,500 sq. ft.: 5 feet wider
 2. Lot sizes of 6,600 – 12,000 sq. ft.: 7 feet wider
 3. Lot sizes of 12,000 – 24,000 sq. ft.: 10 feet wider
 4. Lot sizes of 25,000 – 45,000 sq. ft.: 15 feet wider
- B. Do not create corner lots that abut key lots.
- C. Through or double frontage lots are discouraged. If lots are to be laid out with rear yards facing a street, it is recommended that landscape tracts be established along the street with widths as recommended in Section 2-1.1003 paragraph A.3.
- D. If unusual (multi-sided, non-rectangular, etc.) lot designs are proposed, the PP, and a setback exhibit submitted with the final plat. shall indicate the locations of all setbacks and yards on the lot, subject to the approval of Zoning Administrator.
- E. Design lots so that the buildable portion of a lot is accessed without having to cross a wash or drainage way. In the unique situation where the building area of the lot cannot be designed to be accessed without crossing a wash or drainage way, the DRB may approve a lot design that allows the buildable area of the lot to be accessed by crossing the wash or drainage way. When allowed, the developer of the lot(s) shall construct the wash or drainage way crossing to access the buildable area of the lot with the infrastructure improvements.
- F. Unless there is no other reasonable solution, the access to the buildable portion of a lot should not cross a wash or drainage way.

2-1.605

- G. All residential lots shall have frontage on and access to a public street or private street in conformance with city code. All non-residential lots shall have frontage on and/or access to a public street or private street in conformance with city code.
- H. Common driveways serving two adjacent lots may be advisable where the access to the lots crosses a minor or major wash, there are significant rock formations and boulders, or there are slopes greater than 10%. The route of the common driveway shall be included in an access easement shown on the plat. If this driveway crosses a wash, the driveway should be improved beyond the crossing at the time the master subdivision improvements (streets, infrastructure, etc.) are improved.
- I. Flag lots should not be used regularly in the layout of subdivisions. However, where there are major washes, rock formations or steeper slopes that would cause a street extension to achieve frontage to each lot to result in significant cuts and fills, flag lots can be used to reduce the physical impact of providing access and utilities to lots in sensitive areas.
- J. All residential subdivisions in the ESL area shall establish a construction envelope at the time of Preliminary Plat approval.

Section 2-2

ENVIRONMENTALLY SENSITIVE LANDS

2-2

This section specifies site design considerations, standards, and criteria for the area covered by the ESL zoning district. It addresses utility location, grading and drainage issues, roadway improvements and site work guidelines for protecting the unique topography, vegetation and geology within the ESL area.

GENERAL INFORMATION

2-2.000

A. History/Background

The ESL zoning district is a set of zoning regulations that was adopted by the City Council to guide development throughout the 134 square miles of desert and mountain areas of northern Scottsdale. In addition to being governed by different versions of the ESL zoning district, some projects and subdivisions are governed by the Hillside Ordinance that was established in 1977. These areas are generally located north and east of the Central Arizona Project canal. Refer to Figure 2-2.1. To verify that a parcel is located within the Environmentally Sensitive Lands area, and to confirm the landform category, refer to the [Digital Map Center](#).

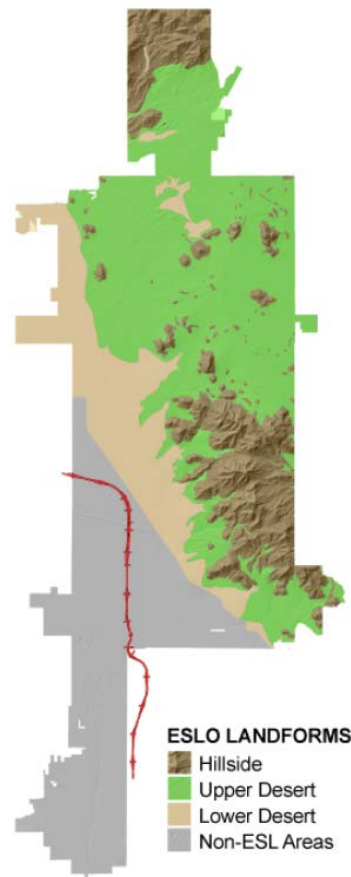

FIGURE 2-2.1 ESL AREA / LANDFORMS MAP

B. Purpose

The intent and purpose of ESL zoning district is to identify and protect environmentally sensitive lands in the city and to promote public health and safety by controlling development on these lands. The ESL zoning district requires that a percentage of each property be permanently preserved as Natural Area Open Space (NAOS) and that specific environmental features must be protected, including vegetation, desert washes, mountain ridges and peaks, to assure appropriate development. For specific ordinance text concerning the ESL zoning district, refer to the [Zoning Ordinance](#), Section 6.1010.

C. Goals

The ESL zoning district was established to:

1. Protect the public and property from the special hazards that can be found in this desert setting.
2. Encourage the protection of unique and sensitive natural features in the Upper Sonoran Desert, including but not limited to, mountains and hills, large rock formations, native landscape, archeological and historical sites, and significant desert washes.
3. Minimize the costs to build and maintain the public infrastructure that is needed to sustain the use of the land.
4. Encourage development that blends with the character and nature of this special desert setting. This ordinance is not intended to deny the reasonable use of land, but to guide its use in ways that are sustainable and recognize the unique opportunities that this setting provides.

D. Community Benefit

The ESL zoning district has a direct impact on the residents of Scottsdale by determining the location and design of residential, commercial, industrial, and institutional development in approximately two-thirds of the city. Application of the ESL zoning district, and its predecessor the Hillside District (HD), has resulted in the preservation of over 9,000 acres of Sonoran Desert open space, while protecting residents from potential flooding, erosion, and detrimental visual impacts.

E. Major Environmental Features and Resources

The regulations and standards of the ESL zoning district are based upon major natural features such as landforms, protected ridges and peaks, and significant desert washes. To provide a uniform basis for determining the location of these features, the city has prepared [maps](#) of these features.

In addition, there are [maps](#) that highlight the priority locations for the placement of NAOS on properties that are based upon significant environmental features of the land, as well as the intent to maintain the continuity of these natural open spaces.

F. Determination of Appropriate Version of the Ordinance for Application on a Property

The ESL zoning district was originally approved and applied in 1991. Subsequently, there were major updates to this ordinance in 2001, 2003, and 2004. The applicable version of the ESL zoning district is the one that was in effect at the time that development approvals were established for the property or the initial building permits were issued. In addition, some developments were originally approved under the HD zoning district and continue to be governed by the rules and procedures of that HD zoning district (originally approved in 1977 and amended in 1982). The amendments to the ESL zoning district are minor and apply to all properties that are subject to the ESL zoning district regulations. For determination of which ordinance, as well as which version, applies to a given property, contact the One Stop Shop or Current Planning staff in the One Civic Center building at 7447 E. Indian School Road.

UTILITIES

2-2.100

In general, locate and design utility facilities and corridors to minimize degradation of key natural desert features that are being conserved by the ESL zoning district. This section provides guidelines that support the goals of the ESL zoning district while also allowing for the reasonable and necessary installation of infrastructure that will be serving the land uses that are in the area. Refer to Chapter 6 and 7 of this manual for specific guidelines related to water distribution and wastewater collection lines. Use the following general principles in the design and construction of utility facilities in ESL areas:

- A. Install utility corridors that do not result in slope movement or surface subsidence.
- B. Prevent increased erosion along utility corridors.
- C. Avoid utility crossings that obstruct or constrict desert washes.
- D. Replace vegetation that has been removed, for utility construction or maintenance, with appropriate native desert plants.
- E. Avoid placing utility corridors that will require frequent maintenance through significant riparian, vista, or habitat corridors.
- F. Place all utility facilities underground or screen them from public view.

WATER DISTRIBUTION LINES

2-2.101

A. Location

To minimize their impact in ESL areas, locate all public water distribution lines within private and public street rights-of-way. Location of water system lines in other areas will require approval from the Water Resources Department. Water lines that must be located outside of public rights-of-way must be located within either a waterline easement or within a tract, where applicable.

Place water lines within the paved street section rights-of-way and locate water meters adjacent to driveways to reduce the impact to sensitive ESL area landforms.

B. Easements

The minimum width of easements within tracts is 20 feet. Place the entire easement on one side of a property line.

Any vertical barrier that crosses an easement must be constructed of wood, wire, or removable type of fencing. Revegetation or landscape improvements that are within the easement must not restrict access to the utility that is located within the easement. Refer to Chapters 3 and 6 of this manual.

C. Crossings of Storm Water Drainage Ways

Water lines should not cross storm water drainage ways unless the crossing is associated with a roadway or driveway. If a crossing is required, then locate the water line as near to perpendicular to the flow path of the storm water drainage way as possible.

D. Water Storage Facilities

Locate water storage facilities, such as water tanks and reservoirs, underground and/or in such a way that it will reduce the impact to the surrounding environment.

Paint any above grade tank surface to match surrounding native stone, rock, or soil color.

Tanks are prohibited on slopes that are greater than 3:1 (horizontal to vertical), unless approved by the Planning and Development Department Director and Water Resources Department Director, or their respective designees.

SEWER DISTRIBUTION LINES

2-2.102

A. Location

To minimize their impact in ESL areas, locate all public sewer collection lines, including public sewer force mains, within private and public street rights-of-way. Wastewater lines that must be located outside of public rights-of-way must be located within either a sewer line easement or within a tract.

Sewer lines can cross the centerline, and be located within the paved street section, but should not cross the curb line. Locate manholes to keep manhole covers out of the tire paths on the roadway.

B. Easements

The minimum width of easements is 20 feet. Place the entire easement on one side of a property line.

Any vertical barrier that crosses an easement must be constructed of wood, wire, or removable type fencing. Revegetation or landscape improvements that are within the easement must not restrict access to the utility that is located within the easement.

C. Drainage Ways

Do not locate wastewater lines within any storm water drainage way that may be inundated by a 100-year storm flow, unless specifically approved by Planning and Development Department Director and Water Resources Department Director, or their respective designees. Exceptions will be based upon specific design analyses that demonstrate that there will be no mixing of wastewater and stormwater flows, and that no other viable solution is available. If a wastewater line must be located alongside a storm water drainage way, then do not clear existing natural riparian vegetation during construction of the wastewater line.

Do not cross storm water drainage ways with wastewater lines unless there is no other reasonable alternative alignment. Where possible, place such crossings in association with the location of roadways or driveways, and/or perpendicular to the flow path of the storm water drainage way.

PUBLIC LIFT STATIONS

2-2.103

In ESL areas, wastewater pumping stations and pressurized collection systems may be used with Water Resources Department approval.

Protect wastewater pumping stations from inundation by stormwater runoff. Locate such stations so that adequate access is available. Contact the Water Resources Department prior to design of wastewater systems in ESL areas.

INDIVIDUAL SEWAGE EJECTOR SYSTEMS

2-2.104

If sewer service cannot be provided by gravity flow, then install an individual sewage ejector pump to transport wastewater from a residence. The private ejector pump

shall meet all State and County Health Department, and Local Building Code requirements.

The property owner shall maintain the private ejector pump. Each ejector pump shall serve only one lot and may not extend past the property line, unless otherwise approved by the Water Resources Department. Septic system facilities, including leach fields, shall not be located within designated NAOS easements. Refer to Chapter 7 of this manual.

ON-SITE WASTEWATER TREATMENT

2-2.105

In ESL areas where connection to a public sanitary sewer (SS) collector is not available, an individual sewage disposal system may be approved. On-site wastewater disposal systems are subject to authorization by the Water Resources Department prior to approval from the Maricopa County Department of Environmental Services. Locate such facilities per Maricopa County requirements. Any areas that have been cleared for such facilities must be revegetated to a native desert landscape.

MISCELLANEOUS UTILITIES

2-2.106

A. Location

Locate utility lines within private streets and public rights-of-way to minimize the impact on ESL areas. The paved street section is reserved for water and sewer lines, enabling other utilities to be placed within the balance of the rights-of-way. Utility locations in the ESL areas will be restricted due to grading limitations.

If circumstances dictate that utility lines will need to be placed outside of public/private rights-of-way, then establish a PUE or tract.

Construction of underground utilities may adversely impact adjacent lands.

Therefore, revegetation of all disturbed areas will be required after installation, or any subsequent maintenance activities.

Avoid locating utility lines in storm water drainage ways and channels. If such locations are necessary, then the construction plans shall specify how to protect the facility from storm water runoff flows.

B. Design of Utility Cabinets

Any utility cabinets that are located within ESL areas shall be painted Frazee Paint 'Enduring Bronze (SW 7055) or shall be constructed of self-weathering steel. Any land surrounding a utility cabinet that has been disturbed by the installation of the cabinets and related utilities, shall be restored to a natural desert condition with native plant materials.

Utility cabinets shall be screened in one of the following ways:

1. Placed in vaults below the ground level;
2. Enclosed within a self-weathering steel enclosure fence that incorporates a three-dimensional design;
3. Enclosed within a wall that incorporates native stonework, rammed earth, or exposed aggregate and colored concrete;
4. Berms landscaped with native desert plants and shaped to blend into the natural terrain; or
5. Dense landscaping with desert trees and large shrubs.

C. Easements

Do not place PUEs along the edge of rights-of-way unless they are required by the specific design for installing utilities in that location. Keep the installation of utilities within the rights-of-way.

Utility easements along any side or rear lot line must be entirely within a lot (so that the easement is not split with part on 1 lot and the remaining portion on an adjacent lot) and must be at least twelve (12) feet wide. Utility easements along the front of lots and tracts must be at least eight (8) feet wide.

STORMWATER DRAINAGE PLANNING

2-2.200

The analysis of hydrologic and hydraulic hazards within this region must consider impacts to all downstream areas. Failure to consider these impacts may result in hazardous diversions of storm water flow, increases in peak discharge flow rates, and disruption of the transport equilibrium. Any of these phenomena could increase the flooding and erosion potential to downstream properties and create a liability.

Therefore:

- A. Design drainage facilities to maintain the natural runoff and channel characteristics.
- B. Do not adversely impact storm water drainage patterns, including the location and configuration of watershed boundaries.
- C. Maintain the stability of existing storm water drainage channels and desert washes, particularly the channel banks, as much as is possible.
- D. Do not increase the natural volume of existing channel flows.
- E. Maintain the natural sedimentation characteristics of an existing drainage way.
- F. Do not restrict or obstruct the natural habitat condition or desert fauna movement with improvements to existing channels.
- G. Maintain the natural vegetation density and diversity of existing channels.
- H. Preserve the view-shed characteristics of large desert washes and vista corridors.
- I. Design detention basins so that they blend into the natural contours and undulations of the site and the local natural terrain.
- J. Locate detention basins within a subdivision in separate tracts, not on individual lots. Exceptions may be made by the Zoning Administrator, or designee, if the following conditions are met:
 1. The basins will be maintained by a property owners' association, or its equivalent;
 2. Appropriately sized drainage and maintenance access easements are provided; and
 3. The basin is accessible from a street.

Refer to Chapter 4 of this manual.

IMPROVEMENTS TO NATURAL WASHES

2-2.201

Design any improvements to natural desert washes so that they complement the natural function and appearance of the site. It is preferable to leave the washes in an undisturbed state and use sufficient building setbacks to preclude the need for artificial bank protection.

Avoid any disruption of the natural geometry and bed-profile of desert washes in the ESL areas to the greatest extent feasible. This includes any unnatural diversion of water into or from these washes. Such diversion could upset the system equilibrium and induce accelerated bank erosion and long-term degradation of the channel bed.

A. Incised Natural Desert Washes

Virtually all desert washes in the Hillside landform, and many of the washes in the Upper Desert landform, are deeply incised. As such, they generally have capacity that is equal to or exceeding that necessary to contain the anticipated storm flows. The steep slopes in the Hillside landform and the relatively steep slopes in the Upper Desert landform promote very high velocity flows. This creates a potential for bank erosion and bed scour. Due to bedrock outcrops and relatively large diameter sediment particles that are found in these desert washes, bed scour may be arrested by channel armoring, particularly in association with road crossings. This phenomenon will be evaluated on a case-by-case basis.

Avoid the use of structures that might form an artificial grade control. Consider clear span bridges for crossings where multiple barrel culverts may impede the flow due to the amount of sediment transport or debris that is likely to occur during a major storm event.

Include the entire top-of-bank to top-of-bank dimension that exists naturally, in addition to the area normally required to contain the 100-year storm, within drainage easements along incised washes.

B. Over-bank Flow and Braided Washed

In portions of the Upper Desert landform and across most of the Lower Desert landform, washes do not have natural channels with adequate capacity to contain major storm water flows. In major storms, flows will fill the visible channel, inundate adjacent lands, then divert into other braided channel courses and/or become sheet flow that is not confined to any drainage way. Modifying or restructuring the natural drainage way may be needed to protect structures and public infrastructure. To maintain control of flood flows along such drainage ways, provide reinforced channel banks by using reinforced embankments, flood walls, raised pads for buildings, or other such methods.

Reconstructing or relocating a natural channel may be considered only when it has been demonstrated that there is no other reasonable approach available.

Relocated desert wash channels shall be designed and constructed in a manner that restores the wash to a natural condition, with revegetation of native desert plants that are typical to local washes, and with contours that blend into the natural topography. Placing channels into underground drain pipes shall not be utilized unless there is no other possible solution for managing the storm water flows. Any modification of a desert wash that has a 100-year storm flow of 50 cubic feet per second (cfs), or greater, will require a modification approved by the Zoning Administrator as described in the [ESL zoning district](#).

C. Residential Development

1. Design residential street systems to avoid diverting or blocking historical drainage patterns.

2. Contour and align streets so that water is directed into the historical drainage course on the site.
3. During the construction phase of residential development, minimize erosion that may occur on disturbed ground surfaces, such as utility alignments, street cuts, etc.
4. Disperse on-site storm water flows from improved portions of residential properties to minimize off-site erosion, or direct flows into a defined drainage course to minimize erosion and maintain flow characteristics of the drainage way.

D. Utility Installations

1. Complete the installation of underground utilities so that there is little or no alteration of historical drainage patterns that exist within the development site.
2. Utility crossings of drainage ways should be limited to the minimum extent feasible.
3. Wherever possible, place utility crossings in conjunction with road crossings and diagonal to the flow path of the drainage way.
4. Place utility crossings in natural or man-made channels, below the maximum expected scour depth of such channels, in addition to the usual depth of cover.
5. Do not place utility corridors alongside drainage ways within the area that could be inundated in a 100-year storm flow, or through the native riparian vegetation that is adjacent to the drainage way.

E. Culverts and Grade Crossings

1. With the design of culvert capacities, determine the potential for clogging due to sediment and debris in the storm water flow.
2. At culvert entrances construct headwalls and wingwalls. In addition, an erosion resistant apron may be necessary when analysis indicates the need. Consult the FHWA's manuals regarding the design of such facilities. Also refer to Chapter 5 of this manual.
3. Consider the possibility of storm water flow over the roadway in the design of a culvert at a roadway crossing and provide erosion resistant bank protection on both the upstream and downstream side-slopes of the crossing, as needed.
4. Where "wet" crossings of washes are approved by Planning and Development Department Director and Community Services Department Director, or their respective designees, a concrete road surface may be necessary for that portion of the street that may be inundated during a 25-year storm flow. Concrete cut-off walls shall be designed and constructed on both the upstream and downstream sides of the roadway. All "wet" crossings shall be sign-posted to assure public safety.

F. Protection of 50 cfs Desert Washes

The goal of the ESL zoning district is to leave significant desert washes in place and in a natural condition when it is practical to do so. Site plan designs should accommodate natural desert washes in their native locations and condition to the greatest extent feasible. Significant desert washes as defined in the ESL zoning district are those having a 100-year storm water flow of 50 cfs or more.

Special note: The city has prepared maps of desert wash channels that have a capacity of 50 cfs or more, but it should be noted that no storm water flow calculations were made during the preparation of these maps. The purpose of these maps is to highlight drainage corridors that should be studied and evaluated to determine if they qualify as significant desert washes and to assure continuity of drainage flows across various properties.

The ESL zoning district provisions in the Zoning Ordinance include a procedure for a Wash Modification to consider the need for, and the resulting environmental character of, any proposed changes in the location, configuration, or condition of a significant wash.

ROADWAYS

2-2.300

This section focuses on minimum design guidelines for roadway improvements within the ESL areas.

Alternative design solutions shall be considered if appropriate technical analysis and documentation can demonstrate compatibility with the environmental management objectives for ESL areas.

Roadways can impact ESL areas not only during construction, but also over the life of their use. Determine ways to mitigate such impacts as obstructing natural drainage channels, introducing road surface pollutants and disrupting habitat conditions during the planning stages of the project proposal. This section provides guidance for ways to effectively mitigate some of these impacts.

Some of the goals to meet in the design and construction of roads in the ESL area are:

- A. No slope movement or surface subsidence from construction shall occur outside of the approved construction limits for the road project.
- B. Do not obstruct the capacity and function of drainage channels.
- C. Avoid creating artificial sub-basins with road construction and layouts unless specifically approved as a part of a subdivision plat.
- D. Maintain water quality by avoiding introducing surface run-off pollutants from road surfaces.
- E. Maintain connections between significant riparian habitats or vista corridors with the roadway layout.
- F. Replace native vegetation removed for roadway construction to the greatest extent possible.

GENERAL DESIGN FACTORS

2-2.301

In ESL areas, the location of a roadway (horizontally, vertically and in cross-section) should be compatible with the surrounding environment. The following factors should be considered in addition to design specifications for ESL area roadways listed in the Transportation Chapter, right-of-way (ROW) Section of this manual.

A. Location

Locate the roadway to minimize impacts to the natural environment, refer to Subdivision Street Planning Figure 2-2.2 below.

B. Alignment and Profile

Follow the topography of the area with the roadway design to minimize excavation and embankment scars. Curvilinear horizontal alignments and gently rolling profiles consistent with the natural topography minimize unnecessary disturbance to the existing environment.

C. Natural Features

Avoid significant natural features, such as stands of vegetation and rock outcroppings, when suitable alternative alignments are available.

D. Structures

Consider impacts on vegetation, topography, wildlife movements and the viewshed in the design and location of roadway structures.

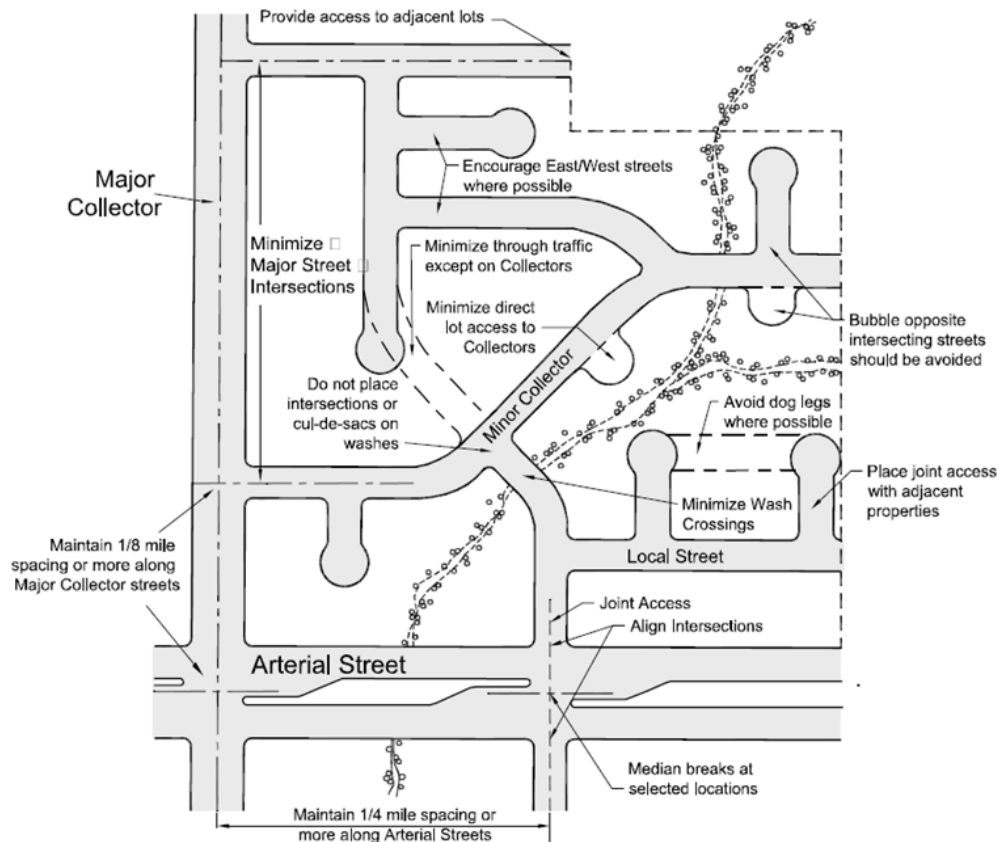

FIGURE 2-2.2 SUBDIVISION STREET PLANNING

SPECIAL CONSIDERATION FOR ROAD CROSS-SECTIONS

2-2.302

A. Street Rights-of-Way

Additional rights-of-way may be required for cut or fill slopes, bike paths, horse trails, traffic control devices, fire hydrants or other public facilities located adjacent to streets. Where cut or fill slopes extend beyond the rights-of-way, a permanent easement may be provided in lieu of increasing the width of the rights-of-way.

B. Shoulders

All roads within ESL areas should have improved shoulders. Construct shoulders with clean native topsoil that is free from roots, debris, heavy clay and large stones or rocks. Compact all shoulders to a minimum of 90 percent of maximum density.

C. Cross Slopes

In ESL areas it may be necessary to use roadway cross slopes to control drainage. The slope of shoulders should match the pavement cross slope.

D. Utility Locations

In general, place utilities within the improved area of the pavements and adjacent shoulders. If it is necessary to place utilities in a PUE of the road improvements, minimize the amount of grading, loss of native desert vegetation and impacts to the natural drainage character.

ROAD GRADING

2-2.303

This section establishes criteria for cut and fill slopes, slope stabilization, erosion controls and restoration of scarred areas due to roadway grading. All roadway improvement plans, and street design must be completed under the supervision of a registered Civil Engineer.

A. Side Slopes

1. Consider stability, maintenance and appearance of cut and fill slopes during construction. Use geotechnical reports for safe slope gradients.
2. The maximum slope gradient for fill slopes within the rights-of-way is 4:1 (horizontal to vertical) and for cut slopes is 3:1 (horizontal to vertical), unless otherwise approved by the Planning and Development Services Department and Transportation Department Directors or their designees.
3. In areas where the engineer anticipates unstable soils or potential erosion, flatter slopes or specific mitigation techniques may be accepted. Design measures to mitigate unstable slope conditions and potential erosion problems must be identified in the geotechnical report.
4. Steeper slopes are allowable provided that geotechnical conditions are properly analyzed, and a stable embankment is detailed on the construction plans. Guardrails are required along fill slopes steeper than 4:1 (horizontal to vertical).
5. The maximum height of cuts and fills for roadway improvements is 8 feet in the Upper and Lower Desert Landforms and 12 feet in the Hillside Landform, as measured vertically from the pavement surface to the natural grade at the toe or top of the constructed slope, see Figure 2-2.3, Hillside Landform Road Cuts.
6. When retaining walls are used, the exposed height should be the height of the retaining wall plus the vertical height of the retaining slope. In addition, these maximum heights will limit length as shown below.

Slope Height	Maximum Length
0-4 feet	None
6 feet	375 feet
8 feet	300 feet
10 feet	225 feet
12 feet	150 feet

7. Cut and fill slopes should maintain an average height of 6 feet in the Upper and Lower Desert Landform and 8 feet in the Hillside Landform areas for any

continuous slope. Determine the average slope height by using individual slope heights measured at 50-foot intervals.

8. Where there is a combination of cut and fill slopes at any station along the roadway, do not exceed a combined slope height of 12 feet in Upper and Lower Desert areas and 16 feet in Hillside areas.

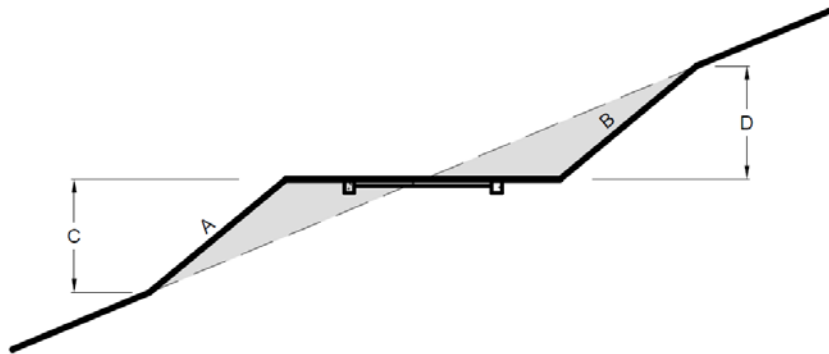

A: 4:1 SLOPE (3:1 WITH GUARD RAILS) C: 12' MAX. / 8' AVERAGE FOR EACH 50' LENGTH
 B: 2:1 SLOPE D: 12' MAX. / 8' AVERAGE FOR EACH 50' LENGTH
 C+D: 16' MAX.

FIGURE 2-2.3 HILLSIDE LANDFORM ROAD CUTS (DRAWING NTS)

9. Heights exceeding the above criteria may be allowed by the DRB or Zoning Administrator provided the applicant demonstrates that objectives of the ESL zoning district are met.
10. Round all slopes to blend into the existing terrain to produce a contoured transition from the slope face to the natural ground.
11. Planning and Development Services staff may require mitigation techniques for cuts and fills greater than 8 feet be presented to the DRB for approval. Slopes and fills must be engineered in accordance with the recommendations of the geotechnical report.

B. Retaining Walls

Retaining walls may be used to reduce the horizontal and vertical distances required to construct cut and fill slopes.

1. All retaining walls, regardless of height, shall comply with the city building code and conform to the following requirements. The heights and types of retaining walls may be subject to DRB approval as determined by the Planning and Development Services Director or designee, based upon the visibility and magnitude of the proposed structure.
2. Acceptable types of retaining walls include stone gravity, structural masonry and reinforced concrete. Do not use other types, such as metal cribbing walls and rock gabion walls, unless approved by the city.
3. Consider terraced walls in place of a single wall for instances requiring retaining walls more than 6 feet. The minimum dimension of the landscaped level located between the lower and upper terrace walls shall be at least equal to the visible height of the lower wall, but not less than 4 feet. Refer to Figure 2-2.8 Retaining Wall Dimensions.

4. In general, match the finish material and color of retaining walls with the surrounding natural stone, rock or soil color.
5. Plans for retaining walls greater in height than 3 feet must be signed and sealed by a registered Civil Engineer or Structural Engineer in the State of Arizona.

C. Drainage Controls

1. Design all drainage facilities to carry surface waters to their historical outfall.
2. Do not pond water above cut or fill slopes.
3. Construct and maintain erosion controls (temporary or permanent) to prevent erosion of all slopes and graded areas.
4. Provide surface drainage interceptors at the top of cut and fill slopes where surface runoff will create erosion problems.
5. Subsurface drainage facilities may be required for stability and protection of affected areas due to ground water seepage.

D. Slope Restoration

Restoration and stabilization of all exposed slopes created by grading shall be completed within 90 calendar days after rough grading of the roadway. Restoration shall consist of revegetation with native species of a type and mix consistent with local natural conditions and/or artificial weathering of rock faces. A revegetation plan including plant species, locations, sizes and methods of transplanting must be submitted for review and approval.

STREET INTERSECTIONS

2-2.304

Do not place street intersections within the alignment and floodplain of major or minor washes, on or within boulder clusters or other such sensitive environmental features.

STREET LIGHTING

2-2.305

Do not provide street lighting within the Hillside landform; refer to Chapter 2-1.1200 of this manual.

A. In the Upper Desert Landform

Where the average residential density is less than 1.5 dwellings per acre or the surrounding land use is some form of open space, provide street lighting only at intersections with major and minor collector streets. Where the residential density is higher or there are non-residential uses, provide street lighting at all intersections. Finish street lighting equipment to match the surrounding environment.

B. In the Lower Desert Landform

Where the average residential density is less than 1.5 dwellings per acre or the surrounding land use is some form of open space, provide street lighting only at intersections with collector or larger streets. In all other areas use street lighting based upon the latest International Illumination Society (IES) recommended standards that are based upon the land use and context of the street, refer to Chapter 2-1.1200 of this manual.

SIDEWALKS

2-2.306

A. In the Hillside Landform

Sidewalks are not required within the Hillside Landform.

B. In the Upper Desert Landform

1. Sidewalks are not being required where the residential density is less than 1.5 dwellings per acre or the adjacent land use is an open space area of at least 40 acres, except along arterial or larger streets.
2. Sidewalks are required in all other areas.
3. Sidewalks on one side only of a street may be permitted by the Planning and Development Services Director or designee if the street is accessed only on one side, the street is cul-de-sac less than 400 feet in length, or the local land slopes generally average 10 percent or more.

C. In the Lower Desert Landform

In areas where the average residential density is less than 1.5 dwellings per acre sidewalks are required along major collector or larger streets. Sidewalks are required in all other locations.

D. Other Considerations

Shoulders may be used as pedestrian ways provided safety is not compromised. In these cases, wider shoulders may be used in place of a concrete sidewalk.

BIKEWAYS

2-2.307

Scottsdale policy requires bikeways on all arterial and major collector roads, refer to the Transportation Chapter of this manual. However, this requirement is waived in the Hillside landform.

DRIVEWAYS

2-2.308

A. Residential Developments

In general, limit driveways in ESL areas to 1 per residence. However, additional and circular driveways will be permitted provided they do not adversely disrupt the surrounding natural desert environment.

1. The maximum linear grade of a driveway shall be 18 percent and the average grade for the length of the driveway shall be 12 percent.
2. Driveway length shall be measured from the property line to main entrance into the residence.
3. To minimize crossings of drainage ways, shorten the length of cul-de-sacs in steeper terrain and protect boulder clusters or formations, a single driveway may serve more than one residence but not more than four residences provided that:
 - a. The maximum length is 400 feet, unless specifically approved by the Planning and Development Services Director or designee,
 - b. The minimum width is 24 feet in the Upper and Lower Desert Landform and
 - c. The minimum width is 18 feet in the Hillside Landform.
4. Driveways greater in length than 150 feet or with grades steeper than 12 percent in Hillside areas are subject to prior approval by the Planning and Development Services Director or designee, as well as from the city's Fire

Department. Design such driveways based upon the following criteria and Private Driveway Design for Emergency Access. Additional information provided in the [Fire Code](#).

- a. Where the driveway gradient is 0 to 12 percent:
 - i. The driveway surface shall be all-weather,
 - ii. The minimum driveway width shall be 16 feet if it is longer than 200 feet, and
 - iii. A turn-around is required if the driveway length exceeds 200 feet.
- b. Where the driveway gradient is from 12.1 to 15 percent:
 - i. The driveway shall have a hard surface,
 - ii. A turn-around is required if the driveway length exceeds 200 feet,
 - iii. The minimum width shall be 16 feet if the driveway is longer than 200 feet (a 12 feet wide hard surface with 2-foot-wide compacted shoulders on each side may be used) and,
- c. Where the driveway gradient is from 15.1 to 18 percent:
 - i. The driveway shall have a hard surface,
 - ii. A turn-around is required if the length of the driveway exceeds 200 feet,
 - iii. The minimum width shall be 16 feet if the driveway is longer than 200 feet (a 12 feet wide hard surface with 2-foot-wide compacted shoulders on each side may be used).

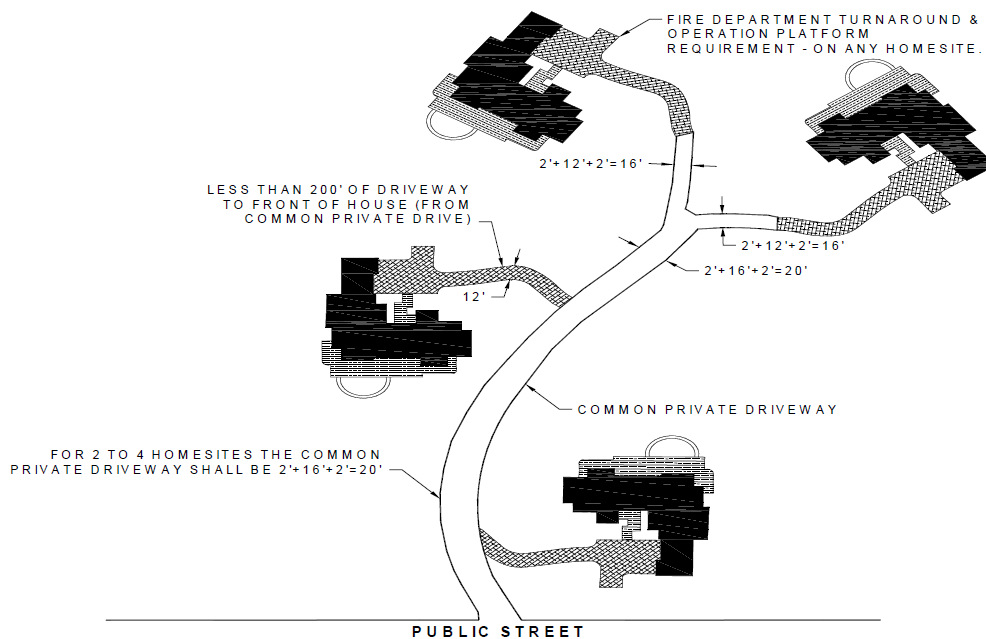
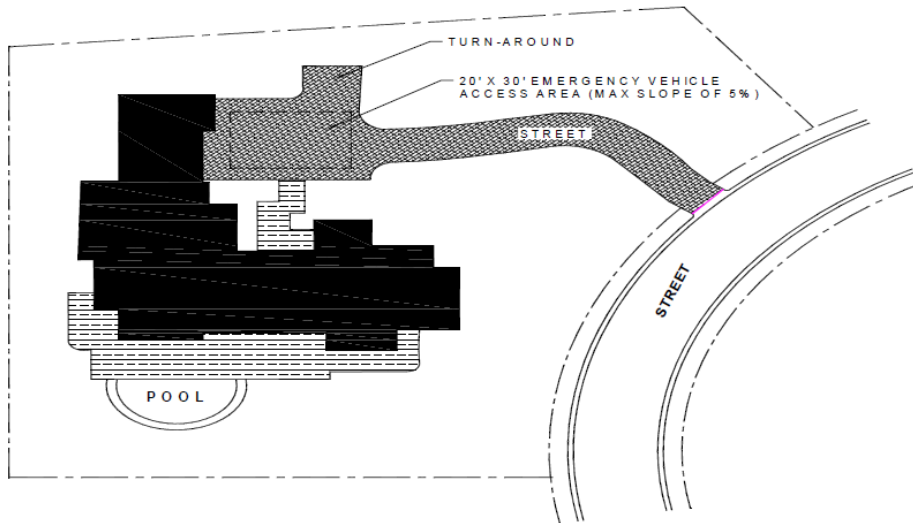

FIGURE 2-2.4 PRIVATE DRIVEWAY DESIGN FOR EMERGENCY ACCESS

5. Design driveways and parking areas for adequate vehicle maneuvering and turn around for a Single Unit Truck (SU) as defined by American Association of State Highway & Transportation Officials (AASHTO).
6. Provide an Operational Platform for Fire Access adjacent to the main building whenever the driveway exceeds 12 percent in grade or is longer than 200 feet. The minimum dimensions for this platform are 20 by 30 feet and the maximum

cross slope is 5 percent, refer to Operational Platform for Fire Access in this Section.

7. Where required, the turn-around shall be either a circular drive with a minimum radius of 40 feet 6 inches or a T-type hammer head with 16 feet by 76 feet dimensions, refer to Figure 2-1.2.
8. A turn-out is required along extended driveways at 300 feet intervals. The turn-out shall be at least 20 feet wide for a distance of at least 45 feet, refer to Fire Turn-out for Extended Driveways in this section.



O P E R A T I O N A L P L A T F O R M

A 20' X 30' EMERGENCY VEHICLE ACCESS (MAX 5% SLOPE) AREA SHALL BE PROVIDED ON ALL LOTS IN WHICH THE ADJACENT STREET OR DRIVEWAY GRADES ARE GREATER THAN A 12% SLOPE

FIGURE 2-2.5 OPERATIONAL PLATFORM FOR FIRE ACCESS

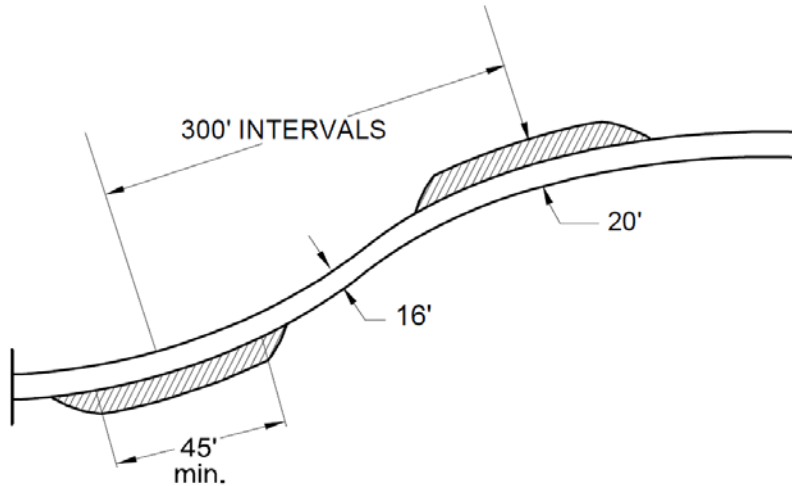

FIGURE 2-2.6 FIRE TURN-OUT FOR EXTENDED DRIVEWAYS

B. Locations

Locate driveways in the Hillside Landform a minimum of 100 feet away from the rights-of-way line of an intersecting street and a minimum of 25 feet from a side property line. In special cases the Planning Development Services Director or designee may make exceptions to this standard. Refer to Figure 2-2.7 Driveways on Hillside Landform.

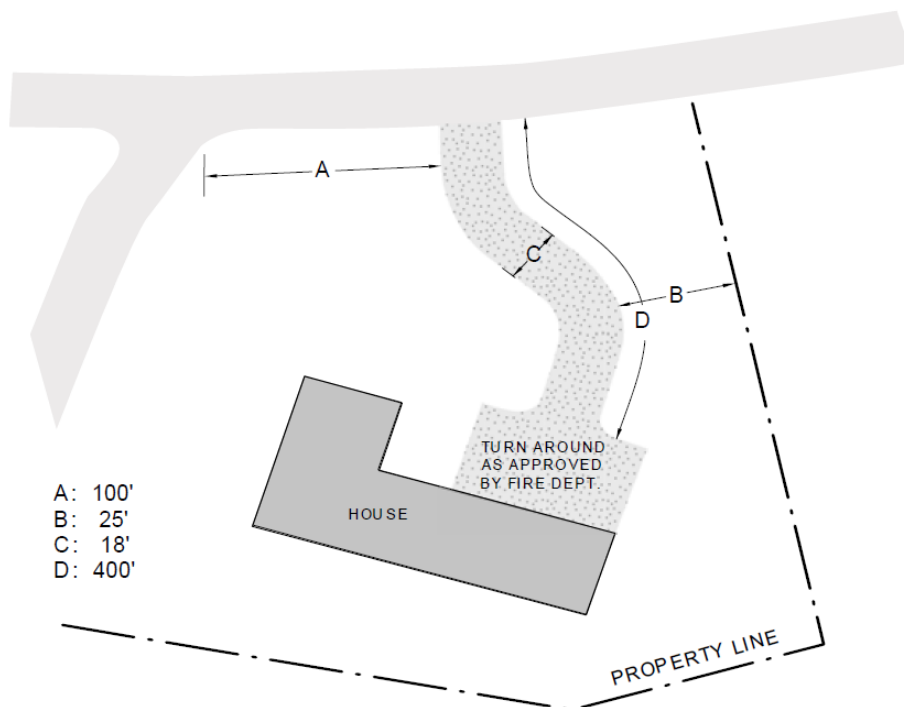

FIGURE 2-2.7 DRIVEWAYS ON HILLSIDE LANDFORM

C. Surfacing

Pave driveway aprons with asphalt, Portland Cement concrete or concrete pavers. Other types of stabilized surfaces, such as cemented native granite or approved

equal, may be allowed where it can be demonstrated that there would be no erosion from the surface and the construction will allow for the loading of emergency vehicles. Where sidewalks are used, design and build the driveway apron according to MAG standards.

SITE WORK

2-2.400

The intent of these guidelines is to promote creative design and innovative methods for site development within the ESL area. Modified grading guidelines may be allowed where it can be demonstrated that they achieve the goals and purposes of the ESL zoning district. Grading includes initial clearing, grubbing, excavating and placement of fill associated with any form of development.

This section establishes guidelines for grading which are intended to:

- A. Regulate the development of potentially hazardous terrain;
- B. Preserve the general visual character of graded sites; and
- C. Preserve native vegetation and wildlife habitat.

Consider the following key elements during the design and implementation of all grading activities:

- A. Conserve the natural environmental features and functions of the site.
- B. Design and construct grading to be compatible with the surrounding natural desert land.
- C. Use construction techniques that result in no slope movement or subsidence and the stabilization of hillsides, slopes or other areas subject to erosion or mass movement.
- D. Preserve the natural capacity of drainage courses and protect natural drainage ways, including the native vegetation associated with them.
- E. Control dust pollution and surface water runoff and related erosion during construction operations.
- F. Maintain the stability of underlying geological conditions wherever development is proposed, unless specific mitigation measures are proposed to assure safe development of the land.
- G. Do not alter drainage basin boundaries.
- H. Do not create any obstructions within any drainage channels.
- I. Do not increase the movement of sediment in volume or velocity as a result of any modifications to natural channels.
- J. Do not obstruct scenic, riparian or vista corridors. Preserve or restore them to a natural desert condition.
- K. Minimize topsoil and vegetation removal.
- L. Design and finish graded cuts and fills that are visible from adjacent properties in a manner that matches the surrounding native soils and rocks.
- M. Leave significant natural boulders and rock formations intact and minimize any damage.

APPLICABLE PROJECTS

2-2.401

A grading permit is required of all development projects, private or public, for ESL areas, except as exempted herein. Categories for general grading that require a grading permit include but are not limited to the following:

- A. Residential development for a single lot of any size.
- B. Residential or mixed-use development that requires a subdivision plat or development plan.
- C. All other nonresidential types of development.
- D. The clearing, brushing or grubbing of any area where grading for any purpose is to be done.
- E. Temporary off-site stockpiling of fill material.
- F. Driveways and parking areas where the graded area will be greater than 500 square feet.
- G. Recreational facilities such as golf courses, parks and ball fields.
- H. Educational institutions and schools (public or private).
- I. Public service facilities such as fire stations, police stations and libraries.
- J. Public infrastructure facilities such as water storage tanks, flood control structures and wastewater treatment facilities.

EXEMPTIONS

2-2.402

The following activities are not required to have a grading permit:

- A. Resurfacing or maintenance of an existing paved surface.
- B. If authorized by a building or zoning construction permit, excavation below finished grade when the excavation is for the construction of a basement, foundation, wall or swimming pool.
- C. Exploratory excavation performed under the direction of a registered soil engineer or geologist, provided all excavation is properly backfilled.
- D. Archaeological exploration of an archaeological site recognized by the State.
- E. Removal of native vegetation when being performed under an existing de-vegetation permit.
- F. Underground utility installations under a graded or paved roadway surface.
- G. Grading for maintenance purposes of an existing private road, access or driveway; if it existed prior to the adoption of the ESL zoning district or that it was established in conformance with this section.
- H. Land uses which are exempt under statutory regulations.

GEOTECHNICAL INVESTIGATIONS

2-2.403

Most grading activities in ESL areas require some level of geotechnical investigation and analysis, the level of which shall be left to the discretion of the city and the engineer based upon the known conditions on the site. Such studies are required where there are known or likely occurrences of unstable slopes, exposed or shallow bedrock, on-site materials that may bear radon elements, soils with high shrink/swell potential or the presence of caliche hardpan. Exceptions to this requirement may include the construction at single-family residences where the improvements are not occupied structures or are not attached to any rock materials.

MAXIMUM GRADING AREA

2-2.404

- A. Grading can occur only within an approved construction envelope.
- B. The maximum grading area for any parcel is based on NAOS requirements. Grading is not permitted within designated undisturbed NAOS areas. When utility trenches cannot be reasonably provided without crossing designated natural or open space areas, such trenching activities may be allowed provided all disturbed areas are revegetated to a natural condition.
- C. The actual graded area for any parcel must be less than or equal to the developable area of a parcel as specified in the ESL zoning district. If a conflict arises, the terms and conditions of the ESL zoning district shall govern.
- D. Site grading that impacts special features is prohibited; these areas are identified on [ESL zoning district Special Features Map](#) or the [High Priority NAOS Locations map](#). Site work should be planned to avoid cutting off significant riparian and habitat corridors. Buffer areas should be provided around developed sites. The design of final grading must consider view shed impacts.
- E. Grading is prohibited where geologic hazards are identified, unless a specific exemption to this guideline has been approved by the Planning and Development Services Director or designee, as the result of the recommendation of the geotechnical investigation. Such areas may include but are not limited to boulder rolling, rockfalls, slope collapse, and talus slopes.

The Planning Development Services Director or designee may approve modifications to these grading limits for special conditions such as unique soil or geologic conditions.

GRADING DESIGN GUIDELINES

2-2.405

A. **Cut and Fill Slopes**

- 1. Maximum Slope Gradient
 - a. Use geotechnical reports to provide recommendations for safe slope gradients for exposed cuts or fill materials. Unstable slope conditions and potential erosion problems must also be identified within the geotechnical report as well as adequate design measures to mitigate these conditions.
 - b. Typically, safe slope gradients in ESL areas range between 4:1 and 2:1 (horizontal to vertical). For exposed cut slopes the structural nature and strike and dip of the native soil or rock material being cut into governs the appropriate slope gradient. For exposed fill slopes the appropriate slope is based on the natural angle of repose based upon the structure of the fill material.
 - c. Where applicable, incorporate revegetation techniques within the slope design. In general, the steepest slope for revegetation or landscaping is 3:1 (horizontal to vertical).
 - d. Conform slopes adjacent to roadways to the requirements in Section 2-2.300 of this manual.
- 2. Heights
 - a. In general, do not exceed 8 feet for the height of cuts and fills in ESL areas, as measured vertically from the finished grade to the natural grade.

- b. Exceptions to this guideline are subject to the approval by a Planning and Development Services Director's designee where a cut surface will be entirely hidden by a building.
 - c. The Planning and Development Services Director's designee may allow cut and fill heights greater than 8 feet where it can be demonstrated that the ESL zoning district objectives are met.
 - d. The Planning and Development Services Director's designee may require cuts and fills greater than 8 feet to be subject to DRB approval.
 - e. Any cut or fill on a property subject to the ESL zoning district regulations with a vertical dimension greater than 8 feet shall require a specific staff review. For properties subject to the Hillside District, a specific staff review shall be required where there is an exposed fill greater than 4 feet in vertical dimension or cuts greater than 8 feet in vertical dimension.
3. Slope Shaping
 - a. Round all man-made slopes at the edges to blend into the existing terrain adjacent to the new slope to produce a contoured transition from the slope face to the natural ground.
 - b. Incorporate undulating slopes in all man-made slopes greater than 500 square feet in area to reflect the natural undulations occurring in the adjacent desert.
 4. Slope Revegetation
 - a. Restore all exposed slopes created by grading to a natural condition and stabilize them to minimize erosion and slope collapse or wasting.
 - b. Restoration shall include revegetation with native species as found on similar natural slopes in the area.
 - c. Treat cuts into rock or caliche with artificial weathering techniques.
 - d. Irrigate all revegetated areas for at least 3 years or until the vegetation has become established.
 - e. Do not use imported decomposed-granite soil-cover/mulch in revegetated areas or in any place within NAOS areas.
 5. Setbacks

Building walls and other structures shall be set back from the top/toe of slopes far enough to assure stability and prevent damage from erosion. The engineer/architect shall specify the setback on the plans. Larger setbacks may be enforced to meet the intent of ESL zoning district.
 6. Drainage Considerations
 - a. Construct and maintain erosion controls (temporary or permanent) to prevent erosion of all slopes and graded areas.
 - b. Design building sites to carry surface waters away from buildings at a minimum grade of 2 percent for a minimum distance of 10 feet from any buildings.
 - c. Provide surface drainage interceptors at the top of all cut and fill slopes where surface runoff will create erosion problems.
 - d. Do not pond water above cut or fill slopes.

- e. Subsurface drainage facilities may be required for stability and protection of affected areas due to ground water.
- 7. Building Height
Establish all building pads and finish floor elevations so that the maximum allowable building height does not exceed the building height outline limit as specified in ESL zoning district.

B. Terraces and Retaining Walls

The use of retaining walls is an effective means to minimize grading, reduce the height of cut or fill slopes and stabilize slopes. The heights and types of retaining walls may be subject to DRB approval, as determined by a Project Coordination Manager. All retaining walls, regardless of height, shall comply with the city Building Code and conform to the following requirements.

1. Terraces
 - a. Terracing may be employed where deemed necessary by the engineer or where desired to reduce the amount of area to be graded.
 - b. To minimize the impacts of the grading on a project, terracing may be required by Planning and Development Services staff.
 - c. In general, the minimum width of terraces shall be at least 4 feet wide or equal to the height of the lower retaining wall if it is taller than 4 feet, to allow for the future maintenance of the retaining wall and allow for landscaping materials that will screen the visibility of the walls.
2. Types of Walls
 - a. Acceptable types of retaining walls are stone or concrete gravity, structural masonry and reinforced concrete.
 - b. Other types such as metal cribbing walls or rock gabion walls are not permitted unless approved by Planning and Development Services Director or designee or the DRB.
 - c. The finish material and color of retaining walls should match the surrounding natural desert stone, rock or soil color.
3. Alignments of Walls
Use undulating or angular alignments for all terrace walls greater than 50 feet in length.
4. Heights
 - a. Do not exceed 6 feet for the exposed height of any single retaining wall in ESL areas, as measured vertically from the inside ground level to the outside ground level as shown in Figure 2-2.8 Retaining Wall Dimensions.
 - b. Use terracing where the vertical height to be contained by the retaining wall exceeds 6 feet of fill material or 8 feet of cut, as shown in Figure 2-2.8 Retaining Wall Dimensions.
 - c. Meet structural stability for overturning, slope sliding and drainage considerations for all walls, regardless of height.
 - d. The maximum face height of a wall that combines a retaining wall and a solid wall shall be 10 feet. The maximum height of the wall above the retaining wall structure as measured from the retained ground level shall meet the normal zoning wall height standard.

- e. The maximum face height of a combination of retaining wall and view fence shall be 12 feet. The maximum height of the wall/view fence above the retaining wall shall meet the usual zoning wall height standard.

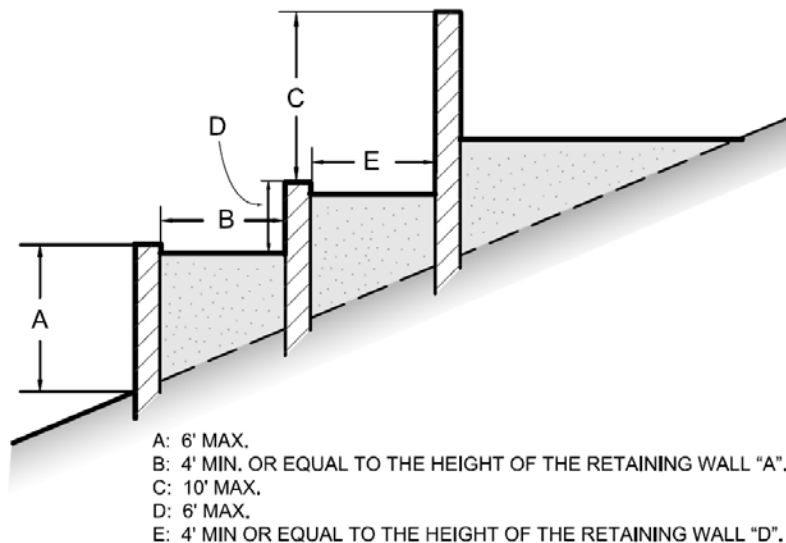

FIGURE 2-2.8 RETAINING WALL DIMENSIONS

C. Site Restoration

1. Required Restoration

Revegetate all disturbed areas. All revegetation shall be done with native species in a comparable density and pattern to that which exists upon the undisturbed adjacent areas unless otherwise approved by staff.

2. Slope Protection

On slopes where erosion may be a problem, or the slope materials and/or gradient will not readily support soil binding plants, hold the plant material in place by anchored straw mulch, erosion control fabric or an equivalent material.

3. Plant Materials for Slope Restoration

Where the slope restoration includes the use of revegetation of native desert plants, use those plants that occupy similar natural desert slopes in steepness and orientation in the area.

4. Timing of Slope Restoration

Complete all site restoration for any type of development within 90 days of the completion of work or prior to the issuance of a C of O, whichever occurs first.

D. Construction of Fills or Embankments

1. Fill Materials

Comply with the design engineer's recommendations for fill material and preparation of areas that are to receive fill. At a minimum, fill material should not contain any organic material, building materials, plastics, metals, hazardous wastes or refuse debris. Do not bury or place rocks, pieces of concrete or asphalt pavement or other irreducible material with a maximum dimension greater than 8 inches in any fill unless their placement has been specified and

inspected by the engineer. Place and compact all fills in accordance with the engineer's specifications.

2. Expansive Soils

The design engineer must insure that there will be no adverse impacts created by expansive soils. Should the engineer's investigation reveal the presence of expansive soils, the grading plans and specifications shall address how these soils will be managed.

3. Excess Material

Haul excess material to an appropriate off-site disposal area that has been approved by the Planning and Development Services Department. The disposal area must be outside of any Hillside landform area. An off-site hauling permit may be required from the city.

4. Dust Control

Apply approved dust control methods during all grading and until revegetation or site restoration is complete. Prior to the start of grading activities, a dust control permit must be obtained from the Maricopa County Health Department.

SITE DESIGN GUIDELINES

2-2.500

Consider the following key elements in site design for any proposed development for the protection of the unique visual quality and the native desert environment in the ESL area:

- A. Preserve view corridors along significant public transportation routes.
- B. Minimize scarring of the natural topography.
- C. Preserve existing vegetation as much as is feasible.
- D. Preserve drainage ways as view and wildlife corridors, thus providing open space connections throughout proposed development areas.
- E. Protect significant visual features such as peaks, ridge lines, rock outcrops, boulder fields and significant stands of vegetation wherever feasible.

GENERAL DESIGN GUIDELINES

2-2.501

The following guidelines apply to all areas that are visible from public viewpoints or nearby development, which shall be designed and sited to blend into the landscape.

A. Site Development - Buildings, Structures, Walls and Fences

- 1. Blend all exterior finish surfaces with the color and texture of the surrounding stone, rock or soil color.
- 2. Do not use reflective building materials. Recessed window and entry openings and deeper roof overhangs are encouraged.
- 3. Preserve the ridge line silhouette of significant topographic features by locating all improvements below the ridge line and using a finished height that does not protrude into the silhouette as viewed from nearby public roads.
- 4. Match and blend buildings and surrounding improvements with the form of the landscape. Use stepped floor elevations to avoid massive building forms and wall surfaces that contrast with the surrounding terrain.

5. Use exterior lighting fixtures that are recessed or shielded so that the light source is not visible from a public viewpoint or other development in the immediate area. Direct building mounted lighting downward.
6. Screen all exterior mechanical equipment with material complementary to both the structure and the surrounding environment.

B. Walls and Fences

1. Perimeter Walls
 - a. In general, perimeter walls are not a preferred approach to providing privacy and minimizing the impacts of nearby roads. Consider using walls around individual building envelopes, mounding that blends into the terrain and other such treatments. If perimeter walls are used, set them back 25 feet from a perimeter street right-of-way or a property line.
 - b. Use undulating, notched or similar non-linear alignments for perimeter walls. They should move around significant natural desert vegetation leaving substantial room for these plants to survive (3 feet out from the canopy of desert trees and at least half the height of saguaros).
 - c. Use designs and materials for perimeter walls that reflect the form, materials, texture and colors of the natural desert setting.
 - d. Undisturbed NAOS does not include the area within 5 feet on either side of a perimeter wall, although this area may be considered as revegetated NAOS where allowable.
 - e. Maintain continuity of NAOS; do not separate adjacent NAOS areas with perimeter walls.
 - f. Do not cross minor or major watercourses with perimeter walls.
 - g. Install openings in perimeter walls at least 3 feet in width and height, at intervals no greater than 200 feet to allow wildlife movement.
2. Individual On-Site Walls
 - a. Where on-site walls are placed adjacent to NAOS areas at least 50 percent of the wall surface shall be a view fence.
 - b. Do not cross or enclose minor or major watercourses with on-site walls.
3. Fences

Fences may cross drainage ways if they do not impede storm flows, collect debris in storm flows or block the passage of wildlife.
4. Walls Along Vista Corridors
 - a. Walls located immediately adjacent to a Vista Corridor easement are limited to a height of 3 feet. Set back taller walls parallel to Vista Corridor easements an additional 4 feet for each foot of wall height above 3 feet.
 - b. Where channel capacity is sufficient to contain the 100-year storm flow, place walls along the edge of Vista Corridor easements a minimum of 2 feet back of the grade break at the top of the natural channel of the wash.
5. Sound-buffer Walls Along Roads

Sound-buffer walls are not allowed where there is a Scenic Corridor Easement along a roadway and are generally discouraged in other locations. Naturally contoured and landscaped berms may be permitted subject to the specific approval of the DRB. Exceptions to this may be considered along roads with 4

or more lanes where the adjacent subdivision has no Scenic Corridor Easement. The design of any wall in such a case shall be subject to specific approval by the DRB. The wall design shall incorporate rustic and dark materials, provide openings and breaks for washes and adjacent NAOS areas, and shall include variations in vertical and horizontal alignment.

C. Ancillary Improvements

1. Corral Areas

Do not place corral areas over or across minor or major watercourses, boulder clusters or rock formations. Also, do not place them on areas with slopes more than 15 percent.

2. Tennis Courts

Do not build tennis courts on terrain with slopes more than 15 percent. On slopes of 3 percent or more cut tennis courts into the slope rather than placing them upon fill material. The screen fencing should be a dark color, preferably black or dark brown.

3. Parking Areas

- a. On slopes of 5 percent or more divide parking areas into sections generally with no more than 50 spaces.
- b. Use landscaped islands to transition the grade breaks across parking areas.
- c. Parking area run-off should be directed into detention basins, as applicable.
- d. The maximum height of light poles in parking areas is 16 feet.

D. Other Site Design Considerations

1. Refer to the Zoning Ordinance and the Outdoor Lighting section in this manual for light standards within ESL areas.

2. Firebreaks

Maintain a Defensible Space firebreak within 30 feet of any occupied structure. A firebreak shall consist of a maintained area where the typical herbaceous and grass plant materials that grow annually are kept clear. This does not include the removal of any native perennial plant materials, except those that might overhang structures. In lieu of the removal of certain plants, fire-rated walls and/or exterior fire sprinklers may be considered. Cantilevered, bridged or similar types of structures may be allowed subject to the approval of the city's Fire Department. Native trees may be trimmed within this Defensible Space. In addition, gutters and eaves should be kept clear of debris; flammable materials should not be stored or stacked; and a hose connection should be provided near where building walls are adjacent to NAOS areas. Consult the city's [Invasive Plants brochure](#) and [wildland fire prevention](#) information for assistance in identifying and eradicating these plants.

3. NAOS Setbacks

NAOS easement may be located adjacent to site walls, driveways, parking area or similar construction if the first 5 feet of NAOS out from the improvement is revegetated, as provided in the Zoning Ordinance. The NAOS easement shall be placed at least 5 feet away from a roofed structure, with the next 5 feet out from the structure being revegetated area, refer to below.

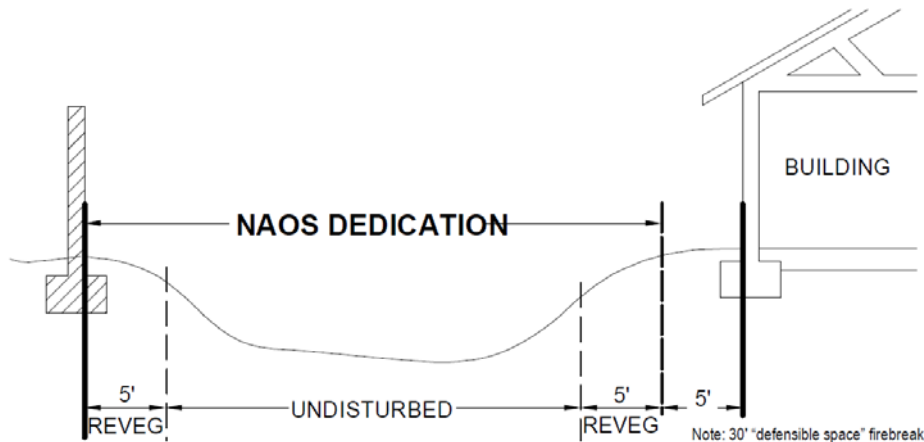

FIGURE 2-2.9 NAOS LOCATION GUIDE

4. Landscaping
 - a. The palette of plants that can be used for areas that are not enclosed or trees that exceed a mature height of 20 feet are listed on the city's [Indigenous Plants for Environmentally Sensitive Lands publication](#). The use of any other plant materials in such situations shall be subject to the specific approval of the Zoning Administrator or designee.
 - b. Use hydro-applications in revegetated areas only as a supplement to the use of container or relocated plant specimens. The mix in terms of plant types and ratios shall be based upon the native mix and density that occurs on the site.
 - c. Design and install swimming pool filtration systems in such a manner that no flows shall enter any NAOS areas or drainage ways.
 - d. Landscape lighting is not allowed within NAOS areas.
5. NAOS Enhancements
 - a. In-fill Areas (refer to the Zoning Ordinance)
 - i. The type or cause of the man-made or natural disturbance needs to be identified before any enhancement can be considered. The most common disturbance would be an historic brush fire.
 - ii. On-site vegetation surveys need to be conducted and compared with surveys of undisturbed natural areas in the vicinity to establish the appropriate types of plant materials and planting densities to be used.
 - iii. The perimeter of the disturbed area to be enhanced shall be identified on the revegetation plans as well as staked on-site during installation of the plant materials.
 - b. Native Plant Replacement
 - i. If a native plant dies that qualifies for protection under the Native Plant Ordinances (refer to the Chapter 10 of this manual, the Zoning Ordinance and Chapter 46, Article V of the City Code) and is located within 50 feet of an improved area, it may be replaced by a plant of the same species.
 - ii. The minimum replacement size is a 15-gallon container size and the maximum size is a 24-inch box container size.

- c. Edge Area Enhancements
 - i. Additional native plant specimens may be added to NAOS areas within 50 feet of improved areas if the plant material is native to the site.
 - ii. The addition of the specimen shall not result in a plant density that is significantly denser than what is typical within the vicinity of the site.
 - iii. Decomposed granite and other non-native materials may not be added to the NAOS area.
 - d. General Limitations and Requirements
 - i. No motorized vehicles can enter the NAOS area in conjunction with the installation of any NAOS Enhancements.
 - ii. Plant material installed with any NAOS Enhancement shall be watered for a period not less than 18 months and not greater than 36 months to establish the plant survival. The watering technique shall not include any permanent irrigation facilities. All temporary irrigation materials are to be removed once the establishment irrigation period has ended.
6. NAOS Maintenance
- a. It is the intent and definition of NAOS that it be natural or naturalized Sonoran Desert land that is kept in a self-sustaining, undisturbed and natural condition (refer to the Zoning Ordinance).
 - b. These areas are required to be maintained as natural areas by designation and practice (refer to the Zoning Ordinance). The basic intent is that these areas should not be subjected to any form of regular maintenance.
 - c. Certain maintenance practices within NAOS areas are considered acceptable within specific limitations:
 - i. Removal of trash and debris – non-native material that is blown onto, washed onto or dumped in an NAOS area should be removed to allow the NAOS area to remain in a stable natural condition.
 - ii. Limited clearing and trimming of flash fire fuels as prescribed in printed materials prepared by the Fire Department can maintain a safe environment for habitable structures (refer to D.2 above).
 - iii. Limited clearing of debris and trimming of live plant materials that may obstruct the flow path in a wash (subject to confirmation by Drainage Inspection staff).
 - iv. Removal of non-native and invasive plant materials. The preferred technique for removal is to dig out the entire plant or to use a “Weed Wrench”, particularly on younger specimens. For removing larger Desert Broom and Mexican Palo Verde specimens, the use of Dow AgroSciences The Milestone VM (10% solution), or approved equivalent, directly on the stump after the trunk and branches have been removed is an acceptable technique.
 - d. Land repair using boulders, or any form of stone shall only use rock materials that are native to the site.
 - e. Certain practices are not acceptable in the maintenance of NAOS areas:
 - i. No motorized vehicles may enter NAOS areas. All materials being removed should be removed on foot or with the aid of a wheelbarrow, if

a singular path is not used for the wheelbarrow trips. Compacted soil thwarts future native plant growth and encourages undesired invasive plants.

- ii. Raking or other methods of dressing the soil are not to be used. Disturbed soils encourage and facilitate undesired invasive plants.
- iii. The use of pre-emergent herbicides, pesticides and other such chemical applications particularly by spray methods, are not allowed except the specific DOW AgroSciences product or approved equivalent as described above. Such applications may damage nearby native plant materials and may wash downstream and damage native vegetation on other properties.

Section 2-3

DEVELOPMENT PLANS & MASTER DEVELOPMENT PLANS

2-3

This section provides general guidance for development applications that require Development Plans and Master Development plans, either by the submittal requirements of the Zoning Ordinance or a stipulation of a Zoning District Map Amendment.

DEVELOPMENT PLANS

2-3.100

The requirements for a Development Plan (DP) are project specific, and the Zoning Administrator will determine the plans and design concepts that need to be included in an application for the Zoning District Map Amendment. The following is a general overview of the Development Plan (DP) contents that may be required:

A. Development Program - List of Land Uses and Associated Density, Floor Area, Etc.:

1. A listing of proposed land uses along with supportive information such as the maximum number of dwelling units, travel accommodation units, the proposed maximum density per gross lot area, floor area, the floor area ratio (FAR) or gross floor area ratio (GFAR) non-residential uses in the Downtown Area for, and the total gross floor area. Please refer to the definitions of FAR and GFAR in the Zoning Ordinance.
2. A narrative description of the land use assumptions used in the modeling of transportation, and water or wastewater infrastructure systems.

B. Development Program / Development Standards:

1. The development program is to include the property development standards for the proposed development, such as the setbacks, stepback, lot area, FAR, or GFAR in the Downtown Area for non-residential uses, density, building height maximum, rooftop appurtenance heights and coverage, (for the entire site and for each proposed building).
2. The applications for zoning district map amendment to a zoning district that allows land uses to be added as part of the development plan, may include a list of land uses that are proposed to be allowed that are not otherwise specified in the districts' allowed land uses.
3. A visual depiction of the proposed development standards, such as site plans or cross-sections that demonstrate the proposed standards on the property and relate the proposed standards to existing development on adjacent properties.

C. Site Plan

An application for zoning district map amendment is to include a site plan in accordance with the Planning and Development Services' Plan & Report Requirements for Development Applications checklist.

D. Drainage Report - Including Basis of Design:

A drainage report is to be provided in accordance with Chapter 4 of the DSPM.

E. Transportation Analysis and Concepts:

A Transportation Impact and Mitigation Analysis (TIMA) is to be provided in accordance Chapter 5 of the DSPM.

F. Conceptual Open Space Plan:

An open space plan is a form of site plan that depicts any proposed public and private open spaces areas, including conceptual improvements, acreage, use, and ownership. The open space plan is provided in accordance with the Planning and Development Services' Plan & Report Requirements for Development Applications checklist.

G. Transitions Plan:

The transitions plan may be a combination of the plans (site plan, site sections, landscape plan, site details, etc.) that depicts the methodology utilized to mitigate existing and planned sensitive uses from the proposed development. Sensitive uses typically include residential, open space, cultural, environmental, and educational uses. The method of mitigation may include, but need not be limited to, perimeter screen walls, landscaping areas, setbacks, building height limitations, orientation of windows, screening of service areas, etc.

H. Parking Plan:

The parking plan is an analysis of required parking for the proposed development including base requirements along with other supportive analysis such as a Mixed-use Shared Parking Program or a special uses parking analysis for those land uses not clearly identified with requirements in the Zoning Ordinance. The parking plan may also include a Parking Master Plan that complies with the requirements of the Zoning Ordinance.

I. Cultural Amenities Plan:

1. The Cultural Amenities Plan is a written description, which may include a plan, that may include the following:
2. A conceptual public art proposal, including proposed locations, and timing improvements;
3. A conceptual public event facility, including proposed location, management, and function;
4. Provisions for non-profit cultural facilities, including type, location, management, and timing;
5. Provisions for an in-lieu payment to the City Cultural Trust Funds; or
6. Methodology to comply with the Cultural Improvement Program requirements.

J. Sensitive Design Concept Plan:

The Sensitive Design Concept Plan is a general set of character design guidelines that are consistent with the established city design guidelines for the proposed development's pedestrian facilities and amenities, outdoor lighting, landscaping elements and materials, building design and orientation. The intent of the guideline is to establish a design framework for a subsequent Master Design Concept Plan, if required, and future DRB applications for the development of the proposed development project.

K. Conceptual Signage Plan:

The Conceptual Signage plan is a general set of character design guidelines for large developments to maintain continuity in development themed signage and may include signage locations and types.

L. Special Impacts Analysis:

1. The Special Impact analysis addresses specific characteristics that are unique to the development area and may address influence from abutting development. The analysis may be required to include a/an:
2. Outdoor lighting mitigation plan that includes the proposed measures to limit outdoor lighting trespass on adjacent properties;

3. Dust control plan that incorporates the methodologies to be utilized to minimize the dust generated from non-paved areas and dust generating uses of the site;
4. Noise mitigation plan is the proposed measures to limit noise trespass on adjacent properties.
5. Height mitigation plan – analysis and demonstration of the concepts used to mitigate the appearance of the maximum height within the proposed development to the existing development that is adjacent and abutting the Zoning District Map Amendment development application.
6. Design character transition guidelines incorporate the methodologies to be utilized in the design of the proposed development to transition and respect the design character of an adjoining development or area.

M. Conceptual Phasing Plan:

The Conceptual Phasing plan typically consist of the written description and graphic plan indicating the proposed phasing of on-site buildings, structures, infrastructure facilities, offsite infrastructure facilities – when required, and the proposed management plan for maintaining undeveloped or partially developed areas of a development project until development has begun on those areas.

N. Building Height Plan:

The Building Height plan is a site plan with the building roof shown, and the height points of a building’s roofs, parapets, and rooftop appurtenances identified. The heights identified are to be provided in accordance with the building height definition specified in the definition of the Zoning Ordinance. In addition, the building height plan may include building elevations that identify the height points of a building’s roofs, parapets, and rooftop appurtenances.

DEVELOPMENT MASTER PLAN

2-3.200

The Development Master Plan is the general document illustrating the entire property subject to master planning. The Development Master Plan typically is comprised of several master plan components, such as the Master Phasing Plan, Master Drainage Systems Plan, Master Transportation Systems Plan (MTSP), Master Planned Property Plat, and other master plan components specified in Zoning Ordinance or Zoning District Map Amendment stipulations.

DEVELOPMENT MASTER PLAN REQUIREMENT

2-3.201

- A. A Development Master Plan is required by the stipulations of a Zoning District Map Amendment, or by the Zoning Administrator as specified in Section 7.830 of Article VII of the Zoning Ordinance. The property owner(s) shall obtain approval of a Development Master Plan prior to the first approval of a DRB application for development of the property.

The Development Master Plan may be required for a proposed development project based of the following significant factors, such as, but not limited to:

1. The development is a large area of undeveloped land that does not have existing infrastructure (street, water, wastewater, stormwater (drainage)to support it;

2. The intensity of the development warrants significant modifications to existing infrastructure (street, water, wastewater, stormwater (drainage), etc.);
3. The phasing of the development is to be completed over an extended period;
4. The area of development consists of multiple property owners which may include different land uses, SRC and zoning requirements, development agreement obligations, or other environmental conditions that affect the property;
5. The scale and impact of the development may adversely affect the abutting neighborhoods; and/or
6. The character of common elements such as streetscapes, open space corridors, common facilities as well as design themes and guidelines to be utilized for the development and public facilities.

All development master plan shall be prepared to scale and accuracy commensurate with its purpose of the master plan

DEVELOPMENT MASTER PLAN APPROVAL

2-3.202

A Development Master Plan (DMP) will be processed by city staff as a DRB application. In accordance with Section 7.830 of Article VII of the Zoning Ordinance, the Community Sign District Plan, Master Sensitive Design Concepts Plan, and the Master Planned Property Plat shall be subject to the approval of the DRB as a standard development review application. The Master Parking Plan shall be processed in accordance with the provisions of Article IX of the Zoning Ordinance. All other master plan components shall be subject to the approval of the Zoning Administrator as minor development review (Staff Approval) application.

DEVELOPMENT MASTER PLAN COMPONENTS

2-3.203

A DMP has several components. A complete list of these components is contained in Section 7.830 of Article VII of the Zoning Ordinance. City staff will determine which components are required to be part of the DMP. Each component is explained in two parts: Performance standards, and Plan details. The details of the plans are to illustrate how the Performance Standards will be met. City staff may allow plans to be combined if the information on the plan is clear.

A. Master Phasing Plan

1. Performance Standards. The Master Phasing Plan is:
 - a. An outline of the order and general timing of development of the different areas of a development project.
 - b. The methodology to implement the Implementation Schedule that is to be part of the Traffic Impact & Mitigation Analysis (TIMA) and TIMA Report to construct the circulation facilities, including traffic signals.
2. Plan Details. The Master Phasing Plan is to include:

A narrative explanation and illustrations describing the order, timing, and location of construction of the development project, and the property owner responsible for each phase of the development and related improvements.

B. Master Sensitive Design Concepts and Plan

1. Performance Standards. The Master Sensitive Design Concepts and Plan is to provide written and illustrative design guidelines and standards that are unique to the proposed development project and reasonably compatible with the surrounding area and properties. Unless otherwise determined by city staff, the plan must incorporate written and illustrative design guidelines and standards to:
 - a. Provide buffers and assist in minimizing adverse impacts that an adjacent development may pose on the proposed development project or that the proposed development project may pose on adjacent developments. This may include using building scale or massing near the perimeter of the project that is similar to buildings on the adjacent property; using trees and other landscape plant material as to screen the development project; using wide perimeter open space areas to separate development on adjoining property; and/or building design techniques to maximize sound attenuation.
 - b. Identify open space areas to preserved, such as scenic corridors, vista corridors, major buffers, etc., that capitalize on mountain or other scenic views, natural terrain and washes. In addition, open space areas in a development project are to be coordinated with open space areas identified on adjacent parcels.
 - c. Preserve, maintain, and incorporate environmental and natural features, which include, but are not limited to, rock outcroppings, vegetation clusters, washes, prime wildlife habitats, floodplains, groundwater recharge zones, prime wildlife habitats, micro-climates, etc.
 - d. Allocate open space throughout a development project and prevent large quantities of open space allocations to be on one parcel or development site while providing little or no open space for other parcels or development sites.
 - e. In campus style developments, open space areas are to be scaled based on the horizontal and vertical scale of the proposed buildings adjacent to open space areas. This is to ensure that open areas are usable and proportional to the built environment.
 - f. Establish architectural and landscape themes for the development project's buildings, landscape, common areas, and community features and structures. Community features and structures include, but are not limited to, walls, fences, mail boxes, ramadas, open space areas (parks, pedestrian, passive, etc.), streetscapes, sidewalks, paths, trails, multi-use trails, site and common accent lighting, plant pallet(s), revegetation techniques and methodology, hardscape, etc.
 - g. Provide lush landscape setting, which includes the timely maturity of plant materials, use of salvage plant material, strong consideration of water conservation and the needs for shade and/or functional landscaping of the different uses, facilities or space.

E. Master Transportation Systems Plan

1. Performance Standards. The MTSP is to be in compliance with Chapter 47 - Streets, Sidewalks and Public Works Generally of the SRC, and Chapter 5 of the DSPM.
2. Plan Details. The MTSP is to include:
 - a. A TIMA and TIMA Report. Refer to Chapter 5 of the DSPM for the TIMA and TIMA Report requirements.
 - b. In addition to arterial, collector streets and known major driveways, staff may require additional plans and analysis specified in Section 5-1.800 of the DSPM.

F. Master Water Systems Plan

1. Performance Standards. The Master Water Systems Plan is to be in compliance with Chapter 49 - Water, Sewers and Sewage Disposal of the SRC, and Chapter 6 of the DSPM.
2. Plan Details. The Master Water Systems Plan is to be provided in accordance with the Water Master Plan requirements of Chapter 6.

G. Master Wastewater Systems Plan

1. Performance Standards. The Master Wastewater Systems Plan is to be in compliance with Chapter 49 - Water, Sewers and Sewage Disposal of the SRC, and Chapter 7 of the DSPM.
2. Plan Details. The Master Wastewater Systems Plan is to be provided in accordance with the Wastewater Master Plan requirements of Chapter 6.

H. Master Planned Property Plat

1. Performance Standards.
 - a. The Master Planned Property Plat is to be in compliance with Chapter 48 - Land Divisions of the SRC, and Chapter 3 of the DSPM.
 - b. All parcels shall be a minimum thirty-six (36) net acres.
2. Plan Details. The Master Planned Property Plat is to be provided in accordance with the final plat requirements of Chapter 3 of the DSPM.

I. Community Sign District Plan

1. Performance Standards. The Community Sign District Plan is to be in compliance with the Zoning Ordinance, Article VIII. - Sign Requirements of the SRC.
2. Plan Details. The Community Sign District Plan is to include a comprehensive sign program in accordance with the Zoning Ordinance, Article VIII. - Sign Requirements of the SRC.

J. Master Parking Plan

1. Performance Standards. The Master Parking Plan is to be in compliance with the Mixed-Use Shared Parking Program and/or Parking Master Plan requirements of the Zoning Ordinance, Article IX. – Parking and Loading Requirements of the SRC.
2. Plan Details. The Master Parking Plan is to include all information required in the Zoning Ordinance, Article IX. – Parking and Loading Requirements of the SRC for a Mixed-Use Shared Parking Program and/or Parking Master Plan.

MASTER DESIGN CONCEPT PLANS

2-3.300

The Master Design Concept Plan (MDCP) is a plan that establishes common design elements, themes, and materials for phased and complex development proposals. The concept for such master plans was initiated in the early 1980s as Master Environmental Design Concept Plans (MEDCPs) for large scale developments and was later refined in the early 2000s for consideration of complex redevelopment projects.

These master plans establish the locations and character of common elements such as streetscapes, open space corridors, and common facilities as well as design themes and guidelines to be applied to individual projects, buildings, and phases within the proposed development. The DRB approval of a MDCP that contains common elements allows for construction plans to be submitted and permits to be issued. The need for a MDCP is either established through Article VII of the Zoning Ordinance or by stipulations included in the approval of a Zoning District Map Amendment. Development proposals within development projects that have an approved MDCP will need to comply with the provisions of the MDCP or seek to amend the existing MDCP approval. An amendment to an existing MDCP will utilize the DRB approval processes specified in the Zoning Ordinance.

As required by the applicable zoning district, zoning district map amendment stipulations, or by the planning staff, a MDCP may include any of the following components:

- A. Landscaping themes, concepts, materials, and elements for perimeter areas, streetscapes and common amenities;
- B. Outdoor lighting concepts, materials, locations, and applications;
- C. Perimeter wall locations, themes, materials, and concepts;
- D. Pedestrian, cycling, transit, and trail facility locations, standards, materials, connections, and amenities;
- E. Surface drainage facilities location, design concepts, materials, and components;
- F. Scenic corridors, buffer setbacks, desert scenic roadways, vista corridors, and themed streetscape location, design concepts, materials;
- G. Public and common pedestrian plaza and corridor locations, themes, materials, and access connections;
- H. Signage concepts, locations, themes (possibly including a Community Sign District proposal in accordance with the Zoning Ordinance);
- I. Public and private art locations, concepts, and integration with local context;
- J. Phasing, responsible party for construction, and responsible party for maintenance and management for all the components identified above; and
- K. Demonstrate adherence to the city's General Plan, applicable character plans, and various design guidelines.

Chapter 3

LAND DIVISIONS

3

This chapter describes the City of Scottsdale's (city's) processes for all types of land transactions: master planned properties, subdivisions, minor subdivisions, condominiums (condos), and changes to recorded lands. The developer of each land division is expected to construct the public improvements necessary to serve the lots created by the land division, and to assure construction of the public improvements

GENERAL INFORMATION

3-1.000

All master planned developments, subdivisions, minor subdivisions, condos, and amended plats are processed, reviewed and approved through the steps described in Chapter 1 of this manual. The main purpose of these platting processes is to provide for the land division and associated dedications necessary for orderly development. See [Land Divisions Ordinance](#), Chapter 48.

The land division products outlined in this chapter enable parcels, lots, rights-of-way, easements, and tracts to be assigned rights, responsibility and ownership and to become public record through recordation in the Maricopa County Recorder's office. See Section 1-1.403 paragraph H. and I. of this manual.

Standard public improvements such as streets, water, sewer and drainage facilities are required for each land division. Additional public improvements, such as sidewalks, gutters, streetlights, trails, irrigation, parking, recreation areas and amenities are expected where the land division warrants the enhanced level of services. Each land division application will be reviewed against criteria to achieve the optimum services for the lots proposed.

LAND DIVISION TYPES

3-1.100

Land divisions are categorized as subdivisions, minor subdivisions, condos, and amended plats.

SUBDIVISIONS

3-1.200

A property owner wanting to create a subdivision per the Land Divisions Ordinance must file for review and approval of a preliminary and final plat. The preliminary plat (PP) is subject to Development Review Board (DRB) approval. After the PP is approved, improvement plans, and the final plat must be submitted and are subject to approval through final plan review.

The final plat must substantially conform to the PP approved by the DRB and conform to all engineering conditions and requirements of this chapter.

The final plat is subject to City Council approval. Once approved by City Council, the final plat will be recorded with Maricopa County Recorder's Office, see Section 1-1.403 paragraph H and I, to complete the process.

PRELIMINARY PLATS (PP)

3-1.201

A PP shows the approximate location of the street system, the approximate size and configuration of each lot and tract and other information needed by the City of Scottsdale (city) to evaluate the proposed subdivision. See Chapter 2 for site planning standards and considerations. [Application submittal requirements](#) beyond the general requirements listed below are determined in the pre-application meeting.

Plat requirements may result from Zoning Ordinance requirements, such as the Planned Residential Development Zoning District (PRD) and/or the

Environmentally Sensitive Lands (ESL) sections, or from specific zoning stipulations.

The applicant is responsible for meeting all requirements.

The PP must contain, or be accompanied by a concept plan that shows the following information:

A. Site Plan

1. The topography of the area to be subdivided under pre-development conditions. The portrayal of the topography must extend at least 150 feet outside the boundaries of the proposed subdivision. Use contour lines with the contour intervals listed below:
 - a. Outside of the geographic part of COS planned for the ESL zoning district (ESL area): 1-foot interval.
 - b. Within ESL areas: 2-foot intervals or at appropriate intervals as determined by the Planning and Development Services General Manager's designee.
 - c. Within Hillside District (HD) areas: 2-foot intervals.
 - d. Within Hillside Conservation areas: 10-foot intervals.
2. The location and size of all existing easements, rights-of-way and man-made structures or facilities within the boundary of the proposed subdivision and within 150 feet outside the boundaries of the proposed subdivision.
3. All lots, tracts, easements and public rights-of-way planned within the subdivision. Number all lots sequentially and identify all tracts by letter; provide dimensions to indicate the sizes of all lots and tracts. Show required setback lines and proposed construction envelopes (if used or required).
4. Statements describing the existing zoning, gross subdivision area in acres, number of lots, minimum lot size and average lot size. Designate all areas within the plat boundaries not occupied by lots or public streets as tracts. A table is required on the plat showing all lot and tract areas. Each tract, lot, easement and public right-of-way must have a note indicating its approximate area, the planned use and improvement, and the agency responsible for maintenance.
5. Private streets will be dedicated within tracts. A note on the plat will state that the property owners' association is responsible for ownership, operation, maintenance, and liability of the tracts, including maintenance of all appurtenances, i.e. streetlights, signs, landscape, etc.
6. Propose street names based on Maricopa Association of Governments (MAG) adopted convention and policy, subject to city staff approval.
7. If the subdivision has or requires a property owners' association, indicate this on the plat with an appropriate statement as it relates to the responsibilities and requirements as outlined in the CC & Rs – such as the ownership and maintenance of all tracts and private infrastructure.
8. Show proposed locations of multi-use public path/trail easements within the plat boundaries and the connections to existing and proposed path/trail easements. These locations must conform to the city's approved master plan.

9. Corner lots:
 - a. Should be large enough to build a house comparable to others within the subdivision.
 - b. May have public utility easements (PUE) adjacent to the property line in the front yard as well as the yard facing the side street. Fences and walls and other above ground non-utility structures should be located outside of the easement. These easements are private and are not dedicated to the city.
 - c. May need to be larger if they have drainage easements or are located: (i) on adverse terrain, (ii) where substantial cuts or fills occur or (iii) along subdivision perimeters with street frontage.
 - d. Shall conform to Section 2-1.1000 and the [Zoning Ordinance](#)
 10. A native plant submittal for all property containing protected native plant material as identified in Scottsdale Revised Code (SRC) Section 46-105. See the Zoning Ordinance.
 11. Show Natural Area Open Space (NAOS) as required by the Zoning Ordinance for projects subject to Environmentally Sensitive Lands (ESL) requirements. All exempted Hillside District projects shall provide NAOS in accordance with sections 6.1023 and 6.1060 of the [Zoning Ordinance](#).
 - a. NAOS shall be dedicated as an easement or within a common area tract.
 - b. NAOS may be dedicated on the final plat; dedicated at the time of custom lot site plan development; or a combination of both.
 - c. NAOS dedicated as an easement within a common area tract must be maintained by a property owners' association.
 12. If the developer intends to have one recorded plat for the entire subdivision, but plans to construct the improvements in phases, the improvement plans for the entire subdivision are subject to city approval before construction may be phased. The improvement plans for each phase shall indicate any temporary cul-de-sacs, infrastructure lines and valves, etc., and are subject to city approval.
- B. Drainage**
1. Show the street drainage pattern and direction by arrows and indicate those points where concentrated flow is added or removed from the street.
 2. Indicate by arrows the location, direction and amount of flow of all-natural washes and existing or planned man-made drainage channels which flow through, are adjacent to or begin within the proposed subdivision.
 3. Identify areas to be used for surface drainage, storm drainage retention or detention. Sufficient dimensions and other information must be provided to describe the size of the area, the approximate depth and the slope of the sides. These areas will be identified as tracts, which will be owned and maintained by a property owners' association. The developer will dedicate drainage easements over these tracts to the City.
 4. Indicate surface drainage easements which are not in tracts. These easements shall be dedicated to the City but shall be maintained by the property owner(s).
 5. Submit supporting hydrologic and hydraulic calculations with the PP to demonstrate that the easement or tract set aside for drainage is of sufficient

width to carry the peak 100-year flow without endangering life or property outside the easement or tract.

C. Utilities

1. Show the proposed layout of water and sewer lines for the subdivision. Indicate the size of the lines and direction of flow.
2. All other utility easements are private from the association to the utility companies.

FINAL PLATS

A final plat must be in substantial conformance with the approved PP and all applicable City Codes and Ordinances. The applicant is responsible to obtain and fulfill all City Codes and Ordinance requirements whether they are referenced or stated in this manual. The final plat is subject to City Council approval and must be recorded in Maricopa County Recorder's Office. Submit the final plat prepared and sealed by a registered Land Surveyor as per Plat Minimum Standards Appendix 3-1A, and the Final Plat Dedication Example Appendix 3-1C, for review by city staff and City Council. The owner is responsible for preparing, constructing and financing all public improvements associated with the final plat. The owner must have an engineer registered in the State of Arizona prepare a complete set of engineering plans for constructing required improvements. Such plans shall be based on the approved PP, zoning case, DRB and staff approval stipulations. Engineering plans shall be subject to approval by the city prior to recordation of the final plat.

3-1.202

MINOR SUBDIVISIONS

The minor subdivision procedure generally applies to proposals to divide property into five or fewer lots. The standard subdivision procedure will be required for proposals containing complications that cannot be adequately addressed in the minor subdivision procedure and for proposals including a new street.

Minor subdivision plats are subject to General Manager or designee approval. Minor subdivision plats are forwarded to the General Manager for approval after all final plans approvals of both plat and improvement plans have been obtained.

Proposals for minor subdivisions are required to construct applicable public improvements. Proposals for non-residential minor subdivisions are subject to additional site plan review by the DRB.

The minor subdivision plat must conform to all requirements as described in the Plat Minimum Standards, Appendix 3-1A, and the Minor Subdivision Dedication Example, Appendix 3-1D.

3-1.300

MINOR SUBDIVISION REQUIREMENTS

- A. If a new street is created, the project must use the standard subdivision procedure.
- B. All residential lots created must meet the development standards or amended development standards of the applicable zoning district.
- C. The improvement plans must address any staff-imposed stipulations.
- D. All non-residential lots created must meet the DRB's approved development standards.

3-1.301

- E. Minor subdivisions will be required to develop under the standards of the Environmentally Sensitive Lands zoning district as well as the Character Districts.
- F. Major terrain features and washes with a flow of 50 cubic feet per second (cfs) or greater shall remain in their natural state and not be altered, disturbed or diverted unless a wash modification request is approved.
- G. All internal streets will either be public right-of-way or private tracts. If the streets are private tracts, the entrance to the minor subdivision must have controlled access. No easements will be accepted for streets or access.
- H. Before a building permit is issued on any lot in a minor subdivision with private tracts, the applicant must supply satisfactory evidence to the city that: (i) water, sewer and all other required public improvements are provided, (ii) tracts are clearly identified and their purposes specifically noted, (iii) tracts are owned in common by all the lot-owners in the minor subdivision, (iv) lot-owners have authority to collect funds for maintenance of the tracts and (v) lot-owners will maintain the tracts. This evidence may be supplied by Schedule B to a title insurance policy issued on the first lot sold, identifying CC&R's recorded against the minor subdivision. The title insurance policy cannot be more than thirty (30) days old at the time of its submittal.
- I. Staff will require the applicant to provide on-site and off-site public improvements unless a development agreement, approved by City Council, provides for otherwise in form of an in-lieu payment and payment is collected prior to plat recordation.
- J. The applicant for a minor subdivision must post a bond, or provide other acceptable assurance, and execute a covenant to construct to assure the construction of public improvements, subject to approval by the Planning and Development Services General Manager, if plat is to be recorded prior to improvements being constructed.
- K. If facilities are shared in a nonresidential minor subdivision, a shared facilities agreement with all owners of affected lots addressing parking, open space, retention, maintenance, building volume and access is required and submitted during plat review process.

IMPROVEMENT PLANS & FINAL PLATS

After the city staff's notification that the applicant may proceed, the applicant is then ready to submit improvement plans and a proposed final plat. The improvement plans, and final plat must be in conformance with each other. The final plat must conform to all requirements as described in the Plat Minimum Standards, Appendix 3-1A.

The owner is responsible for preparing, constructing and financing all public improvements associated with the final plat. The owner must have an engineer registered in the State of Arizona prepare a complete set of engineering plans for constructing required improvements. The owner must have a Land Surveyor registered in the State of Arizona prepare the final plat. Such plans shall be based on the staff approval stipulations. Final plat may not be recorded until it and the improvement plans have been approved nor until an approved covenant to construct and assurance have been secured.

3-1.302

LIMITATIONS

3-1.303

- A. The approval for a minor subdivision will be allowed once for a maximum of five lots and no further minor subdivisions of the property will be allowed.
- B. Any future subdividing of a minor subdivision will result in the formal (City code Section 48-31) subdivision procedure for all the lots in the minor subdivision. If any public improvement requirements were waived or reduced in the original minor subdivision, they must be constructed if the subdivision is approved.
- C. Anyone attempting to avoid compliance with the state and/or local subdivision laws and regulations will be reported to the Arizona State Department of Real Estate. Examples of transactions that will induce scrutiny include:
 1. Family members, interrelated partnerships, trusts, corporations or other entities acting in concert to divide property, in a piecemeal manner to avoid the application of state and/or local subdivision laws and regulations, especially in a period of less than 5 years.
 2. Any other activity that results in multiple divisions of the same or adjacent property, especially in a period of less than 5 years.

CONDOMINIUM PLATS

3-1.400

Condominium (condo) plats must conform to all city codes and ordinances, DRB and city staff stipulations and Arizona State Department of Real Estate requirements. The applicant is responsible for obtaining and fulfilling all these requirements whether they are referenced or stated in this manual.

Condo plats create a system of individual fee ownership suites/units in a multi-suite/multi-unit structure, combined with joint ownership of common areas of the structure and land. Condominiums plats must conform to all city and state codes and requirements.

CONDO PLAT PROCESS

3-1.401

Condo plats are processed in conjunction with a DRB site plan review procedure.

MODIFICATION OR CHANGE TO A CONDO PLAT PROCESS

3-1.402

A condo plat may also be used to:

- A. Convert an existing structure (apartment building, commercial center, etc.) to a condominium or
 - B. Amend an existing condo
- Both a conversion of an existing structure to a condo and a change to an existing condo, are subject to city staff review to determine conformance with current requirements for all public improvements, such as parking, drainage, utilities, emergency vehicle access, etc. City staff may determine that additional DRB review is required.

To apply, submit a [Condo application](#) and fee to the One Stop Shop.

GUIDELINES FOR REVIEW PROCESS

3-1.403

City staff will use the following guidelines, as examples, to determine whether a conversion of an existing structure to a condo or changes to an existing condo require DRB review. Minor changes are subject to city staff review only. Major changes are more likely to require DRB review. City staff will:

- A. Compare the proposed changes to any previously approved plan and analyze current compliance with the approved plan.
- B. Review the submission to determine the extent of any exterior changes to the structure.
- C. Review the existing access and parking requirements with those that are proposed.
- D. Review the existing drainage facilities and requirements with those that are proposed.
- E. Review the existing emergency and service vehicle access requirements with those that are proposed.
- F. Review the existing intersection and sight distance for vehicles requirements and those that are proposed.

CONDO PLAT SUBMITTAL REQUIREMENTS

3-1.404

The requirements for a Condo Plat are the same as the requirements for a final plat. Additionally:

- A. Condo plat with new construction must be submitted for review at the same time the architectural construction documents are submitted for final plans review.
- B. Existing condo plat with no structure or aesthetic changes may be submitted directly to Development Services by a plan review application.
- C. Identify each individual unit by number and all tracts for common areas by letter. Provide bearings, distances, dimensions and curve data necessary for the complete description of each individual unit or tract. Any area not occupied by an individual unit is common area.
- D. Ensure all suite and unit numbers conform to MAG standards: commercial, 3-digit suite numbers; residential, 4-digit unit numbers. Example for commercial: 1st floor 101, 2nd floor 201, 3rd floor 301.
- E. Verify that each building, suite and unit has a unique identifier, such as Building 1, Unit 1001, or Building A, Suite 101.
- F. Tie floor elevations for each unit to the city's vertical control data. Tie horizontal unit boundaries to the project's property lines by bearing and distance.
- G. Include the following note on the condo plat for private streets. This note is not necessary for private drives provided by easement or Conditions, Covenants, & Restrictions (CC&Rs).
The streets are private streets, maintained by the property owners' association. After this plat is recorded, the city will not accept dedication of the streets to the public to relieve the property owners' association of street maintenance responsibilities.
- H. Include the following note on all condo conversion plats:
The suites, units and buildings of this condo conversion have not been reviewed by the city for compliance with current building code standards.

- I. If a common area is used as a PUE, exclude from said easement the areas that will be used for swimming pools, saunas or other permanent structures (other than individual units). Blanket easements are generally unacceptable because they overlap areas which permit construction that may conflict with the easement.
- J. Include a dedication block, a ratification block and acknowledgement, as shown in Appendix 3-1E.
- K. Submit a draft copy of the CCRs or Declaration of Condo during the review process if available else, plat language limiting city responsibilities will be required.
- L. Condo plats will not be recorded prior to improvement plan approval.

CHANGES TO A RECORDED LAND DIVISION

3-1.500

Changes to recorded plats are subject to the city's approval. The city staff will meet with the applicant to review the extent and effect of the changes and advise the applicant which procedure is appropriate to make the changes.

An owner/developer may want to make changes to an approved, recorded land division. Different kinds of changes require different kinds of procedures. The nature and complexity of the change will dictate which procedure applies and is generally related to the number, size, location, zoning, recordation and history of the affected lots. The general parameters of each kind of change are set forth below. However, each change is unique in its effects, so the general rules may not apply in every case. The city staff will determine the effect of each change based on the general parameters. The owner/developer may appeal the city staff's decision of which procedure applies as set forth in the Land Divisions Ordinance.

The change may be subject to revisions in applicable ordinances, codes, plans, regulations and policies enacted since the original plat was recorded.

COMPLETE REVISION (MAJOR CHANGES)

3-1.501

Staff will determine that a complete revision is required if one of the following considerations is evident:

A. All Land Divisions

1. Time limits have expired on previous stages in the land division procedure.
2. Public streets are proposed to become private streets, or private streets are proposed to become public streets.
3. The change to the land division substantially changes the existing character of all or part of the original land division. For example, if the new lots are substantially different in size and/or configuration, and/or the new construction is substantially different in size, design and/or cost from the original land division, a change of character is taking place.
4. The change affects the perimeter of the land division.
5. The changes are so significant that the original land division is no longer viable from planning and economic considerations.

B. Subdivisions

Major changes are proposed to zoning, lot size, number of lots, tracts, or common area tracts or facilities. Any change that is so significant that the final plat can no longer be considered in substantial conformance to the approved PP, as

determined by city staff, requires a complete revision. A complete revision includes all the procedures to obtain approval of a PP and a final plat.

C. Minor Subdivisions

Major changes are proposed to zoning, lot size, number of lots, tracts, or common area tracts or facilities, so that the changes no longer conform to the approval of the minor subdivision. The complete revision would start with a new pre-application and conference.

D. Condos

Major changes are proposed to property boundaries, number of units/suites, tracts, common areas or common facilities, so that the changes no longer conform to the original city staff or DRB approval.

PARTIAL REVISION

3-1.502

The owner shall meet with city staff to determine whether a modification to a recorded land division is subject to council or city action:

A. Plat modifications requiring council action include:

1. Modifications to a recorded final plat for a subdivision
2. Modifications to a master planned property plat approved in conjunction with a zoning map amendment request;

B. Plat modifications eligible for staff approval include:

1. In minor subdivisions: Movement of property lines in substantial conformance with the approved plat.
2. In condos:
 - a. Revisions to a limited portion of a condo plat such as adding or making minor changes to demising lines, parking spaces and common areas in substantial conformance with city staff or DRB approval.
 - b. Removal of Condo Declarant: A "Certificate of Termination of Condominium Declaration" shall be prepared by the applicant and recorded by the city with a plat to create a single lot.

LAND ASSEMBLAGE

3-1.600

When two or more existing lots or tracts of land are combined into fewer lots or tracts the process requires both city approval and plan review. To apply, submit a [Land Assemblage application](#) and fee to the One Stop Shop.

A. Review Process

The Planning and Development Services Department staff will review the application to determine whether the proposed land assemblage meets the appropriate criteria for staff approval. The application is reviewed for compliance with city code, zoning, building code, archeology, engineering and transportation requirements.

The land assemblage approval process involves the following steps:

1. If the application meets the criteria for staff approval without further information, staff will advise the applicant of required stipulations, issue a staff approval and provide a plan submittal check list to submit the land assemblage plat.

2. If the application requires further information, the project plat coordinator will advise the applicant to provide specific additional information.
3. If the application does not meet the criteria for staff approval, the project coordinator will inform the applicant of possible alternate methods of approval for the proposed project.
4. Final plan review of the land assemblage plat will check for compliance with any stipulations and plat standard requirements, see Appendix 3-1A.
5. A land assemblage plat is recorded by the city at the Maricopa County Recorder's Office.

B. **Evaluation Process**

The Planning and Development Services Department staff will review the proposed land assemblage application to determine whether it can be approved by staff based on the following criteria:

1. Access to the assembled lot(s) remains in substantially the same location as before the assemblage.
2. Utility service to the assembled lot(s) remains in substantially the same location as before the assemblage.
3. Application for the land assemblage is not made in consideration of the amount or location of NAOS on the property or surrounding lots.
4. Use of the assembled lot(s) is likely to preclude further subdivision or assemblage of the lots.
5. The impact of the land assemblage on surrounding lots is minimal.
6. The impact of the land assemblage on the character of any underlying or surrounding subdivision is minimal.

PUBLIC IMPROVEMENTS

3-1.700

The owner is responsible for planning, constructing and financing all public improvements associated with land divisions (dividing, assembling and platting property) and land development. These public improvements must be completed and accepted before the city will issue a certificate of occupancy (C of O). The owner must have an engineer registered in the State of Arizona prepare a complete set of improvement plans for constructing required improvements. Such plans shall be based on the approved PP, zoning case, DRB and/or staff approval stipulations. The owner must prepare these plans in conjunction and in conformance with the final plat. Improvement plans shall be subject to city approval prior to recordation of the final plat. Refer to Section 1-2.000 of this manual for submittal requirements.

INFRASTRUCTURE REQUIREMENTS

3-1.701

A. **Water Supply**

The owner shall provide each lot with safe, pure and potable water in sufficient volume and pressure for domestic use and fire protection, in accordance with city standards; see Section 6-1.000 of this manual. The owner shall install fire hydrants in accordance with current city standards at locations designated by the city. These requirements are key elements that must be completed before any building permit for a structure is issued.

B. Public Sewer

The owner shall install sewage disposal facilities to serve each lot, see Section 7-1.000 of this manual and SRC Chapter 49, and be subject to the following:

1. The owner shall install public sanitary sewers (SS) in areas which are reasonably accessible to an existing sewer system and shall be constructed to plans, profiles and specifications approved by the Maricopa County Environmental Services Department and the city.
2. In areas where public SS are not reasonably accessible, but where the future servicing/owning agency agrees to effect temporary disposal of sewage, the sub divider shall plan and construct dry sewers within, and for, the subdivision for connection with a future public system.
3. Individual systems may be constructed only in areas not reasonably accessible to a public sewer system and then only when the following conditions are met to the satisfaction of the Maricopa County Environmental Services Department:
 - a. Adequate soil absorptivity.
 - b. Construction complies with approved standards.
 - c. Location of septic tank and seepage pits or leach lines or disposal beds in relation to property lines and buildings and water supply wells and lines are acceptable. Location shall be such that efficient and economical connection can be made to a future public sewer.

C. Stormwater

The owner shall provide facilities for stormwater disposal. The type, extent, locations and capacity of drainage facilities shall be in accordance with city standards, refer to Chapter 4 of this manual.

D. Streets and Alleys

The owner shall grade and construct all streets and alleys within the land division to cross sections, grades and standards approved by the city, refer to Chapter 5 of this manual.

E. Curbing

Where streets are to be paved, the owner shall install curb in accordance with approved city standards, see Section 5-3.000.

F. Sidewalks

Concrete sidewalks are required on both sides of streets and must be constructed to a width, line and grade in accordance with approved city standards; refer to Chapter 5 and Chapter 12 of this manual. Where density of development is low or where for other reasons the installation of sidewalks is not considered necessary, city staff may recommend that the requirement of one or both sidewalks be waived.

G. Street Names and Signs

The owner shall propose street names subject to city staff approval and based on MAG adopted convention and policy. The owner shall place street name signs at all street intersections in conformance with city standards. Street name signs in subdivisions must conform to the COS Supplement to MAG Uniform Standard Specifications for Public Works.

H. Streetlights

The owner shall design and install streetlights in accordance with city standards, refer to Section 2-1.1103 of this manual.

I. Benchmarks

Submittals are to be based on North America Vertical Datum of 1988 (NAVD 88) and meet the Federal Emergency Management Agency (FEMA) Benchmark Maintenance (BMM) criteria. See the criteria defined within the Coordinator's Manual of the National Flood Insurance Program Community Rating System. Use the MCDOT benchmark system in accordance with the BMM criteria.

J. Monuments

The owner shall install permanent monuments in accordance with city standards at all corners, angle points and point of curves and at all street intersections.

1. Street Monuments

These monuments represent section lines and property boundaries. When street monuments are perpetuated or set, it must be performed consistent with the Arizona Boundary Survey Minimum Standards.

2. Procedure for perpetuating street monuments:

Prior to removing a monument, a minimum of three reference marks are to be set with the identifier "RM" and the land surveyors registration number in the manner defined by the Arizona Boundary Survey Minimum Standards and Arizona Administrative Code R4-30-306.

Horizontal control shall establish a basis of bearings, ties between the reference marks and the existing street monument, and their state plane coordinates.

Vertical control shall be established in NAVD 88 elevations format on the street monument and each reference mark.

A registered land surveyor shall prepare and submit to the city for review and approval. A Results of Survey map shall follow the applicable Plat Minimum Standards in Appendix 3-1A and the Horizontal & Vertical control information.

3. Procedure for setting street monuments:

When street monuments are being set based on approved Results of Survey map, then an amendment to that map showing the horizontal & vertical control, and monument character type set, shall be submitted to the city for approval and recordation.

K. Lot Corners

The owner shall set iron pipe or round reinforced steel bars not less than one-half inch in diameter at all corners, angle points and points of curve for each lot within the subdivision. (Corners must be set prior to the transition to the warranty period).

L. Electric, Telephone and Dry Utility Lines

1. The owner shall install underground electric lines (except those of greater than twelve thousand five hundred (12,500) KVA capacity) and telephone, cable TV and telecommunication lines necessary to serve the land division, as well as any such existing lines along the frontage or contained within the property.

The City Council may find undergrounding impractical due to subsurface soil conditions.

2. The owner shall be responsible for compliance with the requirements of this section and shall make the necessary arrangements with each of the public utility companies involved for the installation of underground facilities. Letters from each of the public utility companies indicating that the arrangements have been made shall be submitted to the city at the time the final subdivision plat is filed.

M. Refuse Containers.

All solid waste collection methods for both commercial and residential services are subject to the approval of the Solid Waste Management Director or designee. The developer or sub divider must pay for residential refuse and recycling containers. The city will deliver containers at the initial occupant's request.

PROPORTIONATE SHARE

3-1.702

- A. The on-site and off-site public improvements shall be proportional to the relative impact of the proposed development and shall be in character with existing and anticipated development adjacent to the proposed development.
- B. The following factors will be considered in determining what public improvements are proportional:
 1. Proximity of the proposed development to existing development and existing public improvements
 2. Applicable city-adopted general and local plans
 3. Number and size of proposed lots
 4. physical and topographical restraints/constraints
 5. Drainage constraints
 6. Project specific impact analysis/design reports
- C. Additional bases for determining the engineering standards for proportional public improvements are existing city code requirements and policies, including but not limited to:
 1. Minimum public improvement requirements for single family dwellings for public health and safety
 2. Minimum water and sewer requirements for public health and safety
 3. Street improvements in Chapter 47 of the SRC
 4. Minimum design standards as set forth in this manual

ASSURANCE OF CONSTRUCTION

3-1.800

Assurance of construction is required for all improvements associated with land divisions (dividing, assembling, platting property, survey boundary monuments and street monuments) and land development. An assurance of construction is a financial security that guarantees completion of designated public improvements according to approved plans and is a precondition for recordation of a final plat. The owner is responsible for providing the assurance of construction to the city.

If the owner defaults on constructing improvements, the city may choose, among other options, to construct, maintain or remove the improvements in whole or in part;

bring action to enforce the owner's obligations; or otherwise mitigate the owner's failure to complete the public improvements.

ASSURANCE PROCESS

3-1.801

The form of assurance will be established during final plan review. The owner shall select the means of assurance, subject to staff approval, and submit the Engineer's Estimate of Construction Costs for review and approval.

At the time of final plan approval, the owner must submit the Covenant to Construct Public Improvements with the executed bond, letter of credit, or cash deposit.

Assurances must be in place prior to the recording of the plat.

TYPES OF ASSURANCE

3-1.802

The types of assurances acceptable to the city are outlined below. The owner must use the [appropriate city forms](#) when providing assurance of construction.

A. Corporate Surety Bond

The corporate surety bond involves an agreement between the owner and a bond company to guarantee to the city that improvements will be made by the owner as planned and within a specified time frame. The surety must be a corporation authorized to transact surety business in the State of Arizona. The surety must have an AM Best rating of at least A+ VII or be on the latest US Treasury Department Listing of Approved Sureties.

The owner provides the Public Improvement Construction Bond form to the city in an amount equal to the cost of the required improvements as identified on the Engineer's Estimate of Construction Costs form.

B. Cash Deposits

The owner provides the Public Improvement Cash Deposit Agreement to the city with either cash or a cashier's check in the amount equal to the cost of the required improvements identified on the Engineer's Estimate of Construction Costs.

C. Letter of Credit

The owner acquires a letter from a bank that complies with the city's Standards for Letter of Credit. The letter must specify the amount equal to cost of the proposed improvements as identified on the Engineer's Estimate of Construction Costs.

ASSURANCE REDUCTION FOR WARRANTY PERIOD

3-1.803

At the developer's request, the city will complete the final inspection of improvements. Prior to staff taking the final acceptance of improvements to the city for approval, the work must have passed final inspection, Mylar as-built plans along with a compact disc (CD) in Portable Document Format (PDF) of the as-built drawings must be submitted to the City, and the city must have a financial assurance in place for 10 percent of the total cost of the improvements. The 10 percent financial assurance must be in place for a period of one (1) year from the date of final acceptance of the improvements.

This assurance, held during the one-year warranty period, may result from the reduction of the existing subdivision performance bond, irrevocable letter of credit, or

cash assurance previously paid, or the developer may submit a new warranty bond, irrevocable letter of credit, or cash solely for the warranty purpose.

After the work has passed final inspection, the city has received the Mylar set and compact disk (CD) of the as-builts, and the 10 percent assurance is in place, staff will make a recommendation to the Development Engineering Manager to approve the final acceptance of improvements. If the developer opted to submit a new warranty bond, irrevocable letter of credit or cash, the city will release the initial assurance provided for construction after the city approves the final acceptance of improvements.

During the one-year warranty period, the developer is responsible for repair work for any of the public improvements. City staff will periodically inspect the public improvements and will notify the developer of the necessary repair work. The developer is responsible for having the repair work completed prior to the end of the warranty period. Upon successful completion of the warranty period and successful repair of any necessary warranty items, the remainder of the assurances retained by the city will be released.

PLAT REQUIREMENTS

PLAT SUBMITTALS

Real property plat submittals must comply with applicable policies and standards. This includes but is not restricted to the Arizona Boundary Survey Minimum Standards and the [statutes](#) governing the Arizona State Board of Technical.

All submittals requiring or referring to elevation data must use the NAVD 88.

PLATS

A subdivision survey is to be considered an original survey. A relocation of boundary lines that were marked on the ground during the original survey is a boundary retracement survey.

All platting (mapping) to create new or different parcels, tracts, lots, or units of land for sale, lease, or public use must be done in accordance with the standards set forth in the laws of the United States, state of Arizona, county of Maricopa, and the city. Land surveying submittals will comply with the published rules and standards as set forth.

A. LAND SURVEYING STANDARDS

The land surveyor shall comply with the following standards:

1. The Public Land Survey System established by the General Land Office and currently administered by the Bureau of Land Management, when performing any land boundary survey.
2. The Arizona Revised Statutes regarding land surveying and mapping, together with the "Minimum Standards for Arizona Land Boundary Surveys" (effective February 2002 by the State of Arizona Board of Technical Registration or as subsequently revised), administered by the Board of Technical Registration.
3. Boundary survey retracements are to be conducted in accordance with: Brown's Boundary Control and Legal Principles, Evidence and Procedures for Boundary Location, and Writing Legal Descriptions in Conjunction with Survey Control.
4. The Maricopa County Recorder requirements for recording standards.
5. The city's minimum standards for platting, with proper research, field examination, measurements, analysis, calculation and presentation.

B. SUBMITTAL REQUIREMENTS

The applicant must submit:

1. An American Land Title Association (ALTA)/National Society of Professional Surveyors (NSPS) Land Title Survey Plat, and Table A items; 1, 2, 4, 6, 7, 8, 9, 11, 16 reflecting current conditions that is based on a current record of survey within six (6) months of the submittal date.
2. Survey field notes, raw data, and coordinate files (electronically) from the actual field survey conducted by the surveyor submitting the plat.
3. Provide list of Recorded Documents used/researched on the Plat.
4. The closure and area calculations for the subject property, lots, tracts, parcels, and easements being created or of record resulting from a land division.
5. A commitment for title insurance as required in paragraph G of Section 1-1.403.

PLAT REQUIREMENTS

6. A fee simple warranty deed with the boundary monuments set and called out for all parcels to be deeded to the city for public purposes.
7. For projects requiring dedication of NAOS, a detailed worksheet and graphic depicting the required and provided amounts of NAOS being dedicated for the subdivision.
8. A separate document at the time of final plat submittal identifying how NAOS will be secured prior to and during construction to ensure that those areas will remain undisturbed.
9. Certified copies of resolutions showing who is authorized to sign a dedication on behalf of a lender or other interested person who must ratify the dedication.
10. When terminating a condo, a Certificate of Termination of Condominium Declaration.

C. PLAT REQUIREMENTS AND STANDARDS OF PRACTICE

The surveyor shall research maps, plats, and other public agency records that disclose evidence of monuments pertaining to the survey; and review adjoining deeds for evidence of seniority or conflicts. The plat must contain the following information:

1. Monuments, legal or physical, are to be described with certainty. Boundary monuments are to have full character descriptions, i.e. all stamped information, height above or depth below the natural ground surface, and the source of its identity. The boundary survey is to be composed of monuments placed on the ground by the surveyor, and plats are prepared to describe the boundary survey.
2. A boundary retracement survey must provide field measured survey ties from the boundary lines to evidence of occupation, i.e. fences, walls, buildings, legal monuments and such. The boundary retracement survey shall provide field measured ties to adjoining boundaries by recovering physical or legal evidence, define senior rights and completely address calls made in the deed (explicit or implied).
3. The subject property boundary line should be the heaviest solid line. The boundary is defined in title report legal description. Include easements in the gross subject property area.
4. List all registered land surveyor license numbers that are recovered and associate to the respected recorded document.
5. Use written evidence of title in the form of a deed and a title commitment. Research of maps, plats, public agency records that disclose evidence of monuments pertaining to the survey. Determine by reviewing deeds on adjoining properties for evidence of seniority or conflicts.
6. All easements that appear in title report, citing width, dimensions, and recorded instrument number.
7. Any easements that may appear on the Patent Deed in Small Tract Act areas. Also known as "GLO Easements" and do not always appear in title report. See Section 1-1.304 paragraph E.
8. Plat name (title caption), right-of-way lines, courses, lengths, width of all public streets, alleys, crosswalks and utility easements; points of tangency and central

PLAT REQUIREMENTS

- angles of all curvilinear streets and alleys; radii of all rounded street line intersections.
9. Curve geometry shall include; radius, delta, arc length, and chord bearings
 10. Location of all physical encroachments upon the boundaries of the subject property.
 11. Any exception parcel within the plat boundaries.
 12. All drainage ways, as designated by the city, which shall be dedicated to the city.
 13. All existing improvements that are affected by zoning district restrictions with distances from any property line.
 14. Existing well, septic tank and disposal site, and the proposed distance from any property line and structures.
 15. Vicinity Map.
 16. All adjacent property including, names of property owners, assessor parcel numbers, roadways with names and recording information.
 17. Area, in square feet, and dimensions of each new lot with lot number.
 18. Basis of bearings, and all measured and recorded distances.
 19. Complete legal description as appears in the current title report for subject property.
 20. List of all previous plats, maps, and any other documents used as a reference for the plat preparation.
 21. North arrow and scale.
 22. Significant land features.
 23. Dedication statement.
 24. Confirmation by any lender or other interested person who holds a deed of trust, mortgage or property interest agreement that encumbers the subject property. The confirmation must include the book and page where the lien is recorded, and the date of the lien.
 25. Owner Warrantee Statement.
 26. Location and all dimensions of all lots, tracts, parcels, streets and easements planned within the subdivision. Number all lots sequentially and identify all tracts by letter.
 27. A table showing the square footage for all lots.
 28. The approved street names.
 29. Private streets as separate tracts. Easements for private streets are unacceptable.
 30. The following note for plats with private streets:
 31. [Owner's name and corporate status], owner, Grantor, declares the private streets shown hereon as Tract -- as private access ways, not dedicated to the public for its use except as expressly stated hereon. The Grantor and its successors shall maintain, repair and replace the private streets. The city has no obligation to maintain, repair and replace the private streets arising from this plat. Private streets require controlled access to the public street system.
 32. All boundary monuments are to be set by the land surveyor of record prior to the recording of the plat.

PLAT REQUIREMENTS

33. When practical to do so, interior property corners & streets shall be monumented as soon as completion of the infrastructure and improvements and verified by the city Inspection Services. If such monuments should differ from the type described on the plat, a record of survey shall be recorded showing these differences. All monuments set shall be under the direct supervision of the registrant of record. If for any reason the registrant of record is not available to supervise the setting of the monuments, after the recording of the final plat, the replacement registrant shall set the monuments with their registration number and a record of survey recorded in accordance with the city Design Standards and Policy Manual.
34. Approval block for final plat as shown in Appendix 3-1C.
35. A note stating that: "Affidavits of correction or amendment type letters concerning this plat are not valid. There will be no revisions to this plat without the Plat Coordinators approval"
The maintenance of landscaping within the public right-of-way to back of curb shall be the responsibility of the community association or abutting property owner.

LAND SURVEYORS CERTIFICATION

This is to certify that

1. I am a land surveyor registered to practice in Arizona
2. This plat was made under my direction
3. This plat meets the "Minimum Standards for Arizona Land Boundary Surveys"
4. The survey and division of the subject property described and platted hereon were made during the month of _____, 20_____
5. The survey is true and complete as shown
6. All monuments as shown exist and their positions are correctly shown. Said monuments are sufficient to enable the survey to be retraced.

Name

Registered Land Surveyor Registration No.



COVER SHEET

The cover sheet shall show:

1. Owner/Developer name, address, phone number.
2. Engineer/Surveyor name, address, phone number.
3. Existing zoning, number of acres.
4. Sheet number/index.
5. Owner Signature Block and Acknowledgement.
6. Registered land surveyor seal.
7. Legend.
8. All case numbers and plan checks along the right-hand border.

Required sheet notes:

PLAT REQUIREMENTS

- A. **If in a city water service area:**
The development is on the city water system which has a certification of assured water supply.
- B. **If not in a city water service area:**
A certificate of assured water supply has been submitted to the city for this development.
- C. **Subject property within a 2-mile vicinity of the Scottsdale Airport:**
This property lies within close proximity to the Scottsdale Airport ("the Airport"), which is located between Frank Lloyd Wright Boulevard on the north, Pima Road on the east, Thunderbird Road on the south and Scottsdale Road on the west. The Airport is a general aviation reliever/commercial service airport for Scottsdale/Phoenix area.

PLAN SHEETS

All sheets shall show in block form in the lower right-hand corner of the plat the following information:

- A. The name, address, and telephone number of the individual or agency that prepared the plat.
- B. Name of the subdivision, condo or map of dedication.
- C. Date prepared and job number.
- D. Scale.
- E. Sheet ___ of ___ sheets.
- F. Land surveyor's seal.

PLAT DEDICATION LANGUAGE

[Owner's name and corporate status], owner, hereby subdivides [general property description], Maricopa County, Arizona, under the name "[subdivision name]" as shown on this Final Plat. This Plat sets forth the location and gives the dimensions of the lots, tracts, streets and easements constituting the subdivision. Each lot, tract, street and easement shall be known by the number, letter, name or description given each respectively on this Plat. The easements are dedicated for the purposes, and subject to the conditions, stated.

PUBLIC STREETS

[Owner's name and corporate status], owner, Grantor, dedicates, in fee, to the City of Scottsdale, an Arizona municipal corporation, Grantee, the public streets as shown hereon. See SRC, Chapter 47, as amended, for Grantor's maintenance obligations. Without limitation, Grantee may (1) grade, fill, drain, pave, construct, operate, maintain, repair, and rebuild roads, highways, utility lines, pipes and related facilities, with bridges, culverts, drainage ways, ramps, sidewalks, curbs, gutters, cuts and other related improvements, and (2) cut and trim branches, trees and growth that extend into the improvements, to prevent interference with the efficient maintenance and operation of the improvements.

PRIVATE STREETS

[Owner's name and corporate status], owner, Grantor, declares the private streets shown hereon as Tract -- as private access ways, not dedicated to the public for its use except as expressly stated hereon. The Grantor and its successors shall maintain, repair and replace the private streets. The city has no obligation to maintain, repair and replace the private streets arising from this plat.

EASEMENTS

[Owner's name and corporate status], owner, Grantor, dedicates to the City of Scottsdale, an Arizona municipal corporation, Grantee:

A. Avigation:

A perpetual, non-exclusive easement shown hereon, upon, over and across the property on this plat, for the right of flight for aircraft in the airspace above the property.

1. "Aircraft" means any manned or unmanned device that flies.
2. Without limitation, the right of flight includes the right to operate aircraft over and near the Property, and cause any noise, vibration, fumes, light, exhaust, odors, fuel vapor particles, electronic interference, dust, annoyances, nuisances, emissions, and any other effects relating to operating aircraft (collectively "Aircraft Effects").
3. All Aircraft Effects are included within the scope of the easement, including without limitation those that reach or affect the Property or improvements to the Property, interfere with other uses of the Property, annoy users of the Property, and are caused or made worse by any changes in the following:
 - a. The size, number, method of propulsion, weight, noisiness, design, fuel, category, type or other characteristics of aircraft, and in any aircraft practices, laws, rules, policies, circumstances, customs, protocols or procedures.

PLAT DEDICATION LANGUAGE

- b. The airport size, orientation, configuration, location, runway length, improvements or other characteristics, and in any airport practices, laws, rules, policies, circumstances, customs, protocols or procedures.
 - c. The flight paths, flight frequency, flight timing, airport operations, climbing and descending, altitudes, takeoff and landing, air traffic control, and in any related aircraft and airport practices, laws, rules, policies, circumstances, customs, protocols or procedures.
 - d. Grantor's or others' personal perceptions of Aircraft Effects or sensitivity to Aircraft Effects.
4. Grantor shall not cause or allow the Property to be used to discharge fumes; smoke; dust; or electronic, light, laser or other emissions, which may obstruct visibility or adversely affect or interfere with the operation of aircraft or any navigational facilities. No building, mast, tree, vegetation, or other thing upon the Property shall exceed Federal Aviation Administration approved height restrictions.
 5. Grantor has been advised and understands that:
 - a. All or a portion of the Property is located in a noise-influence area.
 - b. Aircraft Effects might be annoying to users of the Property and might interfere with the unrestricted use and enjoyment of the Property.
 - c. Aircraft Effects will likely increase over time.
 6. Grantor waives all rights and claims that Grantor may ever have against, and agrees not to sue, Grantee regarding Aircraft Effects. Grantor makes its waivers and agreements for itself, its successors and assigns, in favor of Grantee, and all Grantee's officers, officials, employees, agents, lessees

B. Drainage and Flood Control (DFC):

A perpetual, non-exclusive easement shown hereon upon, over, under and across the property on this plat, for drainage and flood control and all related purposes, including without limitation, construction, maintenance, operation, replacement, and repair of levees, dikes, dams, stormwater storage basins, storm drains (SD), channels, improvements, washes, watercourses and other drainage or flood control facilities (collectively, "drainage facilities"), subject to the following:

1. Grantor is responsible for all drainage facilities on the Property. Drainage facilities on the Property might not be obvious. Lack of awareness of drainage facilities does not excuse failure to perform the requirements of this document.
2. Grantor shall not construct, obstruct or alter any drainage facilities on the Property without Grantee's prior written consent.
3. At Grantor's expense, Grantor shall maintain drainage facilities in good condition; replace and repair drainage facilities as necessary to maintain their flood carrying or storage capacity; prevent erosion; and prevent any refuse, debris, sediment, vegetation, or other obstruction from accumulating in drainage facilities. Grantee is not obligated to perform any such work.
4. If, in Grantee's opinion, Grantor fails to do such work, then Grantee may do the work at Grantor's expense. In addition to Grantee's other remedies, the cost of the work shall be secured by a lien that Grantor hereby grants against the Property, with interest at the annual rate of eight percent (8%).

PLAT DEDICATION LANGUAGE

5. Grantor shall indemnify, defend and hold Grantee harmless against Grantor's failure to perform under this document.

C. Emergency and Service Access (ESA):

A perpetual, non-exclusive easement shown hereon upon, over, under and across the property on this plat, for access for emergency, public safety, refuse collection, utility, and other service personnel and vehicles and for the right to construct, operate, use, maintain, repair and replace improvements related to access as city deems necessary for access purposes.

D. Natural Area Open Space, including Restored Desert (NAOS):

A perpetual, non-exclusive easement shown hereon upon, over, under and across the property on this plat, for natural desert open space preservation as follows:

1. Grantor shall not use the Property in any way inconsistent with the preservation of the easement in its undisturbed condition as permanent natural desert open space.
2. Grantor shall not grade, grub or excavate the easement, or construct any structure on the easement, except as approved by Grantee, in writing, specifically referring to this easement.
3. Grantor shall restore the easement in accordance with plans approved by Grantee, if the easement is disturbed. The restored desert shall be preserved as desert open space.
4. Grantee may enjoin any violation of this easement. Grantee may enter the Property to enforce this easement. However, this easement does not create public access to the Property.
5. Mentioning remedies in this easement does not limit Grantee's right to other remedies.

E. Public Non-Motorized Access (PNMA):

A perpetual, non-exclusive easement shown hereon, upon, over, under and across the property on this plat, for all forms of non-motorized transportation together with motorized emergency, law enforcement, and service vehicles, and for construction, operation, use, maintenance, repair, modification and replacement from time to time of improvements related thereto. See SRC, Chapter 47, as amended, for maintenance obligations.

F. Public Motorized Access (PMA):

A perpetual, non-exclusive easement shown hereon upon, over, under and across the property on this plat, for all manner of pedestrian and motorized and non-motorized vehicular access, and for construction, operation, use, maintenance, repair, modification and replacement from time to time of improvements related thereto.

G. Public Utility (PU):

A perpetual, non-exclusive easement shown hereon upon, over, under and across the property on this plat, for electricity, telecommunications, data transmission, and all other manner of utilities, and for construction, operation, use, maintenance, repair, and replacement of improvements related to utilities. In the easement, Grantor shall not place or allow any (1) trees, hedges, shrubs or other plants which

PLAT DEDICATION LANGUAGE

can grow larger than 18 inches tall, or (2) hardscape, swimming pools, sheds or other vertical or horizontal structures.

H. Scenic Corridor (SC):

A perpetual, non-exclusive easement shown hereon upon, over, under and across the property on this plat, to preserve permanent desert open space. However, Grantor may install vegetation, driveways, signage, underground private utilities and other improvements in the easement in accordance with plans approved by Grantee. Grantor shall maintain the Property, including any improvements, free of debris, in a safe and natural condition.

Grantee may enjoin any violation of this easement. Grantee may enter the Property to enforce this easement. However, this easement does not create public access to the Property. Mentioning remedies in this easement does not limit Grantee's right to other remedies.

I. Sight Distance(SD):

A perpetual, non-exclusive easement shown hereon upon, over, under and across the property on this plat, to preserve an area free of obstructions to enhance traffic safety visibility. In the easement, Grantor shall not place or allow any buildings, walls, trees, structures, screens or other obstructions from 18 to 96 inches high above the elevation of the adjacent street. However, the Grantee may allow poles or tree trunks that Grantee determines, in writing, do not adversely affect traffic safety visibility.

J. Vehicular Non-Access (VNA):

A perpetual, non-exclusive easement shown hereon upon, over, under and across the property on this plat, to prohibit all use of motor vehicles upon the easement. Grantor shall not install driveways or other means of vehicular access upon the easement. Grantor shall maintain the easement, including any improvements, in a neat, safe and clean condition.

Grantee may enjoin any violation of this easement. Grantee may enter the Property to enforce this easement. However, this easement does not create public access to the Property. Mentioning remedies in this easement does not limit Grantee's right to other remedies.

K. Water and Sewer Facilities (WSF):

A perpetual, non-exclusive easement shown hereon upon, over, under and across the property on this plat for water and sewer pipes and other related facilities, and for construction, operation, use, maintenance, repair, modification and replacement of pipes and other related facilities.

L. Public Transit Facilities and Access (PTFA):

A perpetual, non-exclusive easement shown hereon upon, under and across the property, to preserve permanent all forms of public transit, public transit related improvements together with emergency, law enforcement, and service vehicles, and for construction, operation, use, maintenance, repair, modification and replacement from time to time of improvements related thereto. Grantee shall have the right to construct, install, operate, maintain, repair, replace and remove, transit shelters, transit bays (or turnout) and all other appurtenances and fixtures connected therewith, in, upon, over, under, and across the real property.

CITY APPROVAL EXAMPLE

CITY OF SCOTTSDALE COUNCIL PLAT APPROVAL	
Approved by the City Council, Scottsdale, Arizona this the ____ day of _____, 20__.	
By: _____:	
Mayor	
ATTEST By: _____	
This plat has been reviewed for compliance with the City of Scottsdale’s Design Standards and Policy Manual specifications.	
By: _____	_____
Chief Development Officer	Date
This subdivision has been reviewed for compliance with the development standards of the City of Scottsdale’s Development Review Board (DRB) Case No. ____, and Zoning Case(s) No. ____, and all case related stipulations.	
By: _____	_____
Development Engineering Manager	Date

CITY OF SCOTTSDALE STAFF PLAT APPROVAL	
This plat has been reviewed for compliance with the City of Scottsdale’s Design Standards and Policy Manual specifications.	
By: _____	_____
Chief Development Officer	Date
This subdivision has been reviewed for compliance with the development standards of the City of Scottsdale’s Development Review Board (DRB) Case No. ____, and Zoning Case(s) No. ____, and all case related stipulations.	
By: _____	_____
Development Engineering Manager	Date

Chapter 4

GRADING & DRAINAGE

4

This chapter provides guidance for complying with specific federal, state, county, and city regulations applicable to floodplain management, water quality, and stormwater management. It presents guidance for preparing drainage reports and grading and drainage plans using the design standards and methodologies adopted by the City of Scottsdale (city), the Flood Control District of Maricopa County (FCDMC), the Arizona Department of Water Resources (ADWR), and the Federal Emergency Management Agency.

GENERAL INFORMATION

4-1.000

A. **This chapter:**

1. Administers Chapter 37, the Stormwater and Floodplain Management ordinance, of the Scottsdale Revised Code (SRC).
2. Provides guidance for complying with federal, state, county and city regulations applicable to floodplain management, water quality and stormwater management.
3. Outlines requirements for preparing drainage reports and grading and drainage plans.

B. **Intent.**

This chapter is intended to provide guidance for designing meaningful flood protection, but such protection can be challenging because the natural grade has already been disturbed, existing development may constrain drainage options, or other reasons. In such cases, the Floodplain Administrator may require different or additional flood protections to:

1. Avoid any increased danger or damage to persons or property, and
2. Meet the general intent and purposes of the regulations.

GOVERNMENT AUTHORITIES

4-1.001

A. **FEDERAL AUTHORITIES**

1. Federal Emergency Management Agency (FEMA)
2. United States Environmental Protection Agency (EPA)
3. The United States Army Corps of Engineers (USACE)
4. The United States Department of Agriculture (USDA) Natural Resources Conservation Services

B. **STATE AUTHORITIES**

1. AZ Department of Water Resources (ADWR)
2. AZ Department of Environmental Quality (ADEQ)

C. **LOCAL AUTHORITIES**

1. Flood Control District of Maricopa County (FCDMC)
2. Maricopa County Department of Health
3. City of Scottsdale (city)

D. **COORDINATION**

Applicants are responsible for coordinating with other interested parties, including utilities, federal and state agencies. Other agency permits may be necessary before applying for city permits. Applicants should consider the timeframes for obtaining those other permits

STANDARDS

4-1.002

- A. 44 CFR
- B. ADWR State Standards
- C. Drainage Design Manuals for Maricopa County
- D. Scottsdale Design Standards and Policies Manual (DSPM)

RESOURCES

4-1.003

A. FEDERAL

1. National Flood Insurance Act
2. Flood Insurance Rate Maps (FIRMs)
3. Clean Water Act (CWA)
4. USDA Natural Resources Conservation Service (NRCS) soil survey maps
5. National Oceanic and Atmospheric Administration (NOAA)

B. STATE

1. ADWR
2. ADEQ

C. LOCAL

1. Environmentally Sensitive Lands (ESL) Ordinance, Scottsdale Zoning Ordinance
2. SRC, particularly Chapter 37
3. Scottsdale forms
4. Scottsdale aerial photos
5. Scottsdale Records Department
6. Flood Control District of Maricopa County
7. Maricopa County Health Department Standards

FLOODPLAIN MANAGEMENT

4-1.100

- A. The city's design, construction and documentation requirements for development in Special Flood Hazard Areas (SFHAs) and pending SFHAs are in SRC, Chapter 37 and this manual. Unless otherwise approved by the Floodplain Administrator, each project must conform to the city's requirements.
- B. All habitable structures must be designed so that they will not be inundated in a base flood.

PERMIT REQUIRED

4-1.101

Appropriate permits are required before construction or development begins, including placement of manufactured homes, within any SFHA, as mapped on the FIRMs. Applications for permits shall be made on city forms and may include, but are not limited to, plans drawn to scale showing the nature, location, dimensions and elevation of the area of development, existing or proposed structures, fill, excavation, storage of materials, and drainage facilities. Specifically, the following information is required:

- A. Proposed elevation in relation to North America Vertical Datum of 1988 (NAVD 88) of the lowest floor (including basement) of all structures. In Flood Zone AO, the location and elevation of the existing highest adjacent natural grade and proposed elevation of lowest floor of all structures.
- B. Proposed elevation in relation to NAVD 88 to which any non-residential structure will be floodproofed.
- C. Certification by an engineer or architect that the floodproofing methods for any nonresidential structure meet the floodproofing requirements of SRC Chapter 37 and FEMA, including, but not limited to, FEMA Publication P-936.

- D. Base Flood Elevation (BFE) for all development within or in proximity to floodplains.
- E. Description of the extent to which any watercourse will be altered or relocated as a result of proposed development. See Section 4-1.500 Activities Requiring a Drainage Report & Plan.
- F. [No-rise certification](#) for development in floodways.

SPECIAL FLOOD HAZARD AREAS

4-1.102

- A. Portions of the city fall within special flood hazard areas, as mapped on the FIRMs. Special flood hazard areas are flood zone designations that begin with an "A" and require attention when being analyzed and designed for development, including alluvial fan flood zones which are designated as "AO" on the FIRMs.
- B. There are special requirements for developing on an alluvial fan in Flood Zone AO:
 - 1. Residential structures shall be constructed in accordance with SRC, Chapter 37.
 - 2. The Regulatory Flood Elevation (RFE) must be determined to set the LF_{88} for residential structures in Flood Zone AO. The RFE = the Highest Adjacent Natural Grade (HAG) Elev + AO depth No. + 1ft of freeboard.
 - 3. The LF_{88} is the lowest finished floor elevation of the structure, including the attached garage, unless the attached garage is wet floodproofed, in which case it becomes the lowest finished floor elevation within the habitable portions of the structure.
 - 4. Wet floodproofing is allowed in attached garages that are used exclusively for vehicular parking, limited storage, or building access. Wet floodproofing consists of constructing flood-resistant materials to the RFE and installing flood vents on at least two walls (if possible) to automatically equalize hydrostatic and hydrodynamic forces across the exterior garage walls. Flood vents shall have one square inch of open space for every square foot (sq.ft.) of enclosed space below the RFE, or they can be specifically engineered. Flood vents shall be within 1 foot of the ground surface. Only the portion below the BFE counts toward the minimum open space requirement.
 - 5. The lowest floor and attendant utility and sanitary facilities for non-residential structures shall either be elevated to the RFE or dry floodproofed to the RFE.
 - 6. Site design and grading shall include adequate drainage paths around structures to guide floodwaters away from proposed structures. Structures shall not be placed in low spots or block active channels or flow paths.
 - 7. The proposed development must address all potential flood hazard impacts created by the project within the flood hazard zone (other areas of the alluvial fan), including adjacent and downstream areas beyond Flood Zone AO.
 - 8. A property located below the apex of an alluvial fan, where the alluvial fan has not been structurally contained from the apex to the property, must protect its upstream perimeter with structural flood control measures. There are two analytical methods to design these measures:
 - a. If the actual flow rate reaching the perimeter is lower than the flow rate at the apex, the city staff may approve using the lower flow rate if flood control is demonstrated by sound engineering analyses.

- b. Otherwise, the structural flood control measures must be designed to withstand the entire flow originating from the apex, plus tributary flows, during a base flood, based on existing watershed conditions (if runoff from the upstream watershed will not increase in the future).

SUBSTANTIAL IMPROVEMENT & DAMAGE IN SFHAS

4-1.103

- A. This section applies when a structure in an SFHA is not in compliance with current standards, and:
 1. Improvements requiring a building permit are proposed; or
 2. Repairs to damage, requiring a building permit, are proposed.
- B. Upon application to the One Stop Shop for a building permit, if it appears that this section is applicable to the project, the applicant shall submit an appropriate Substantial Improvement/Substantial Damage Worksheet, available at the city's website. The [Substantial Improvement/Substantial Damage Worksheet](#) is a screening tool to establish which projects exceed 60% or are less than 40% of the structure's existing market value before the improvements or repairs. Please note that there is one worksheet for single-family residences and a separate one for commercial, industrial, and multi-family residential structures.
- C. If it appears that the project costs between 40% and 60% of the structure's existing market value, the applicant shall provide an appraisal of the value of the existing structure (excluding land value and other improvements to the property such as a swimming pool or accessory structures, before improvements and/or repairs), and a signed construction proposal from an Arizona licensed contractor.
- D. An applicant may bypass the Substantial Improvement/Substantial Damage Worksheet, or challenge the Worksheet's calculation, by providing an appraisal of the value of the existing structure as described in C. above and a signed construction proposal from an Arizona licensed contractor or concede that the development proposal is a substantial improvement.
- E. In case of substantial improvements or repairs to substantially damaged structures, defined as projects costing 50% or more of the value of the existing structure, the entire structure must be brought into compliance with the city's floodplain management regulations.
- F. See also Fig. 4-2.1. Building in a High Risk, Special Flood Hazard Area (SFHA).
- G. Refer to [FEMA's guide to substantial damage and substantial improvements](#).

GARAGES IN SPECIAL FLOOD HAZARD AREAS

4-1.104

Refer to [SRC §37-26](#) and [FEMA's guide for garages](#).

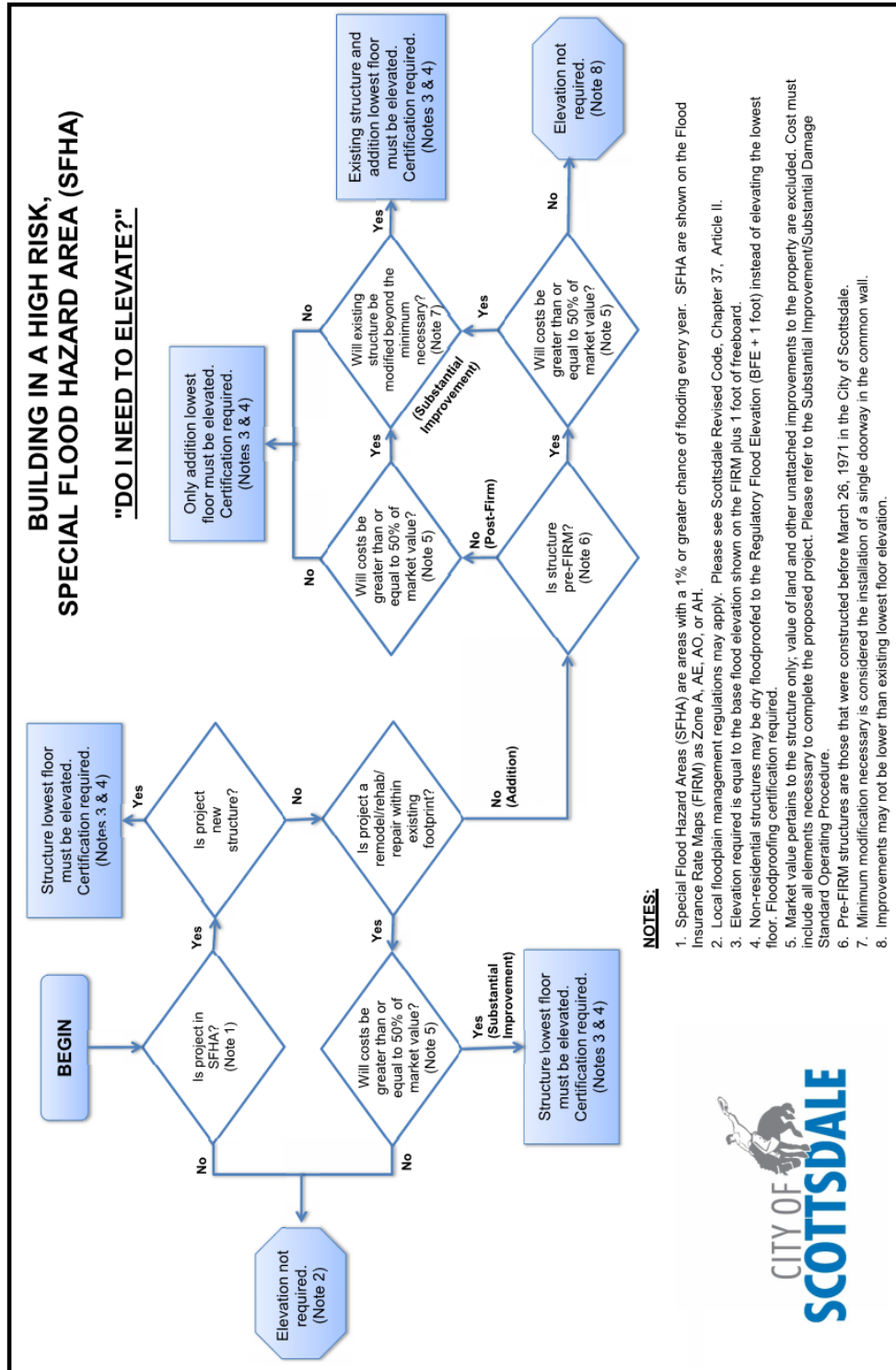

FIGURE 4-1.1 BUILDING IN A HIGH RISK, SPECIAL FLOOD HAZARD AREA (SFHA)

STORMWATER MANAGEMENT

4-1.200

- A. Use the design standards and methodologies described in the DSPM and the Drainage Design Manuals for Maricopa County which include Volume I Hydrology,

Volume II Hydraulics and Volume III Erosion, as well as the Maricopa County Drainage Policies and Standards Manual. The DSPM prevails in any conflict between the County Manuals and the DSPM. Engineers should discuss any conflict with the appropriate city staff for resolution before submitting reports and plans for review.

- B. The city's stormwater storage requirements are contained in SRC, Chapter 37, Stormwater and Floodplain Management ordinance.

STORMWATER STORAGE

4-1.201

A. **GENERALLY**

Stormwater storage facilities shall be designed primarily as detention facilities. Other stormwater storage facilities, such as retention basins utilizing basin floor percolation and dry wells are less acceptable. Stormwater storage facilities utilizing pumps and injection wells are rarely acceptable and will only be allowed in accordance with the SRC.

B. **TYPES AND METHODS OF DRAINING STORMWATER STORAGE FACILITIES**

The various types of stormwater storage facilities are rated for effectiveness, reliability, and ease of maintenance with a rating of 1 as the most preferred and a rating of 4 as the least preferred.

1. Rating 1 – Detention Basins

The stormwater storage facility shall be designed as a detention basin with a positive outflow pipe that can drain the facility within 36 hours.

2. Rating 2 – Retention Basins Utilizing Basin Floor Percolation

A retention basin utilizing basin floor percolation for the dissipation of stormwater may be permitted, subject to stormwater staff approval if:

- a. There is no available outlet for a detention basin or the cost to tie-in to an available outlet is cost prohibitive, results in significant environmental impact in conflict with ESL, or substantial impacts to public facilities as deemed by stormwater staff.
- b. Engineering analysis shows that available outlets would be overtaxed by detention basin outflow.
- c. The applicant can illustrate the basin(s) will drain within 36 hours in accordance with the following guidelines. The applicant shall provide a drain time calculation that has been signed and sealed by a professional engineer for drain times based on a) infiltration rates as determined by double-ring infiltrometer testing in accordance with FCDMC methodology taken at the location of proposed basin(s); b) the proposed 100-year depth of stormwater within the basin(s); and c) a factor of safety of two to account for reductions in basin floor percolation rates over time. A percolation test and drain time calculation is required for each basin proposed to be drained by basin floor percolation unless prior approval is obtained by stormwater staff. However, basins draining by basin floor percolation with a 100-year depth of 6 inches or less do not require a percolation test and drain time calculation for approval of their use.

3. Rating 3 - Retention Basins Utilizing Dry Wells
A retention basin utilizing dry wells for the dissipation of stormwater may be permitted, subject to stormwater staff approval, if:
 - a. Stormwater storage basins based on ratings 1 and 2 are deemed not feasible by stormwater staff.
 - b. A dual-chamber system is designed and installed to minimize sedimentation and pollution of the drywell; and
 - c. State and federal authorities issue the applicable permit(s).
4. Rating 4 - Detention Basins Utilizing Pumps or Injection Wells
Pumping or an injection well may be permitted, subject to Stormwater staff approval, if:
 - a. The owner demonstrates extreme hardship that the owner did not create;
 - b. Stormwater storage basins based on ratings 1, 2, and 3 are deemed not feasible by stormwater staff.
 - c. State and federal authorities issue the applicable permit(s); and
 - d. The owner provides an agreement that states the owner is responsible for the function, maintenance, repair, and replacement of the facility in perpetuity and indemnifies the city from these responsibilities. This agreement shall be recorded against the property and responsibility for the facility shall run with the land.

C. STORMWATER STORAGE FACILITIES VOLUME

1. Design Volume
 - a. For sites that have not been previously developed, or portions of a site thereof, the standard formula for determining the required stormwater storage runoff volume is shown below:

$$V_r = C(R/12) A$$

V_r = Required storage volume in cubic feet.
 R = Precipitation amount = the depth in inches of the 100-year, 2-hour rainfall, from figure in Appendix 4-1C or the NOAA website for the site location.
 A = Area in square feet of total disturbed area attributable to the development, including:

 - (1) Easements, tracts and rights-of-way within the development, plus
 - (2) Where the development includes street improvements to the rights-of-way on the perimeter of the property, the area of those improvements up to the centerline. C = Weighted average runoff coefficient over disturbed area
 - b. For sites that have been previously developed, or portions of a site thereof, the formula for determining the required stormwater storage runoff volume is shown below:

$$V_r = \Delta C(R/12) A$$

V_r = Required storage volume in cubic feet.
 R = Precipitation amount = the depth in inches of the 100-year, 2-hour rainfall, from figure in Appendix 4-1C or the NOAA website for the site location.

A = Area in square feet of total disturbed area attributable to the development, including:

- (1) Easements, tracts and rights-of-way within the development, plus
- (2) Where the development includes street improvements to the rights-of-way on the perimeter of the property, the area of those improvements up to the centerline.

In the formula, ΔC is equal to the increase in the weighted average runoff coefficient over disturbed area ($C_{\text{post}} - C_{\text{pre}}$) and the existing condition C value is based on a weighted average of C values over the site based on historical aerial photographs or other data acceptable to city stormwater staff documenting the existing condition C value and a weighted C calculation. Pre and post weighted average C value calculations shall be submitted for review and approval by city stormwater staff.

Sites that have been previously developed consist of those sites where the city has issued a permit for grading of the site or the site was graded or developed prior to 1987 regardless of issuance of a city permit.

However, any existing stormwater storage volume associated with the previously developed areas of a site or portions thereof must be maintained and added to the volume calculation above for the previously developed portions of the site.

Additionally, for the previously developed portion of site, the project will not be required to provide storage more than the full storage calculation for sites that have not been previously developed.

In all cases, as part of the design of stormwater management system for previously developed sites or portions thereof, the applicant must illustrate no increase in outflows from the site or applicable portions of the site from pre-development conditions.

- c. For sites within the ESL zoning district, applicants may either design and construct 100-year/2-hour stormwater storage basins or design basins adequately sized to attenuate post-development peak discharge rates to pre-development levels for the 10- and 100-year flood events.
 - d. The storage requirement is not applicable to undisturbed, natural areas. Such areas on a site may be excluded from the area used in the storage requirement calculation.
 - e. Stormwater storage facilities storing less than the 100-year, 2-hour rainfall may be approved in accordance with SRC, Chapter 37, Stormwater and Floodplain Management.
2. First Flush Volume
- a. The first flush volume shall be calculated using the following formula:
 $V = CPA$, where:
 V = the required first flush storage volume, in cubic feet;
 C = the weighted average runoff coefficient for the disturbed area of the proposed development;
 P = the required precipitation depth of 0.5 inches, converted to feet; and
 A = the disturbed area of the proposed development, in square feet.

- b. Retention of the first flush volume is encouraged, if the stormwater storage facility will be fully evacuated within 36 hours based on the requirements contained within Section 4.1-201(B)(2).
- c. The city may consider other measures of addressing the first flush requirement subject to review and approval by the Water Quality Coordinator.
- d. For sites that are less than one acre in size and are not likely to contribute stormwater contaminants to the city's municipal separate storm sewer system or waters of the U.S., the first flush volume may be waived, subject to prior approval by stormwater staff. If the first flush volume is waived, other stormwater controls may be required, subject to approval by stormwater staff.
- e. Before final acceptance, or before the issuance of a certificate of occupancy (C of O), the engineer/property owner must provide the city with certified, as built dimensions of the facilities, and the actual volume of storage provided.
- f. The actual volume of storage provided must:
 - i. Be based on as-built topographic surveys performed by an engineer or surveyor;
 - ii. Reflect permanent, finished landscaping in place;
 - iii. Meet or exceed the required volume;
 - iv. Be constructed to perform as designed; and
 - v. Be certified by an engineer.
- g. The volume of storage provided must equal or exceed the approved design volume before the city will issue a C of O.

D. STORAGE FACILITIES DESIGN

1. Storage facilities shall be located to intercept the flows generated from the entire development, to the extent practicable.
2. There shall be proportionality between proposed basin volumes and the anticipated runoff from the basin's associated contributory watershed unless this issue is addressed by other means such as equalizer pipes, basins in series, etc.
3. Storage facilities shall be designed to allow for regular vehicular maintenance activities, such as access for inspection and removal of sediment, debris and other obstructions. The design of smaller storage facilities, which are defined as basins 30 feet or less in top width regardless of length, shall include measures to allow maintenance from one of the longer sides of the basin. On larger basins or basins that cannot be accessed along one of the longer sides of the basin, the design of the basin shall include the following setbacks to allow maintenance of the basin:
 - a. Where storage facility maintenance may be obstructed by a wall, fence, handrail, structure or building, the storage facility shall be set back at least 10 feet from the fence, handrail, structure or building to allow for access.
 - b. Storage facilities shall be set back at least 10 feet from the property line.

- c. In lieu of providing the setbacks provided in a and b above, the applicant may provide measures that allow access to the bottom of the basin.
 - d. Storage facilities shall be set back at least 5 feet from the right-of-way. (format as number 4)
4. In-line storage facilities are discouraged because they can interrupt the natural flow of the wash and can create continual debris and sediment obstruction problems, as well as erosion problems downstream. However, in-line storage basins may be considered on smaller washes having post development 100-year flow rates of 50 cubic feet per second (cfs) or less if it can be illustrated there are no significant sediment transport concerns. The use of in-line storage facilities requires advance approval from stormwater staff.
5. Storage facilities should be designed with a positive gravity draining outfall as provided in Section 4.1-201(B).
6. Basin side slopes shall not exceed a 4:1 (4 horizontal to 1 vertical) ratio and 100-year basin depths shall not exceed 3 feet. Exceptions may be considered in case of hardship the owner did not create on a case-by-case basis. In such cases, fencing, handrail, or some other suitable physical barrier of adequate height to prevent access shall be designed and constructed for safety purposes.
7. Storage facilities shall be designed for emergency overflows of the basin from outlet clogging or extreme flooding events.
8. Above-ground storage facilities contained by an embankment, dam, or levee are generally prohibited. If above-ground storage facilities contained by an embankment dam, or levee are permitted, the facilities must be designed and constructed to mitigate the potential for embankment failure according to generally accepted geotechnical-, and, if necessary, structural-engineering principles. Slope stability, piping, seepage, sliding, overturning and material integrity shall be considered.
9. Except as provided in 11. below, stormwater storage facilities for residential subdivisions shall be in a tract.
10. Stormwater storage facilities for a residential minor subdivision may be located on a private lot if the owner:
 - a. Provides a physical demarcation such as fencing around the stormwater storage facility, to avoid interference with its purpose, in accordance with an approved plan, and
 - b. Dedicates legal access from a right-of-way or a private roadway tract to the facility.
 - c. Provides unobstructed physical and visual access from right of way or a private roadway tract to the facility.
11. Storage basins and related facilities shall be designed to drain to a recognized watercourse. Unless otherwise approved by stormwater staff in advance, stormwater may not generally be discharged onto a city street, gutter or alley.
12. A stormwater storage facility shall not detain or retain standing water longer than thirty-six (36) hours unless the facility is designed and constructed to be a

permanent body of water with appropriate health, safety, and water quality measures.

13. Drain times for full storage facilities should be maximized to ensure the effectiveness of the facilities. Drain times should generally be from 12 to 24 hours.
14. Drain times for partial storage facilities shall be designed to maximize the attenuation of peak discharge rates from the facilities.
15. For stormwater storage basins designed as detention basins and being used to address first flush stormwater quality requirement, the invert of the outflow pipe shall be located typically 3 inches above the basin floor.
16. The outflow discharge from basins may be regulated with use of orifice plates placed over the entrance of the outlet pipe. The orifice size should be a minimum of 6 inches in diameter unless the clogging potential of the orifice is mitigated by other means in the design of the outlet works.
17. Stormwater storage may occur in a parking lot if the following conditions are met:
 - a. The first 50% of the total required storage volume is provided in an above-ground stormwater storage basin or underground storage tank, if approved;
 - b. No more than 50% of the total required storage volume is provided in the parking lot;
 - c. The depth of water does not exceed six inches at any location in the parking lot;
 - d. Interference with pedestrian traffic is minimized where the parking lot acts as a storage facility; and
 - e. A public drainage easement will not be required by the city over the limits of 100-year inundation for areas of storage within parking lots only.

UNDERGROUND STORMWATER STORAGE POLICY

4-1.202

A. POLICY

This policy supplements the SRC requirements for all stormwater storage. Underground stormwater storage involves constructing underground tanks, pipes, or vaults that accept stormwater runoff by means of inlets and storm drain (SD) pipes. The city approves underground storage only after rigorous analysis of storage system location, specifications, access, operation and maintenance, liability, and signage.

B. PROJECTS QUALIFYING FOR UNDERGROUND STORMWATER STORAGE

1. Project must meet the following criteria:
 - a. The project must be located within an industrial, commercial, or multi-family development.
 - b. Residential development may be considered on a case-by case basis subject to the following considerations:
 - i. The development shall have a minimum of 20 lots.
 - ii. The proposed storage facilities do not include contributing watersheds that includes natural desert or mitigation of are not subject to sedimentation

- iii. The viability of the property maintenance organization as discussed below is acceptable to the City.
2. The project must have a viable property maintenance organization or other maintenance mechanism to assume the continued maintenance, repair, and the potential replacement of the underground stormwater storage system and to protect the public's interest. The viability of the property maintenance organization or other mechanism shall be approved by the city on a case by case basis based on an assessment of the long-term ability of the property maintenance organization or other mechanism to maintain, repair and potentially replace the system in conjunction with the review of development review and preliminary plat submittals for the project.

C. GENERAL CRITERIA FOR UNDERGROUND STORMWATER STORAGE SYSTEM DESIGN

1. Underground stormwater storage systems must demonstrate protection of public health, safety, and welfare as established by the SRC and related policies.
2. Storage systems must not be located under structures, parking garages, or significant landscaping such as trees or sizable cactus that would preclude access to or replacement of the facilities.
3. The owner must dedicate a public drainage easement to the city which meets the standards for all drainage easements.
4. Design must address:
 - a. Water quality protection measures to protect underground and surface water resources to meet applicable water quality standards.
 - b. Vector control within storage system.
 - c. Redundancy in case of storage system failure, with attention to the possibility of structure or street flooding, sediment accumulation, or storm events that are greater than the 100-year, 2-hour event.
 - d. Initial suspended sediment load removal.
 - e. At least a 75-year life of entire system, including the lining and coating of the underground storage tank.
 - f. Drainage by gravity. Pumped systems will only be considered if no other reasonable alternative exists with dry wells as a preferred alternative if drainage by gravity is not feasible.

D. SPECIFIC CRITERIA FOR UNDERGROUND STORMWATER STORAGE DESIGN

1. Outfall—underground storage systems must have some sort of outfall, such as gravity drains or pumps.
2. Pipes—underground storage system pipes must have a smooth interior floor. The city's Maricopa Association of Governments (MAG) supplemental standard detail 2554 shall be used to meet the smooth interior floor requirement for the use of corrugated metal pipes in underground stormwater storage facilities.
3. Installation—excavation, bedding, and backfill procedures and materials must be in accordance with MAG standards.
4. Access—a minimum of two access points must be provided for each underground storage system unless waived in advance by stormwater staff to enable inspections and access for removal of accumulated sediment and

debris. Access must be in accordance with MAG standards and be placed to maximize the ability to maintain the underground system.

E. CRITERIA FOR OPERATIONS, MAINTENANCE AND LIABILITY

1. Operations and maintenance generally—owner must provide:
 - a. Maintenance staff with expertise in operating, inspecting, and maintaining an underground stormwater storage system;
 - b. An Operations and Maintenance Manual on site for the system that includes:
 - i. a schedule for inspections and maintenance, and
 - ii. provisions for emergency operations due to power failure, pump failure, and clogged outlet structures;
 - iii. A log of the inspections and required maintenance services.
2. Inspections and maintenance required—In addition to maintenance required by the SRC and other applicable requirements, owner shall:
 - a. Inspect system after each storm event of 0.6 inch or more, and semiannually, preferably before summer and winter rains.
 - b. Remove accumulated trash and debris from inlet and outlet structures as needed to ensure free flow of stormwater.
 - c. Inspect all other elements of the drainage system (pipes, geotextiles, and stone) and repair/replace elements as needed for the storage system to operate at peak efficiency.
3. Signage—before receiving a C of O, the owner must install signs at each end of the underground storage tank that read “Notice—Underground Stormwater Storage Tank.” The size, color, and locations of signs are subject to city staff approval.
4. Ownership Responsibility Statement – The owner shall provide and sign a statement of responsibility for the system stating and acknowledging the owner is responsible for the maintenance, repair, and potential replacement of the system. Prior to final plan approval, the owner must provide a signed and notarized document to this effect, in a form satisfactory to the City Attorney, for recordation by the city in the Maricopa County Recorder’s Office.

STORMWATER STORAGE WAIVERS

4-1.203

A. WAIVER OF STORMWATER STORAGE REQUIREMENTS

See SRC, Chapter 37, for waiver criteria. A waiver approval does not relieve the developer of liability if flood damage occurs resulting from the waiver.

B. WAIVER OF FIRST FLUSH

Generally, there is no waiver for stormwater storage volume required to hold runoff from the first one-half inch of precipitation. However, the owner may provide a smaller basin and/or alternative stormwater controls, to the satisfaction of the Stormwater Quality Coordinator.

C. WAIVER PROCESS

To apply for a stormwater storage waiver, the developer shall complete and submit a stormwater storage waiver application in conjunction with the preliminary drainage report as part of the development review or preliminary plat or similar case submittal for the project.

More specifically, the following applies:

1. Provide and fill out a Request for Stormwater Storage Waiver Form, including the in-lieu fee and in-kind contributions calculations sheet; refer to [Stormwater Storage Waiver](#); and
2. Provide a certified engineering report or other satisfactory documentation that the project qualifies for a waiver.
3. City staff may request additional information. The Floodplain Administrator may deny the waiver, approve it, or approve it with conditions.
4. Stormwater storage waiver fees, as determined by the approved stormwater storage waiver, shall be paid prior to or in conjunction with obtaining the first permit for improvement plans for the project associated with the waiver.

It should be noted that stormwater storage waivers are not required for projects within the ESL zoning district, for redevelopment projects, and for projects located within the McDowell Sonoran Preserve that meet stormwater storage requirements pursuant to SRC Section 37-50.

D. **IN LIEU FEES**

1. If stormwater storage is waived, the developer shall be required to pay an in-lieu fee. In lieu fees may be applied to the construction of drainage improvements throughout the City. To calculate the amount of in lieu fees based on the volume of stormwater storage waived, see Section 4-1.203.C, Stormwater Storage, above; and [Stormwater Storage Waiver](#) form.
2. The Floodplain Administrator may approve in-kind stormwater management facilities to reduce the in-lieu fee.

STREET DRAINAGE

4-1.204

A. **ACCESS**

Generally, street improvements for new development shall provide access to properties during a base flood. To prove access, an engineer must demonstrate that at least one structural roadway section with asphalt, concrete or compacted aggregate has a depth of flow no greater than 1 foot during a base flood. Refer to Fig. 4-3.1, Street Hydraulic Design Criteria Chart, for limits of inundation for specific street sections. Refer to SRC, Chapter 37, Stormwater and Floodplain Management, for exceptions to this provision.

B. **GENERAL DESIGN STANDARDS**

Streets may carry water from adjacent property and from local areas but should not be used as major water carriers in lieu of natural washes or man-made channels. The design criteria below imply that water may flow deeper than a normal vertical curb height, for a short distance over sidewalk or other back-of-curb areas, but the flow is always confined to the right-of-way or drainage easements. Engineers should provide catch basins, scuppers, or similar facilities, together with necessary channels, at appropriate locations (particularly street sag areas) to remove water flowing in the streets to comply with the design criteria below:

HYDRAULIC DESIGN CRITERIA			
DRAINAGE FEATURE	PEAK FREQUENCIES		
	10-YEAR	25/50-YEAR	100-YEAR
Street with Curb & Gutter	Contain runoff within street curbs. For collector and arterial streets maintain one 12-foot- wide dry driving lane in each direction.	N/A	Contain runoff below the building's lowest floor. Confine runoff to street rights- of-way or drainage easements. d max =8 inches.
Street without Curb & Gutter (Dirt Roads, Ribbon Curbs)	Contain longitudinal runoff within roadside channels with water surface elevation below pavement subgrade.	N/A	Contain runoff below the building's lowest floor. Confine runoff to street rights- of-way or drainage easements. d max =8 inches.
Street without SD System	Add pipes or roadside channels if runoff from 10-year flood exceeds street capacity, unless waived per SRC, Chapter 37.	N/A	Add SD systems if a base flood inundates building's lowest floor. Provide catch basins, scuppers, etc. to remove water so d max =8 inches.
Cross Road Culvert or Bridge for Major Collector & Arterial Streets	N/A	Convey runoff by culvert or bridge under street with no flow overtopping the street for a 50-year flood, except as provided in SRC, Chapter 37.	Convey runoff by culvert and by flow over the street so d max =6 inches, except as provided in SRC, Chapter 37.

HYDRAULIC DESIGN CRITERIA			
DRAINAGE FEATURE	PEAK FREQUENCIES		
	10-YEAR	25/50-YEAR	100-YEAR
Cross Road Culvert or Bridge for Local and Minor Collector Streets, Local Residential* and Commercial/Industrial Streets	Convey runoff by culvert or bridge under street with no flow overtopping the street, except as provided in SRC, Chapter 37.	For a 25-year event, convey runoff by culvert or bridge and by flow over the street with so d max =6 inches, except as provided in SRC, Chapter 37.	d max =12 inches, except as provided in SRC, Chapter 37.
Any street or watercourse crossing that provides the only access to residential area.	N/A	N/A	Make all lots and structures accessible by at least 1 street with d max =12 inches for a base flood, except as provided in SRC, Chapter 37.
*Local Residential Streets with Low Volume Average Daily Trips (ADT)	See Low Volume Street Standards, Chapter 5		

FIGURE 4-1.2 STREET HYDRAULIC DESIGN CRITERIA CHART

C. VALLEY GUTTERS

Valley gutters are permitted on local streets to transport runoff when a SD system is not required. Valley gutters are generally not acceptable on collector or arterial streets. In unusual cases, valley gutters may be necessary to convey runoff across a collector street. In such situations, the valley gutter shall be a minimum of 8 feet wide to lessen the impact on traffic.

D. ROADSIDE SWALES

Unless waived by city staff, swales must intercept and safely convey flow to the nearest recognized watercourse within the same watershed. If velocities exceed 5 feet per second (fps), then the engineer must design the swale to provide erosion and scour protection. Swales are necessary to prevent:

1. Runoff and debris from washing onto the roadway,
2. Erosion of roadway areas adjacent to the edge of pavement or curbing, and

- Roadway runoff from flowing into front yards, driveways, garages and homes. Refer to Figure 4-1.3, Typical Cross Section for Roadside Swales, on non-raised curb street or straight cross slope.

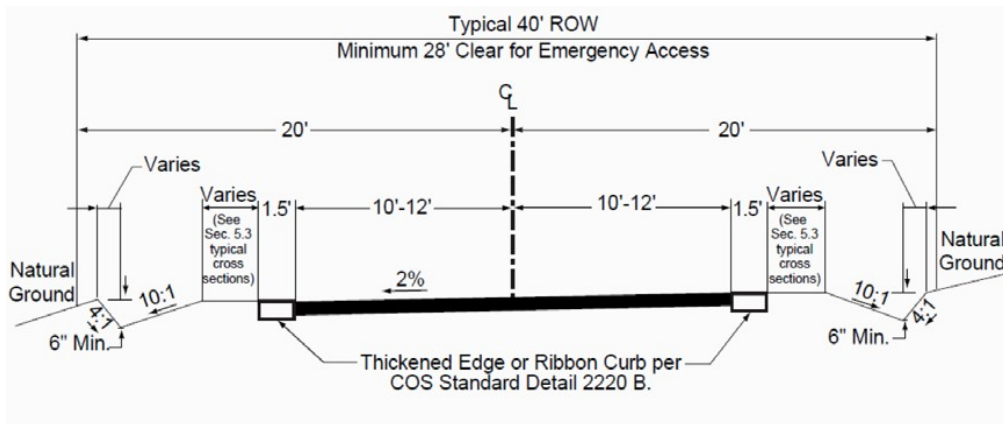

FIGURE 4-1.3 TYPICAL CROSS SECTION FOR ROADSIDE SWALES

E. WET CROSSINGS

For road wet crossings, calculate flow velocity for sediment erosion. Erosion control measures for scour protection must be evaluated and documented.

CHANNEL LINING

4-1.205

- A. The policies for channel lining city-wide are set forth in Section 2-1.802.
- B. Channel sections shall be designed so the final finish grade is the surface of any channel lining or erosion protection. Channel capacity shall be designed to increase capacity to accommodate reductions in flow capacity from landscaping, revegetation and sediment accumulation, as shown in Fig. 4-1.4, Channel Lining Design Capacity.

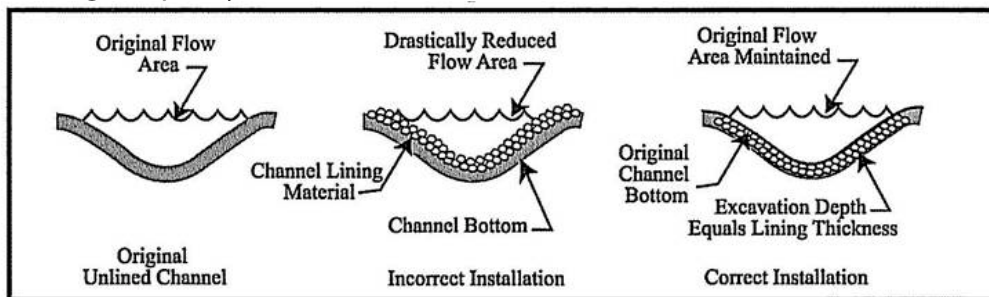

FIGURE 4-1.4 CHANNEL LINING DESIGN CAPACITY

CULVERTS & STORM DRAINS

4-1.206

- A. The minimum pipe size of culverts and SD laterals shall be 18 inches in diameter. Where debris may be expected, follow the FCDMC requirements for clogging.
- B. Private culverts should be sized to manage the 100-year runoff but should not be less than 15 inches in diameter when possible. Culverts that do not have 100-year peak flow capacity must be designed to adequately convey the balance of runoff by channel or other means to the appropriate watercourse.
- C. Bubble-up structures are strongly discouraged. They may only be considered in the event of extreme hardship that the applicant did not create. Use of bubble-up structures is subject to the Floodplain Administrator's approval.
- D. If a culvert invert is placed below the natural wash flow line, the design capacity of the culvert must be reduced by the cross-sectional area below this level.
- E. Stormwater runoff cannot be conveyed in a culvert under structures, except to drain a fully laterally enclosed courtyard, where redundancy is required.
- F. Manholes or junction structures are required at all horizontal and vertical changes in culvert alignment, pipe junctions, and changes in pipe diameter.
- G. The hydraulic grade line in SDs shall be no higher than six inches below the gutter line in a 10-year flood.
- H. Minimum drainage easement widths shall be calculated using the following formula: $\text{Width} = \text{pipe outside diameter} + 2 \text{ feet} + 2 \times \text{depth to invert}$.

STORMWATER MANAGEMENT

4-1.300

- A. The city uses, as a minimum, design standards and methodologies in the [ADWR Erosion Hazard Guidelines](#) and [FCDMC Hydraulics Manual](#). These apply to:

1. Structures that could fail or incur significant damage as a result of erosion.
 2. Proposed structures that, if built, could result in adverse impacts to adjacent properties.
 3. Watercourses that do not have identified erosion hazard zones.
 4. Watercourses within existing or proposed land divisions.
 5. Watercourses identified by the city as having significant potential flood hazards.
 6. Watercourses with drainage areas equal to or greater than 30 acres or a 100-year peak discharge estimate of more than 50 cfs, as estimated using the procedures in the FCDMC Hydrology and Hydraulics volumes.
- B. Erosion hazard zones consistent with ADWR may be required for all properties under development where watercourses will be left in an undisturbed state. The city may require further analysis (ADWR Level II or III) under certain geomorphic conditions where staff is concerned that erosion limits may exceed those estimated by a Level I analysis. The city may also require a slope stability analysis. In distributary flow watercourses, the stability of flow divergence locations and washes should be determined before approval of a proposed structure.
- C. Proposed modifications should not disturb the natural divergence location(s), especially if adjacent parcels may be adversely impacted.
- D. Erosion hazard guidelines should be applied to all divergent watercourses adjacent to the proposed structure.
- E. Proposed development design should limit vegetation removal and concentration of flow to an absolute minimum.
- F. The swales around a structure should daylight and broaden to the original sheet flow condition on the downstream side of structure. Appropriate scour and/or erosion protection may be required in the swale.

STORMWATER QUALITY

4-1.400

CONSTRUCTION GENERAL PERMITS

4-1.401

- A. ADEQ administers the Construction General Permit under the CWA. The city requires evidence that the development will comply with the ADEQ Construction General Permit, when applicable, before issuing development permits.
- B. Stormwater runoff from construction sites can include pollutants such as phosphorous, nitrogen, pesticides, petroleum derivatives, construction chemicals, solid wastes and sediment that adversely affect water quality. Compliance with the Construction General Permit will help prevent these pollutants from entering washes, lakes, other surface waters and the city's SD system.

HOW TO OBTAIN STAFF & CITY APPROVAL

4-1.402

- A. The operator of a construction site is responsible for applying for appropriate permits from ADEQ. The operator may be the owner, developer, general contractor or individual contractor responsible for operational control. When this responsibility is shared, all operators must apply for ADEQ approval. ADEQ will require a Notice of Intent (NOI) and Stormwater Pollution Prevention Plan (SWPPP).

- B. After ADEQ approval, the operator must include 2 copies of the approved NOI and SWPPP with improvement plan submittal to the City.

OPERATIONAL REQUIREMENTS

4-1.403

The operators must keep a copy of the SWPPP on site. In addition to ADEQ enforcement, the city may enforce stormwater management requirements, through inspections, responding to complaints and other means.

COMPLETING CONSTRUCTION

4-1.404

Once construction is completed, as defined in the Construction General Permit, the operators must send a Notice of Termination (NOT) to ADEQ and the City.

SECTION 404 PERMITS

4-1.405

The city requires developments to comply with Section 404 of the CWA.

ACTIVITIES REGULATED UNDER SECTION 404

4-1.406

- A. The USACE and EPA jointly administer Section 404 of the CWA. The CWA regulates the discharge of dredged or fill material into washes, rivers, streams, lakes, certain man-made canals and other waters of the United States, including wetlands.
- B. Examples of activities that might be regulated under this program include:
 - 1. Stream crossings;
 - 2. Dam construction and flow regulation;
 - 3. Water diversion for canals, irrigation systems and stock tanks;
 - 4. Streambed modification and stabilization; and
 - 5. Building subdivisions, master planned communities, nonresidential structures, highways and airports.
- C. Projects with minimal environmental impact require nationwide permits with a streamlined process. Projects with potentially significant impacts may require individual permits with public notice.
- D. Projects cannot jeopardize the continued existence of a threatened or endangered species or its critical habitat. Consult with the USACE or the US Fish and Wildlife Service for guidance concerning threatened and endangered species in the City.

SECTION 401 CERTIFICATION

4-1.407

Before the USACE can issue a Section 404 permit, Section 401 of the CWA requires ADEQ to certify (possibly with additional conditions) that the draft permit complies with effluent limits, state water quality standards, and appropriate requirements of state law. ADEQ may grant, deny or waive water quality certification for both individual and nationwide Section 404 permits. No discharge of dredged or fill material is permitted if:

- A. A practicable alternative exists that is less damaging to the aquatic environment,
or
- B. The nation's waters would be significantly degraded.

COMPLIANCE REQUIREMENTS

4-1.408

The city will not issue any development permit without appropriate USACE action. An applicant must complete the [city Section 404 Certification Form](#) to assure that a

project complies with Section 404 of the CWA, and submit the form with improvement plans.

WASTE DISPOSAL SYSTEM LOCATIONS

4-1.409

- A. Waste disposal system locations shall comply with Arizona Revised Statutes, Section 48-3609.
- B. Waste disposal system locations shall comply with Maricopa County standards.

LOW IMPACT DEVELOPMENT

4-1.410

Low impact development is encouraged, where practicable, and may be used to satisfy some or all a project's stormwater storage requirements, subject to approval by stormwater staff. Reference is made to SRC section 37-56 for alternative stormwater management measures.

The following document is adopted by reference as part of the Design Standards & Policy Manual: [The Low Impact Development Toolkit](#) Prepared for the City of Mesa Arizona.

ACTIVITIES REQUIRING A DRAINAGE REPORT AND GRADING & DRAINAGE PLANS

4-1.500

An applicant may be required to submit a Drainage Report & Grading and Drainage Plans (Grading and Drainage Plans are referred to as "Plans" in Sections 4-1.500 and 4-1.501) when submitting any of the following applications. The specific nature of the Drainage Report and Plans, and the requirements for submittal, will be determined during the pre-application process by a team of city staff.

- A. Rezoning or use permit (UP)
- B. Master development plan
- C. Preliminary and minor subdivision plat
- D. Development Review Board (DRB) case
- E. Final plat and improvement plans
- F. Permit to construct right-of-way improvements
- G. Permit to construct any structure
- H. Grading permit
- I. Modification or release of a dedicated drainage easement

TYPES OF REPORTS AND PLANS

4-1.501

There are sequential levels of Drainage Reports and Plans as development proposals range from broad and conceptual to project-specific and detailed, as well as requirements for master-planned development proposals. Drainage Reports and Plans address stormwater flows and drainage issues that affect a proposed development, plus adjacent and nearby sites; and drainage solutions, in accordance with applicable ordinances and standards, to mitigate adverse effects resulting from the proposed development. All Drainage Reports and Plans shall describe how the proposed development will manage stormwater runoff, the details of infrastructure to be constructed, the sequence of infrastructure installation, and any phasing of the

project. Drainage Reports and Plans for individual single-family residences may vary from the sequence below, subject to city staff approval.

A. Conceptual Drainage Reports and Plans

With rezoning, the applicant shall submit a Conceptual Drainage Report and Plans that identify the basic drainage conditions that apply to the site and possible stormwater management solutions that relate to the proposed development and unique condition of the site. In many cases, the Conceptual Drainage Report and Plans will be included in a Development Plan (DP) as identified in the Zoning Ordinance. The Conceptual Drainage Report and Plans shall show how the drainage systems on the site will relate to and extend existing drainage systems serving adjacent and nearby properties. The Conceptual Drainage Report and Plans shall establish the key elements for consideration in any future Drainage Reports and Plans for the site, including applicable FEMA floodplain designations. A level of detail associated with a 50% level of Drainage Report and Plan completion is typically required.

B. Preliminary Drainage Reports and Plans

With UP, PP, minor subdivision, Development Master Plan and DRB applications, the applicant shall submit a Preliminary Drainage Report and Plans. While a Preliminary Drainage Report and Plans will not contain sufficient detail and accuracy to function as improvement plans, the Preliminary Drainage Report and Plans must provide detailed design concepts, specifications for proposed drainage facilities, and management plans for operating and maintaining the drainage facilities. The Preliminary Drainage Report and Plans present the justification for final improvement plans and lowest floor elevations, the plan for connecting the proposed development to existing and planned drainage facilities on and adjacent to the site; pre- and post-project topography; and stormwater runoff calculations. The Preliminary Drainage Report and Plans shall also demonstrate consistency with any applicable Conceptual Drainage Report and Plans and stipulations associated with approval. A level of detail associated with a 75% level of Drainage Report and Plan completion is typically required. However, if the viability of a proposed site plan, project layout, or lot yield is dependent upon certain aspects of a development's stormwater management plan, then a higher level of analysis and design should be provided for those portions of the stormwater management plan.

C. Final Drainage Reports and Plans

With improvements plans for final plats, construction plans for public infrastructure, and construction plans for on-site development, the applicant shall submit a Final Drainage Report and Plans. A Final Drainage Report and Plans are intended for construction and therefore must be fully detailed; compliant with the DSPM and applicable local, state and federal statutes; and consistent with previously approved Preliminary Drainage Reports and Plans and stipulations.

D. Master Drainage Reports and Plans

For multi-phased and complex development proposals, the city may require the applicant to submit a Master Drainage Report and Plans after a rezoning approval (by stipulation or per the Zoning Ordinance). A Master Drainage Report and Plans

provide the basis for constructing major common drainage improvements that serve an individual phase or property within the proposed development, the entire proposed development, or a portion of the regional drainage requirements. A Master Drainage Report and Plans also establish the drainage improvement requirements necessary for each phase of the development. A Master Drainage Report and Plans shall be submitted before or with the first preliminary plat or DRB case for the site.

STANDARDS

4-1.502

All drainage reports and plans shall conform to the standards in Appendix 4-1A and 4-1B.

- A. All drainage reports and plans should be prepared in conformance to the requirements in this chapter. Hydrology calculations may be performed using Drainage Design Management System for Windows (available at no cost through the FCDMC), HEC-1, HEC-HMS or the Rational Method. Hydraulic calculations may be performed using HEC-RAS. However, the city encourages sound, innovative design and the use of new techniques where special conditions or needs exist. With prior city staff approval, alternate methods, models and procedures may be used with appropriate supporting documentation.
- B. Development shall not increase peak discharge rates above the historic peak discharge rates for the 2, 10 and 100-year storm events.
- C. Proposed grading shall be at least 0.5% to allow for positive drainage. D. At a minimum, drainage reports should meet the following standards:
 1. Reflect local, state, and federal requirements.
 2. Use the best and most current data available.
 3. Provide a clear narrative of the methods used, parameters selected in the analysis and conclusions drawn.
 4. Be technically and legally defensible.
 5. Be well-organized and concise.
 6. Provide safe, reasonable and reliable results.
 7. Provide results that are consistent with adjacent jurisdictions.

LIMITATIONS

4-1.503

The city does not guarantee the reliability of specific hydrologic methods, techniques and/or parameter values. The engineer is expected to validate the reasonableness of the estimated values and design the plan to keep the development and the city relatively safe from flooding. Refer to Appendix 4-1C, Warning and Disclaimer of Liability form. The owner must submit the completed Warning and Disclaimer of Liability form with each grading and drainage plan.

METHODOLOGY & CALCULATIONS

4-1.504

A. **Methods for Estimating Peak Discharge**

There are two methods to determine peak discharge:

1. The Rational Method (generally used for watersheds less than 160 acres that are regularly shaped and uniformly contoured). The methodology is provided in the FCDMC Hydrology Manual.

2. A rainfall runoff model using the USACE’s HEC 1 Flood Hydrograph Package (generally used for watersheds that are larger than 160 acres, irregular in shape and contour, or if routing of flows is necessary).

B. Watershed Conditions

Watersheds are subject to change. Grading and drainage plans shall consider all watershed conditions that would result in the greatest peak discharge rate, to:

1. Size drainage facilities, and
2. Determine lowest floor elevations.

C. Split-Flow Conditions

Projects in northern parts of Scottsdale must address split-flow channel conditions where applicable. These splits in the alluvial channels usually include highly erosive soils and are generally unstable and unpredictable. In setting lowest floor elevations relative to upstream splits, assume that 100% of the flow could go either direction in any given flood event. For infrastructure design, the estimate of the actual split, based on a hydraulic analysis of the current channel cross sections, must include a minimum safety factor of 30% of the total flow. If there are extenuating factors affecting the stability of the split, the safety factor should be increased accordingly.

D. Environmentally Sensitive Lands

For special considerations regarding Environmentally Sensitive Lands, refer to the City Zoning Ordinance and DSPM Chapter 2 Section 2-2. Modification of natural watercourses with a flow of 50 cfs or greater are addressed in the City Zoning Ordinance.

E. The Rational Method

1. Precipitation. Precipitation input is rainfall intensity, “i,” and can be obtained directly from [NOAA 14](#).
2. Time of Concentration. Time of concentration “ t_c ” is the total time of travel from the most hydraulically remote part of the watershed to the concentration point of interest. The calculation of “ t_c ” must follow FCDMC Hydrology Manual procedures.
3. Runoff Coefficients. Use Fig. 4-1.5, Runoff Coefficients for Use with Rational Method, or equivalent to obtain the runoff coefficients or “C” values. Composite “C” values for the appropriate zoning category or weighted average values calculated for the specific site are both acceptable approaches.

RUNOFF COEFFICIENTS – “C” VALUE

LAND USE	STORM FREQUENCY		
	2-25 Year	50 Yea r	100 Yea r
Composite Area-wide Values			
Commercial & Industrial Areas	0.80	0.83	0.86
Residential Areas – Single Family, slopes 10% or less			
R1-190	0.33	0.50	0.53
R1-130	0.35	0.51	0.59

R1-70	0.37	0.52	0.60
R1-43	0.38	0.55	0.61
R1-35	0.40	0.56	0.62
R1-18	0.43	0.58	0.64
R1-10	0.47	0.62	0.70
R1-7	0.51	0.66	0.80
R1-5	0.54	0.69	0.86
<hr/>			
Residential Areas – Single Family, slopes greater than 10%			
R1-190	0.65	0.74	0.82
R1-130	0.68	0.76	0.84
R1-70	0.69	0.77	0.85
R1-43	0.70	0.77	0.85
R1-35	0.70	0.78	0.85
R1-18	0.71	0.79	0.86
R1-10	0.75	0.82	0.88
R1-7	0.81	0.86	0.91
R1-5	0.85	0.89	0.92
Townhouse (R-2, R-4)	0.63	0.74	0.94
Apartments & Condominiums (Condos) (R-3, R-5)	0.76	0.83	0.94
<hr/>			
Specified Surface Type Values			
Paved streets, parking lots (concrete or asphalt), roofs, driveways, etc.	0.90	0.93	0.95
Lawns, golf courses, & parks (grassed areas)	0.20	0.25	0.30
Undisturbed natural desert or desert landscaping (no impervious weed barrier)	0.37	0.42	0.45
Desert landscaping (with impervious weed barrier)	0.63	0.73	0.83
Mountain terrain - slopes greater than 10%	0.60	0.70	0.80
Agricultural areas (flood irrigated fields)	0.16	0.18	0.20
Gravel floodways and shoulders	0.68	0.78	0.82

FIGURE 4-1.5 RUNOFF COEFFICIENTS FOR RATIONAL METHOD

F. HEC-1 Model

1. Minimum submittals
 - a. A printout of the input data.
 - b. A schematic (routing) diagram of the stream network.
 - c. The runoff summary output table, including drainage basin name, area, 2, 10, and 100- year flow values.
 - d. Electronic input file(s) on compact disc (CD) or digital versatile/video disc (DVD).
 - e. Supporting documentation and source material for parameter selection.

- f. A narrative detailing the impact of adjustments to the modeling parameters made to address warnings and error messages.
2. Precipitation
Determine precipitation values for HEC-1 modeling using the FCDMC Hydrology Manual, specifically PD and JD records for point rainfall and area reduction factors. Capital Projects shall use the ADOT manual and methodology when specified. Precipitation values are to be obtained from the Isopluvial maps for the specific frequency addressed, see Appendix 4-1C.
3. Infiltration
Determine infiltration or soil losses using Green and Ampt (G&A) procedures per FCDMC Hydrology Manual. Use the following, most recent, applicable USDA NRCS soil survey maps of the area to determine the hydrologic soil group or surface soil texture for the G&A procedures:
 - a. Aguila Carefree Area.
 - b. Parts of Maricopa and Pinal Counties.
 - c. Eastern Maricopa and Northern Pinal Counties.
4. Hydrograph Generation. Generate small basin or sub watershed hydrographs using the Clark unit hydrograph procedure or S-graph method as described in the FCDMC Hydrology Manual.
5. Time of Concentration ("Tc"). Use the estimated time of travel from the most hydraulically remote part of the watershed to the concentration point. The FCDMC Hydrology Manual is recommended for obtaining Tc.
6. Channel Routing. Use the Normal Depth (Modified Puls), eight-point routing procedure as described in the FCDMC Hydrology Manual for channel routing.
7. Design Storm. The design storm used shall be the 6-hour or 24-hour storm, whichever produces the highest peak flow rates.
8. Existing and Proposed Discharge Analysis. Use the following HEC 1 analysis procedures when necessary to compare existing and proposed discharge (runoff) conditions. Reflect full development conditions
 - a. Increasing the percentage of impervious surfaces on the LG card to show the amount of impervious surface that will exist after full development.
 - b. Recalculating the time of concentration (Tc) based on the proposed drainage system, after full development.
 - c. Subdividing, as necessary, the existing condition model to create concentration points that match the sub-watershed areas above each proposed storage facility after full development.
 - d. Modeling each proposed storage facility as it will physically exist after full development, with appropriate routing and combining operations through each facility and through the entire watershed. Modeling storage capacity provided, as one hypothetical facility at the outlet with all upstream storage arbitrarily combined in the facility, is not acceptable.
 - e. Analyzing the 2, 10, and 100-year frequency events, at a minimum.
 - f. Comparing discharge values for existing and full development at concentration points just downstream from each proposed storage facility,

other critical locations such as road crossings, and points where flows exit the development.

G. Calculation of Runoff Volumes

1. Standard Formula for Runoff Volumes The standard formula for determining the required stormwater storage runoff volume is in Section 4-1.200 above.
2. HEC-1 Computer Modeling. HEC 1 modeling may be used for storage basin design, routing and analysis. Use modified Puls level pool routing option in HEC-1 for hydrograph routing through storage basins and lakes. For permanent lakes, assume no available storage below the normal water surface elevation.

H. Methods for Estimating Water Surface Elevations and Inundation Limits

The engineer may use any standard method for determining water surface elevations. The city prefers the USACE's HEC-RAS, to determine inundation limits. If the applicant uses the USACE's HEC-RAS Computer Models, the minimum required submittals for HEC-RAS are:

1. A printout and CD or DVD of the input and output data.
2. A plan of the contributing stream network and sub-basins with cross section locations and stationing, including flow obstructions, ineffective flow areas modeled and other appropriate parameters at a sufficient scale to support the modeling. Overlay the cross sections on the topographic work map.
3. A detailed output summary table, including flow rates, velocities, water surface elevations, bank stations, n-values, ineffective flow stations, flow obstruction stations and other relevant parameters.
4. Cross section profiles.
5. Supporting documentation and source material for parameter selection.
6. A narrative to validate warning and error messages with details of the impact of adjustments to the modeling parameters on the output, if the city staff allows warning or error messages.

GENERAL EASEMENT INFORMATION

4-1.600

A. Drainage Easement Requirements

[Drainage Easements](#) Are Required Over:

1. Watercourses, except those regulated by the ESL zoning district, with a 100-year, peak discharge rate of 25 cfs or greater,
2. Watercourses regulated by the ESL zoning district with a 100-year, peak discharge rate of 50 cfs or greater, and
3. All drainage and stormwater storage facilities.

B. Extent of Drainage Easement Dedication

A drainage easement shall be dedicated to the city to the limits of stormwater inundation from a base flood for the watercourses described above, plus drainage and stormwater storage facilities. Drainage easement dedications shall encompass all physical structures and sufficient area to access and maintain the facilities, including the setbacks for storage facilities as set forth in Storage Facilities Design above.

C. Access Easement

If the drainage easement is not contiguous to right-of-way, a minimum 10-foot access easement, to maintain the drainage facility with mechanical equipment, shall also be dedicated, regardless of who maintains the drainage facility.

Access easement shall provide a minimum internal turning radius of 25 feet and changes in alignment of the easement.

D. Permits Required

Except for routine maintenance, work and encroachments in a drainage easement dedicated to the city require the same permits as work and encroachments in the public right-of-way. The procedure and terms for permission to work in the right-of-way (PWR) and permits for private improvements in the right-of-way, issued under Chapter 47 of the SRC, apply to permits issued for drainage easements.

E. Maintaining A Drainage Easement

1. Unless otherwise indicated on the document dedicating the drainage easement or in a recorded agreement, the property owner is responsible for maintaining the drainage easement.
2. In addition to the requirements for maintaining a drainage easement in the Stormwater and Floodplain Management ordinance, the owner shall:
 - a. Inspect the drainage facilities after each storm event of greater than 0.5 inches, and semiannually, preferably before summer and winter rains.
 - b. Remove accumulated trash and debris from inlet and outlet structures as needed for the free flow of stormwater.
 - c. Inspect all other elements of the drainage system (pipes, geotextiles, and riprap) and repair/replace elements as needed for the storage system to operate at peak efficiency.

F. Releasing A Drainage Easement

1. A drainage easement may be released only if the applicant documents one of the following circumstances:
 - a. Upstream flows have been physically cut off or diminished;
 - b. More detailed or accurate topographic mapping and/or aerial photography show the original dedication is incorrectly located; or
 - c. The original hydrology is outdated or in error.
2. The applicant must complete and submit the [Application to Release Existing Drainage Easement Form](#) with a comprehensive drainage report that justifies the release as described above.
3. The city staff may determine that retaining the easement is in best interest of the city and may not grant the release. The city staff may impose reasonable conditions before releasing a drainage easement. Once all conditions have been satisfied, as determined by city staff, city staff shall grant the release.

PRELIMINARY GRADING PERMITS

A. Before a preliminary grading permit is issued:

1. All substantial grading and drainage issues associated with a project must be resolved to the satisfaction of the stormwater reviewer.

4-1.700

2. The second plan review of the improvement plans must be completed before applying for a preliminary grading permit unless otherwise approved by city staff.
3. The owner must submit a letter to the city acknowledging the city is not responsible for potential changes to the project associated with the approval of final plans and committing to complying with the final approved plans.
4. For projects with plats, the City Council must have approved the final plat for the project. This requirement may be waived by the Building Official.
5. The owner must obtain a Native Plant Permit. The Native Plant Permit number shall be placed on the improvement plans submitted for the preliminary grading permit.
6. If applicable, the owner must obtain a Haul Route Permit.
7. If applicable, the owner must obtain a Stormwater Storage Waiver and pay any required in lieu fee.
8. The completed No Conflict signature box must be placed on the cover sheet, signed and dated and all applicable No Conflict letters submitted.
9. The owner must provide a copy of approval to discharge from ADEQ for the SWPPP and have a city approval of the SWPPP.
10. The owner must provide a completed Section 404 Certification form; and if applicable, a copy of the permit from the USACE.
11. The owner shall prepare and submit plans that reflect only those improvements for which the preliminary permit is being requested. The plans will be logged into the one stop shop with a separate plan check number than the associated project improvement plans.
12. Ordinarily, a permit may be requested for preliminary grading only. Under special circumstances, the city may consider the additional approval of drainage improvements provided such approval is granted in advance of the submittal.
13. The owner must meet any other project specific requirements to issue a final grading permit.
14. A preliminary grading permit is subject to review and approval by city staff.

EXCESS SITE CONSTRUCTION SOIL

4-1.800

Upon city staff approval, an applicant may temporarily store on-site excess soil from construction operations. To receive approval, the applicant must submit:

- A. A letter signed by the applicant stating the duration of the stockpile and the methods used to control dust.
- B. A plan prepared in conformance with grading and drainage plan requirements, showing the stockpile location.
 1. The stockpile may not be located on, or within, any public utility, easement, right-of-way or watercourse.
 2. The plan must provide at least one cross-section through the stockpile, labeling the side slopes and the maximum height of the stockpile, and show the total volume of the stockpile.
 3. The plan must show and label all Natural Area Open Space (NAOS) areas.

4. The plan must manage drainage runoff from the stockpile and upstream watersheds by considering stockpile location, stockpile design and grading, and/or temporary stormwater storage.

A Native Plant Permit for the area to be used for stockpile. The Native Plant Permit number shall be placed on the stockpile plan.

DRAINAGE REPORTS

MINIMUM STANDARDS

- A. For all Drainage Reports, provide as required for the level of detail for each type of Drainage Report described in section 4-1.500:
 1. Analysis based on:
 - a. HEC-1, HEC-HMS, HEC-2 or HEC-RAS, FlowMaster, HY-8, Culvert Master and/or
 - b. DDMSW; or
 - c. Nonstandard software, if approved by city staff, and if working nonstandard software is provided.
 2. Two bound copies (3 ring, GBC or coil wire, no staples), with card stock front and back covers.
 3. Information to conform to generally accepted engineering principles and practices to allow city staff to assess whether the Drainage Report meets city standards.
 4. Off-site topography, with 1- or 2-foot contours based on a current survey, to delineate watershed boundaries.
 5. Cross sections necessary to adequately demonstrate how structures on the site are not subject to inundation during a base flood and how the proposed site grading will not adversely affect other property. Current color aerial photographs:
 - a. On-site, minimum 400 scale aerial photos, clearly identifying project site.
 - b. Off-site, minimum 800 scale aerial photos, showing project site in context.
 6. On-site and off-site photographs as necessary to support parameter selection.
 7. Sufficient detail to allow thorough review.
 8. A full size, 24-inch x 36-inch watershed delineation map. Show 1- or 2- foot contours and elevations, drainage basins, drainage flow arrows, concentration points and watershed boundaries. Show calculations to quantify the flows for the 2, 10, and 100-year, storm events. State the method used to quantify the flows. Show the flow lines, inverts, existing SD systems, existing flow rates, historical entry and exit locations for discharge. Every item on the map shall be easily readable and labeled.
 9. Completed and signed Warning and Disclaimer of Liability. See App. 4-1C in this Chapter.
 10. Full size plans/maps, folded, contained in pockets and listed in the Table of Contents.
 11. A CD, DVD, secure flash drive, or secure portable hard drive containing the entire Drainage Report, including all Chapters, Figures, Attachments, Maps and Appendices, all in Portable Document Format (PDF), with data files of analysis required above. The media shall be labeled and include the engineer's name, firm name, project name, date, and Plan Check Number and/or Case Number. The CD or DVD shall be in a case and the media shall be placed in the separate folder in the Drainage Report. The media shall also contain all hydrologic and hydraulic input and output files such as HEC-1 and HEC-RAS.

DRAINAGE REPORTS

MINIMUM STANDARDS

- B. For all Drainage Reports, provide:
1. Title Page:
 - a. Type of Report (Conceptual, Preliminary, Final or Master Plan).
 - b. Project Name.
 - c. Location.
 - d. COS Plan Check Number and/or Case Number.
 - e. Engineer's seal, signature, and date, in accordance with AZBTR requirements.
 2. Table of Contents:
 - a. List of All Chapters, Figures, Attachments, Plans, Maps and Appendices.
 - b. Engineer's seal, signature, and date.
 3. Introduction:
 - a. Project Name, location, size and brief description (including scope of project).
 - b. Vicinity map.
 - c. Purpose and objectives of Drainage Plan.
 - d. Executive summary of findings, conclusions and proposals.
 - e. Special Conditions, if applicable, including project stipulations; erosion issues; 401 and 404 Permits; ADEQ Permits; Arizona Pollutant Discharge Elimination System (AZPDES) Permits; and stormwater storage waiver, wash modification and phasing proposals.
 4. Data Analysis Methods: Provide a narrative of pre- and post-development for on-site and off-site conditions:
 - a. Hydrologic procedures, parameter selection and assumptions. Hydraulic procedures, methods, parameter selection, design criteria and assumptions.
 - b. Stormwater storage calculation methods and assumptions, including accounting for sediment.
 - c. Basis for setting lowest floor elevations relative to designated floodplains and adjacent washes; or outside a floodplain, relative to highest adjacent grade.
 5. Conclusions.
 - a. Summarize the data analysis methods used.
 - b. State how the conclusions are reached.
 6. References and Appendices: Provide the following technical data to support the conclusions, based on the level of detail required for each type of Drainage Report described in section 4-1.500.
 - a. Data and calculations.
 - b. Peak flow calculations (e.g. Rational Method or HEC-1 printouts).
 - c. Channel design calculations including toe-down protection and drop structure design.
 - d. Culvert design calculations.
 - e. Floodplain calculations (e.g. Manning's and/or HEC-RAS printouts).

DRAINAGE REPORTS

MINIMUM STANDARDS

- f. Stormwater runoff calculations.
- g. Storage volume calculations.
- h. Retention/detention basin inflow outflow analysis and design calculations.
- i. Street capacity calculations.
- j. Curb opening, catch basin calculations.
- k. SD calculations.
- l. Sediment and scour calculations.
- m. Riprap sizing.
- n. Erosion/sediment control plan.
- o. Soils and or geologic analyses.
- p. Hydrologic and hydraulic data and calculations.
- 7. Different information and format:
 - a. Chapter 1 provides additional information and requirements for submittals.
 - b. City staff may require additional information, or information in a different form from that required above, to address unique situations or assist city staff in thorough review of the Drainage Report.
- C. For Conceptual Drainage Reports referenced in section 4-1.501(A), provide the documents required in A. and B. above with further specifications below:
 - 1. The Report must include the phasing information, including:
 - a. Graphic of areas to be phased, with labels of phases.
 - b. Justification for phasing.
 - 2. The Report must show and label, on separate pages, (1) pre-development, on-site and off-site, and (2) post-development, on-site and off-site:
 - a. Watershed and floodplain boundaries.
 - b. FEMA floodplain designations.
 - c. Dimensions and calculation of disturbed area.
 - d. Flow lines and flow rates; with dashed lines for flow lines of watercourse inverts or thalwegs.
 - e. Historical flow path entry and exit locations.
 - f. 100-year peak discharge rates at key concentration points.
 - g. Land use, building footprints, utilities and development conditions.
 - h. Drainage characteristics, network and patterns for existing watershed.
 - i. Location, description and purpose of existing and proposed drainage infrastructure; conveyance of off-site flows; connections to and probable effect on upstream and downstream drainage systems.
 - j. Existing drainage easements and rights-of-way, with the Maricopa County Recorder's number.
 - 3. Some Conceptual Drainage Report requirements may be waived if conditions warrant as determined by the Floodplain Administrator.

DRAINAGE REPORTS

MINIMUM STANDARDS

- D. For Preliminary Drainage Reports referenced in section 4-1.501(B), provide the documents required in A., B. and C. above with further information and specifications below:
1. FIRMs.
 2. Proposed waiver of any stormwater storage requirement.
 3. The Report must include the following descriptions and analysis:
 - a. Existing land use in the watershed area and proposed land use resulting from development.
 - b. Explanation of parameters of analysis used.
 - c. Basis of selection of lowest floor elevations.
 - d. Scour effects.
 - e. Proposed drainage infrastructure, including storage facilities design criteria, volume required ($V_R = XXX \text{ ft}^3$), volume provided ($V_P = XXX \text{ ft}^3$), and basin locations.
 - f. Management plans for operating and maintaining all drainage infrastructure.
 - g. Consistency with applicable ordinance requirements, standards, approved stipulations, General Plan (Land Use Element), Conceptual Drainage Report and Plan, Master Drainage Report and Plan, and other proposed developments affecting the site, including capital improvement projects.
 - h. Phasing information, including detailed graphic of areas to be phased, with labels of phases, and descriptions and analysis of all drainage Improvements to be constructed in each phase, timetables for each phase, impact of phased construction, and required interim drainage infrastructure. Each phase shall provide drainage infrastructure to serve that phase and create no adverse impact off-site.
 - i. Runoff from a base flood, and consideration of storm events more frequent than the base flood. Development shall not increase peak discharge rates above the historic peak discharge rate for any event up to and including the base flood.
 - j. Modeling results of flow peak discharge rates, velocities and routes.
 - k. Stormwater storage facility design elements, including volume required, volume provided and drain times.
 - l. Watercourse cross-sections, including flow rate, water surface elevation, velocity and top width.
 - m. Size, capacity and nature of off-site drainage infrastructure entering and exiting the project site.
 - n. Impact of development on project site and future development within fifty feet of project site.
 4. Regional drainage plans related to adjacent properties.
 5. Some Preliminary Drainage Report requirements may be waived if conditions warrant as determined by the Floodplain Administrator.

DRAINAGE REPORTS

MINIMUM STANDARDS

- E. For Final Drainage Reports referenced in section 4-1.501(C), provide the documents required in A., B., C. and D. above with further specifications below:
1. Certification that all applicable local, state and federal permits have been obtained.
 2. Notice of Intent, SWPPP and ADEQ checklist, as approved by ADEQ, as applicable.
 3. Proposed drainage easement agreements, including legal descriptions, title commitments and confirmation of easements signed by lienholders.
 4. Certification:
 - a. The plan relies on accurate figures and analysis.
 - b. The plan meets all applicable requirements and standards. The plan reflects all elevations based on NAVD 88 and meet the FEMA Benchmark Maintenance (BMM) criteria. See the criteria defined within the Coordinator's Manual of the National Flood Insurance Program Community Rating System. Use the MCDOT benchmark system in accordance with the BMM criteria.
 - c. The plan is consistent with approved stipulations and the Preliminary Drainage Report and Plan.
 - d. All structures are safe from flooding.
 - e. The development shall have no adverse impact on-site or off-site.
 5. The Report must include the following descriptions and analysis:
 - a. Location of all on-site and off-site culverts, with number, material, size of pipes, and upstream and downstream invert elevation labels.
 - b. How topographic changes from the project affect drainage characteristics, including time of concentration.
 - c. Whether model was developed with subcritical, supercritical or mixed flow analysis.
 - d. Methods to address any erosion issues consistent with DSPM requirements.
 - e. Existing land use and Green-Ampt soil characteristics for the site, including USDA NRCS soil survey maps.
 - f. Phasing information, including detailed timetables for each phase, and demonstrated compliance with applicable stipulations.
 - g. An appendix addressing city review comments, with cross-references to the revised Plan.
- F. For Master Drainage Reports referenced in section 4-1.501(D), provide the documents required in A., B. and C. above with further specifications below:
1. Plans to a minimum scale of 1" = 100' are recommended, but they must be legible as determined by city staff.
 2. The Report must include the descriptions and analysis of all drainage improvements to be constructed in each phase, the impact of phased construction, and required interim drainage infrastructure.

DRAINAGE REPORTS

MINIMUM STANDARDS

3. The Plan must show and label, pre- and post-development, on-site and off-site:
 - a. Existing land use in the watershed area, and modified land use resulting from proposed development.
 - b. Size, capacity and nature of off-site drainage infrastructure entering and exiting the project site.
 - c. All drainage improvements to be constructed in each phase and required interim drainage infrastructure.
4. Some Drainage Report requirements may be waived if conditions warrant as determined by the Floodplain
- G. For all Grading and Drainage Plans, provide as required for the level of detail for each type of Plan described in section 4-1.500:
 1. Information for the entire project site and off-site at least 25 feet from the site.
 2. Topography, based on current surveys, as follows:
 - a. For topography on site and 25 feet beyond the property line, where practicable, as well as any area subject to a hydraulic model, show existing and proposed topography with 1-foot contours, with 5-foot contour lines distinguished for readability. Exceptions may be considered on a case-by-case basis for substantial areas of undisturbed ground not subject to inundation in a base flood.
 - b. Subject to city staff approval, show spot elevations in lieu of 1-foot contours for development that does not have enough relief to use 1-foot contours.
 - c. All proposed contours must align with all existing contours.
 - d. Topographic surveys shall be based on a topographic survey prepared and certified by an Arizona professional civil engineer or registered land surveyor based on an actual field survey performed within a year of the submittal and with a level of accuracy of 3 inches and verifiable to within 3 inches of existing conditions.
 3. A full size, 24-inch x 36-inch pre-development site plan. Show and label all the basic elements of a Grading and Drainage Plan including flow rates, flow lines, existing storm drainage infrastructure and all existing easements. Show and label the on-site drainage basins and within each basin show the pre-development Q2, Q10 and 100-year peak discharge in channel or wash (Q100) for each historical runoff entry and exit location. Show and label concentration points.
 4. A full size, 24-inch x 36-inch post-development site plan. Show and label all the basic elements of a Grading and Drainage Plan including: existing and proposed contours or elevations, flow rates, flow lines, existing storm drainage infrastructure and all existing easements Show and label the on-site drainage basins and within each basin show the pre-development Q10 and

DRAINAGE REPORTS

MINIMUM STANDARDS

- Q100 for each historical runoff entry and exit location, show and label concentration points. Use drainage flow arrows to show direction of runoff.
5. Flood Elevation (RFE) = the HAG Elev. + depth of flooding + 1 foot of freeboard. The LF88 must be at or above the RFE.
 6. In local floodplains and special flood hazard areas, for all structures, show the lowest floor elevation, lowest elevation of mechanical equipment and attendant utilities, BFE, BFD, highest and lowest adjacent grade, and, if applicable for commercial structures, floodproofing elevations. If the lowest floor is below the base flood elevation, submit the design for protecting the interior of the structure. For calculating the BFE in Flood Zone A, see FEMA Publication 265: Managing Floodplain Development in Approximate Zone A
 7. Areas – A Guide for Obtaining and Developing Base (100-year) Flood Elevations at www.fema.gov/media-library.
 8. Existing walls showing top of wall elevations.
 9. Watercourse cross-sections to show that the watercourse has adequate capacity and freeboard to convey runoff through the site.
 10. The Plan must show and label, pre- and post-development, on-site and off-site:
 - a. Existing and proposed property lines and, for existing properties, assessor's parcel numbers.
 - b. COS Plan Check Number and/or Case Number for adjacent development that has occurred in the last 5 years.
 - c. 2, 10- and 100-year peak discharge rates at all entry and exit locations, and flow concentration points.
 - d. Location of proposed drainage infrastructure, including storage facilities and, related to adjacent properties, existing drainage infrastructure.
 - e. Watercourse cross-sections, including flow rate, water surface elevation, velocity and top width.
 - f. Size, capacity and nature of off-site drainage infrastructure entering and exiting the project site.
 - g. Proposed drainage easements, including easements over watercourses with a 100-year peak discharge rate of 25 cfs or greater (50 cfs within ESL zoning district), showing the limits of the easement.
 - h. Upon city staff request, spot elevations.
 11. Some Preliminary Grading and Drainage Plan requirements may be waived if conditions warrant as determined by the Floodplain Administrator.
- H. For Final Improvement Plans and Grading and Drainage Plans referenced in section 4-1.501(C), provide the documents required in A. and C. above with further specifications below:
1. Flood Elevation = the HAG Elev. + depth of flooding + 1 foot of freeboard. The LF88 must be at or above the RFE.
 2. In local floodplains and special flood hazard areas, for all structures, show the lowest floor elevation, lowest elevation of mechanical equipment and

DRAINAGE REPORTS

MINIMUM STANDARDS

- attendant utilities, BFE, BFD, highest and lowest adjacent grade, and, if applicable for commercial structures, floodproofing elevations. If the lowest floor is below the base flood elevation, submit the design for protecting the interior of the structure. For calculating the BFE in Flood Zone A, see FEMA Publication 265: Managing Floodplain Development in Approximate Zone A
3. Areas – A Guide for Obtaining and Developing Base (100-year) Flood Elevations at www.fema.gov/media-library.
 4. Existing walls showing top of wall elevations.
 5. Watercourse cross-sections to show that the watercourse has adequate capacity and freeboard to convey runoff through the site.
 6. The Plan must show and label, pre- and post-development, on-site and off-site:
 - a. Existing and proposed property lines and, for existing properties, assessor's parcel numbers.
 - b. COS Plan Check Number and/or Case Number for adjacent development that has occurred in the last 5 years.
 - c. 2, 10- and 100-year peak discharge rates at all entry and exit locations, and flow concentration points.
 - d. Location of proposed drainage infrastructure, including storage facilities and, related to adjacent properties, existing drainage infrastructure.
 - e. Watercourse cross-sections, including flow rate, water surface elevation, velocity and top width.
 - f. Size, capacity and nature of off-site drainage infrastructure entering and exiting the project site.
 - g. Proposed drainage easements, including easements over watercourses with a 100-year peak discharge rate of 25 cfs or greater (50 cfs within ESL zoning district), showing the limits of the easement.
 - h. Upon city staff request, spot elevations.
 7. Some Preliminary Grading and Drainage Plan requirements may be waived if conditions warrant as determined by the Floodplain Administrator.
 - I. For Final Improvement Plans and Grading and Drainage Plans referenced in section 4-1.501(C), provide the documents required in A. and C. above with further specifications below:
 1. Plans in a recommended scale of 1" = 20', which must be legible as determined by city staff. These plans must show grade breaks and flow arrows.
 2. One-foot topographic contours based on a current conditions certified field survey for the entire development site to 25 feet beyond the property line and for off-site areas where a hydraulic model is necessary.
 3. The Plan must meet standards for improvement plans, complete with detailed engineering and construction notes. The Plan must show and label pre- and post-development, on-site and off-site:
 - a. Drainage sub-basins.

DRAINAGE REPORTS

MINIMUM STANDARDS

- b. Limits of inundation for all watercourses with a 100-year peak discharge rate greater than 25 cfs (50 cfs within ESL zoning district).
 - c. 2, 10-year and 100-year peak discharge rates for all washes entering and exiting the site, with intermediate locations of 10-year and 100-year peak discharge rates within the site at least 1 time per sheet per wash, at confluences and points of interest such as culverts, SDs, utility crossings, and channel improvements, shown with a directional arrow in the following format: Q2/Q10/Q100 = XX/XX/XX cfs.
 - d. All existing and proposed walls, and top and base of wall elevations at wall ends, changes in elevation, and as required by city staff.
 - e. Utilities labeled by type.
 - f. Easements labeled by type, such as drainage, water, sewer, access, public utility, sidewalk and natural area open space.
 - g. Dimensions, capacities, materials, cross-sections and typical details of proposed drainage infrastructure.
 - h. Location and elevation of the nearest benchmark in NAVD 88, or subject to city staff approval, a local benchmark with an elevation equation related to NAVD 88, to nearest hundredth of a foot.
- J. Some Grading and Drainage Plan requirements may be waived if conditions warrant as determined by stormwater staff.

GRADING & DRAINAGE PLANS

ADDITIONAL REQUIREMENTS BY PLAN TYPE

The following requirements are in addition to the above requirements depending on the type of plan or development. Some requirements may apply to other plan types depending on the nature of the project and improvements.

A. Commercial, Industrial and Multifamily

The plan must show:

1. The location, orientation and an outline of refuse enclosures, including approach slabs.
2. Details of driveways conforming to city standard details, plus existing gutter grades at tie in, longitudinal slopes, the location of grade breaks, sidewalk ramps, curb return radii, existing curb and asphalt removal and asphalt replacement.
3. Horizontal control for proposed buildings, drive aisles, parking space dimensions and any other substantial improvements.
4. High and low points for driveway paving, with elevations.
5. Building setback lines.
6. Traffic and parking striping.
7. Access to underground parking areas.

B. Residential Subdivisions

The plan must show:

1. Lot numbers.
2. Tract names and street names from the final plat.
3. Street, tract and right-of-way widths, and street centerlines from paving plans.
4. Street longitudinal and cross slopes.
5. 10-year and 100-year peak discharge rates at curb cuts and catch basins.
6. Flow path for small watercourses or swales through lots in custom residential subdivisions.
7. High and low points within streets, with elevations.
8. Building setback lines.
9. Top of curb elevations at the intersection of lot lines with the tract or right-of-way lines.

C. Custom Single Family Residential

Requirements for single-family development can be found at

www.scottsdaleaz.gov/planning-development/sfr-process

For custom single family residential grading and drainage plans prepared for lots or parcels not having existing pregraded building pads, the plan shall include two perpendicular scaled cross sections taken through the proposed residence/structure with horizontal and vertical scales provided. The sections shall show existing and proposed topography and all proposed improvements, and 100-year water surface elevations for 50 cfs or greater washes.

GRADING & DRAINAGE LANGUAGE

WARNING AND DISCLAIMER OF LIABILITY

The City’s Stormwater and Floodplain Management Ordinance is intended to minimize the occurrence of losses, hazards and conditions adversely affecting the public health, safety and general welfare which might result from flooding. The Stormwater and Floodplain Management Ordinance identifies floodplains, floodways, flood fringes and special flood hazard areas. However, a property outside these areas could be inundated by floods. Also, much of the city is a dynamic flood area; floodways, floodplains, flood fringes and special flood hazard areas may shift from one location to another, over time, due to natural processes.

WARNING AND DISCLAIMER OF LIABILITY

The flood protection provided by the Stormwater and Floodplain Management Ordinance is considered reasonable for regulatory purposes and is based on scientific and engineering considerations. Floods larger than the base flood can and will occur on rare occasions. Floodwater heights may be increased by constructed or natural causes. The Stormwater and Floodplain Management Ordinance does not create liability on the part of the city, any officer or employee thereof, or the federal, state or county government for any flood damages that result from reliance on the Ordinance or any administrative decision lawfully made thereunder.

Compliance with the Stormwater and Floodplain Management Ordinance does not ensure complete protection from flooding. Flood-related problems such as natural erosion, streambed meander, or constructed obstructions and diversions may occur and have an adverse effect in the event of a flood. You are advised to consult your own engineer or other expert regarding these considerations.

I have read and understand the above.

Plan Check #

Owner

Date

ISOPLUVIALS

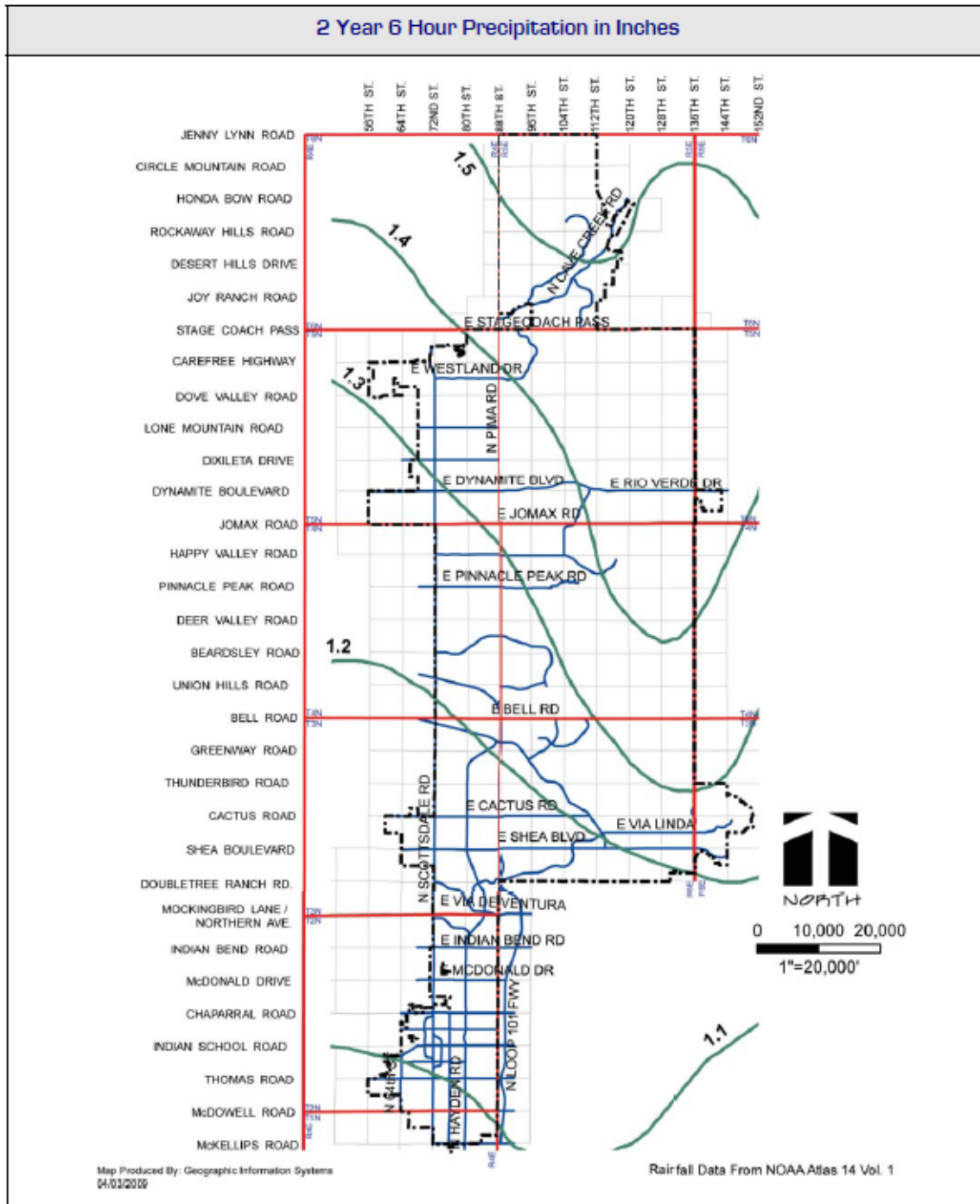

ISOPLUVIALS

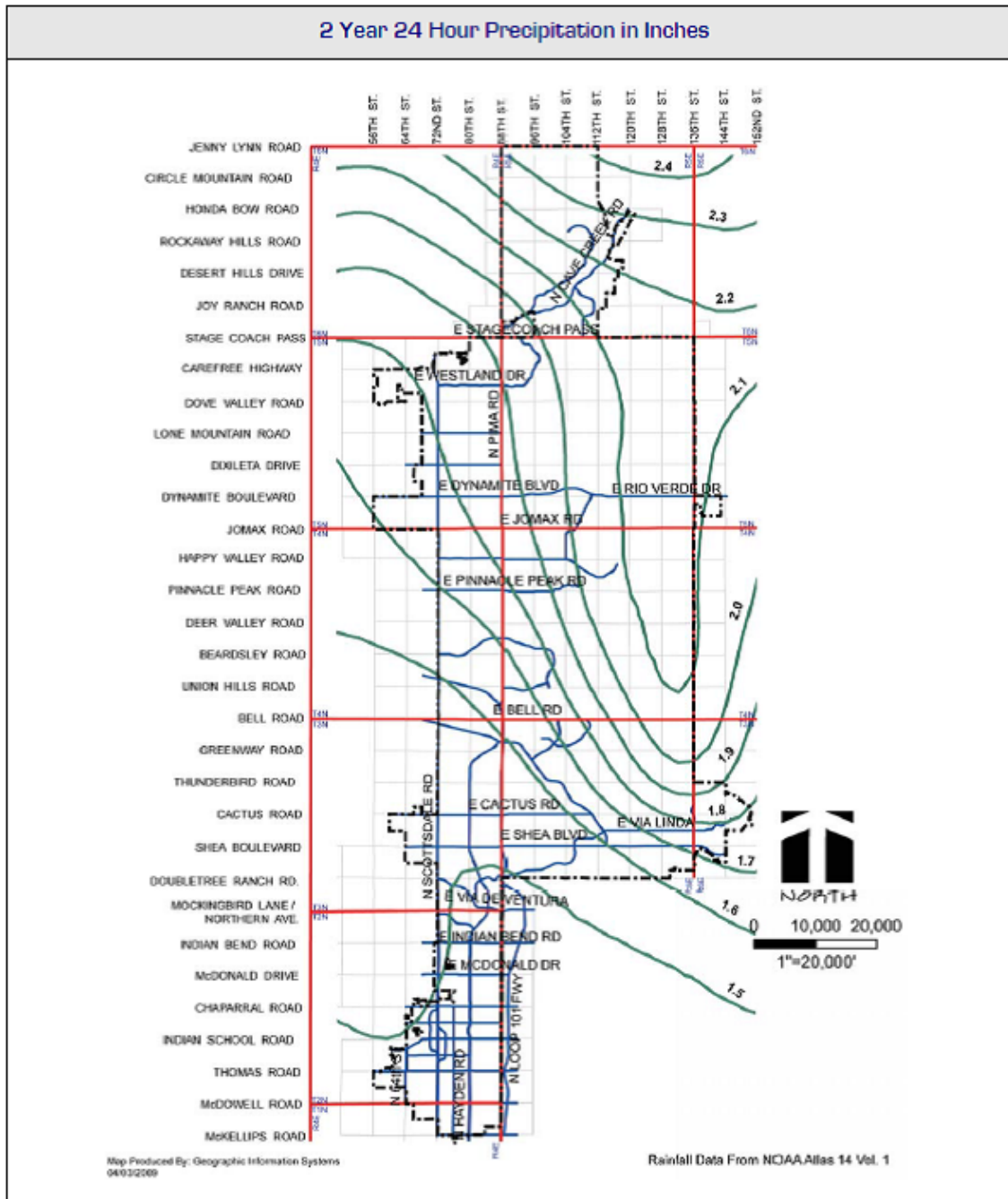

ISOPLUVIALS

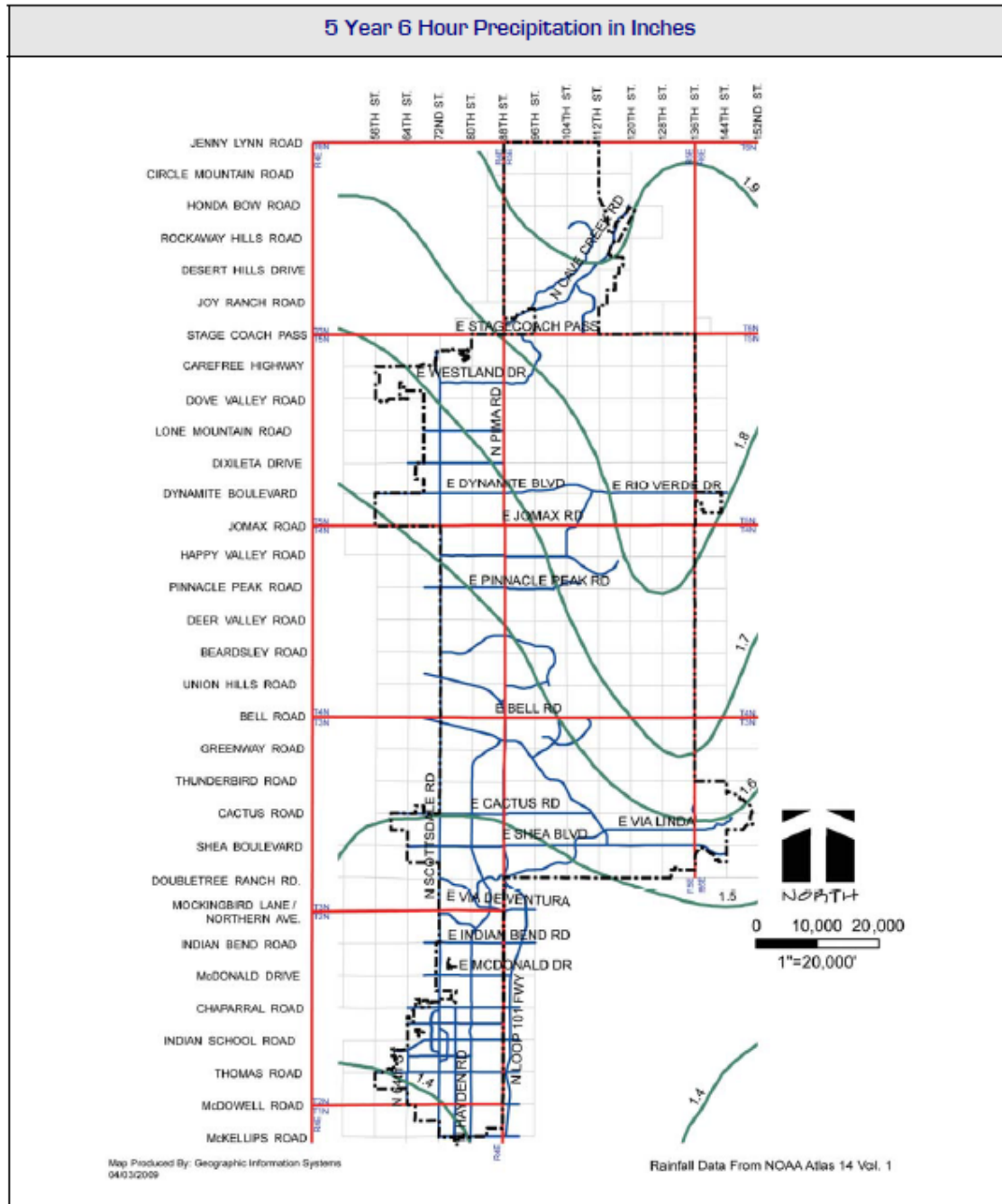

ISOPLUVIALS

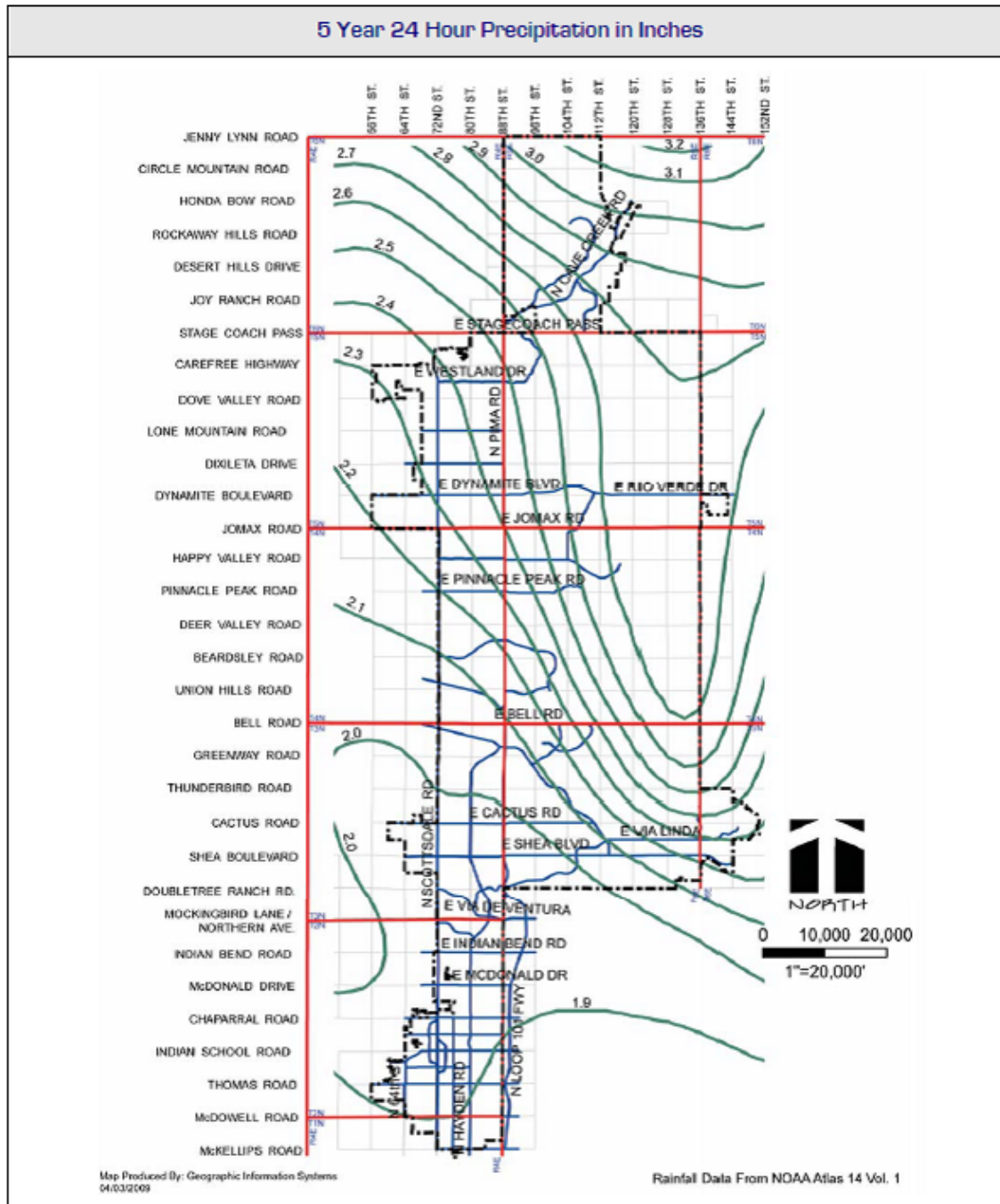

ISOPLUVIALS

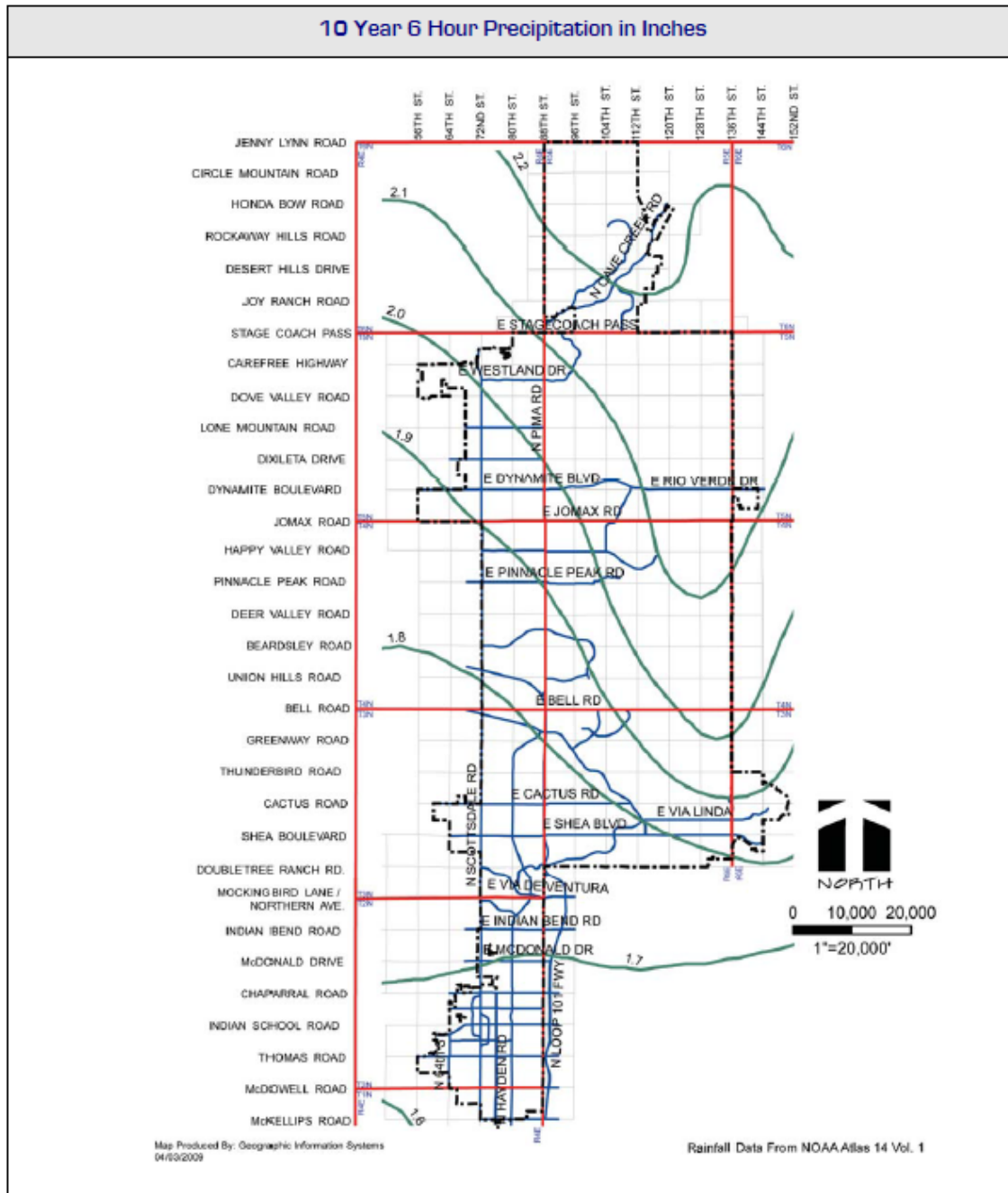

ISOPLUVIALS

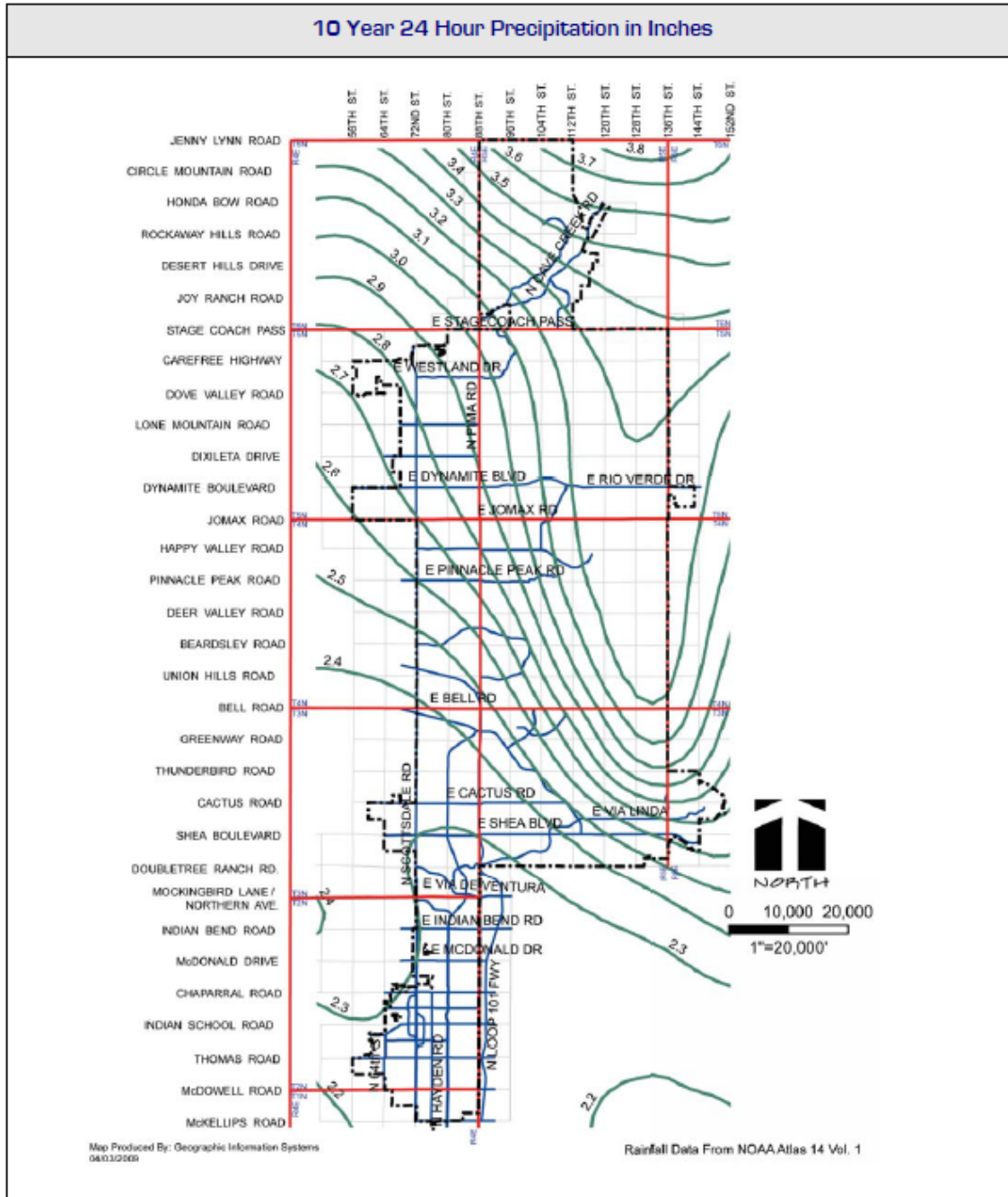

ISOPLUVIALS

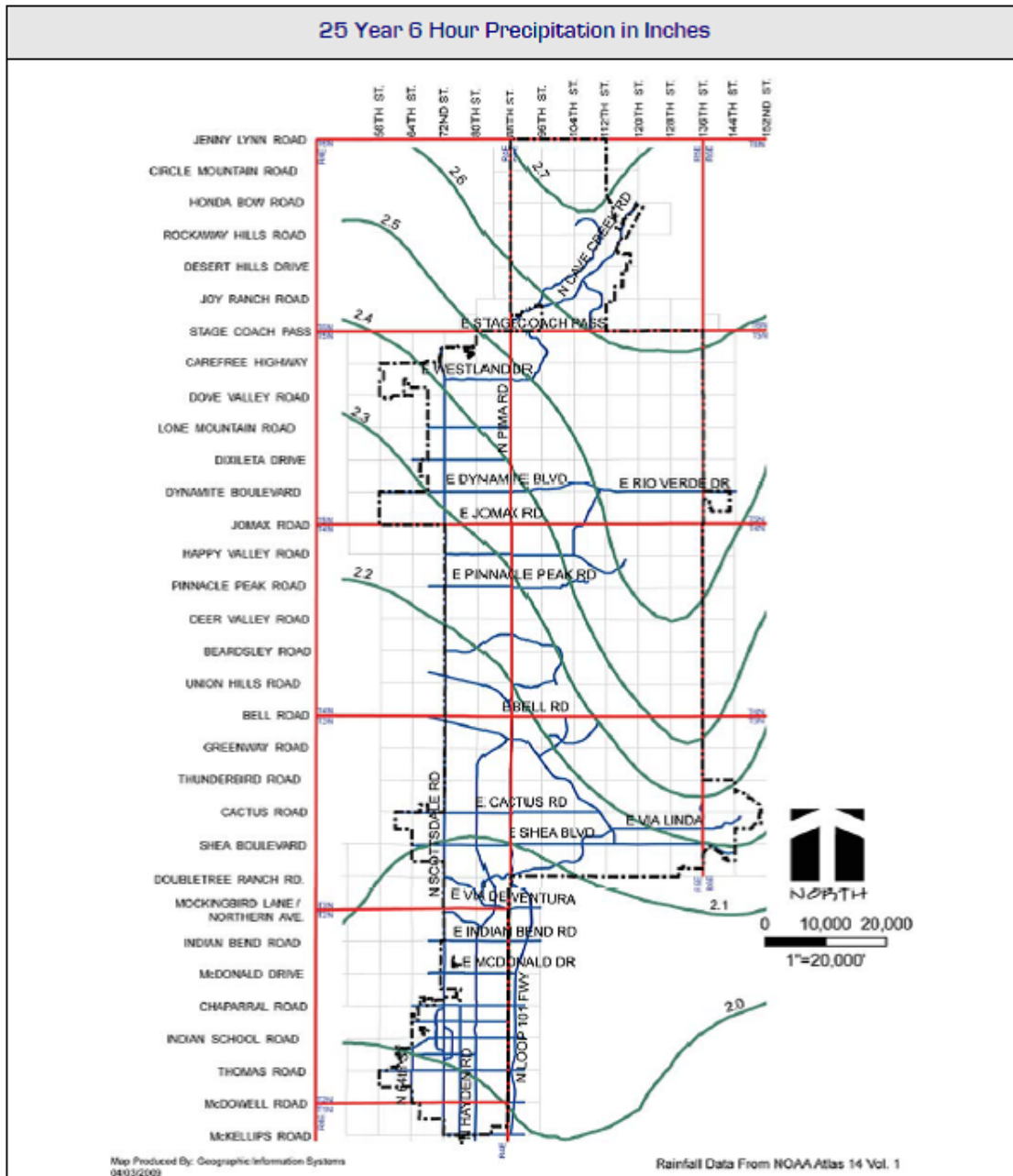

ISOPLUVIALS

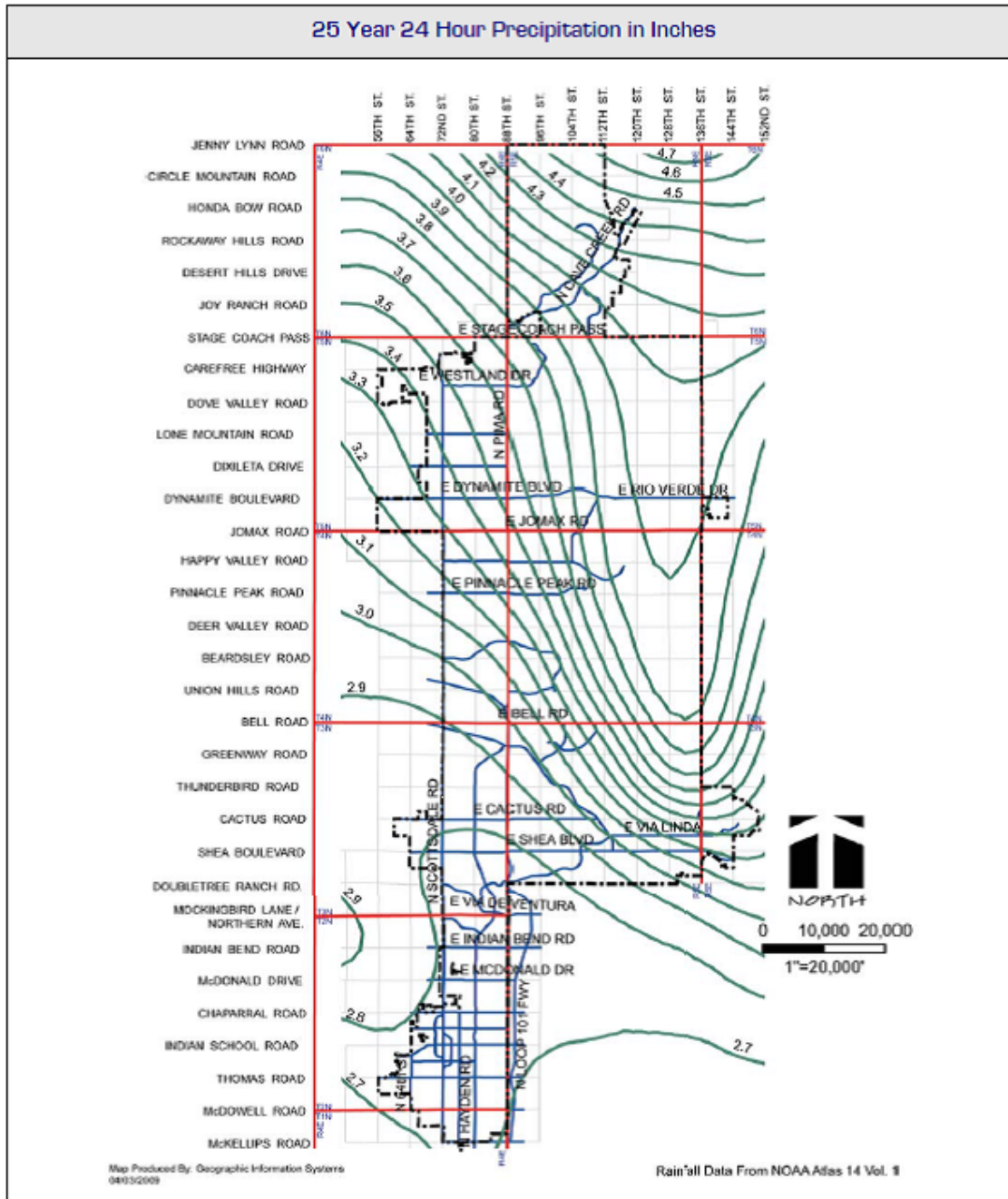

ISOPLUVIALS

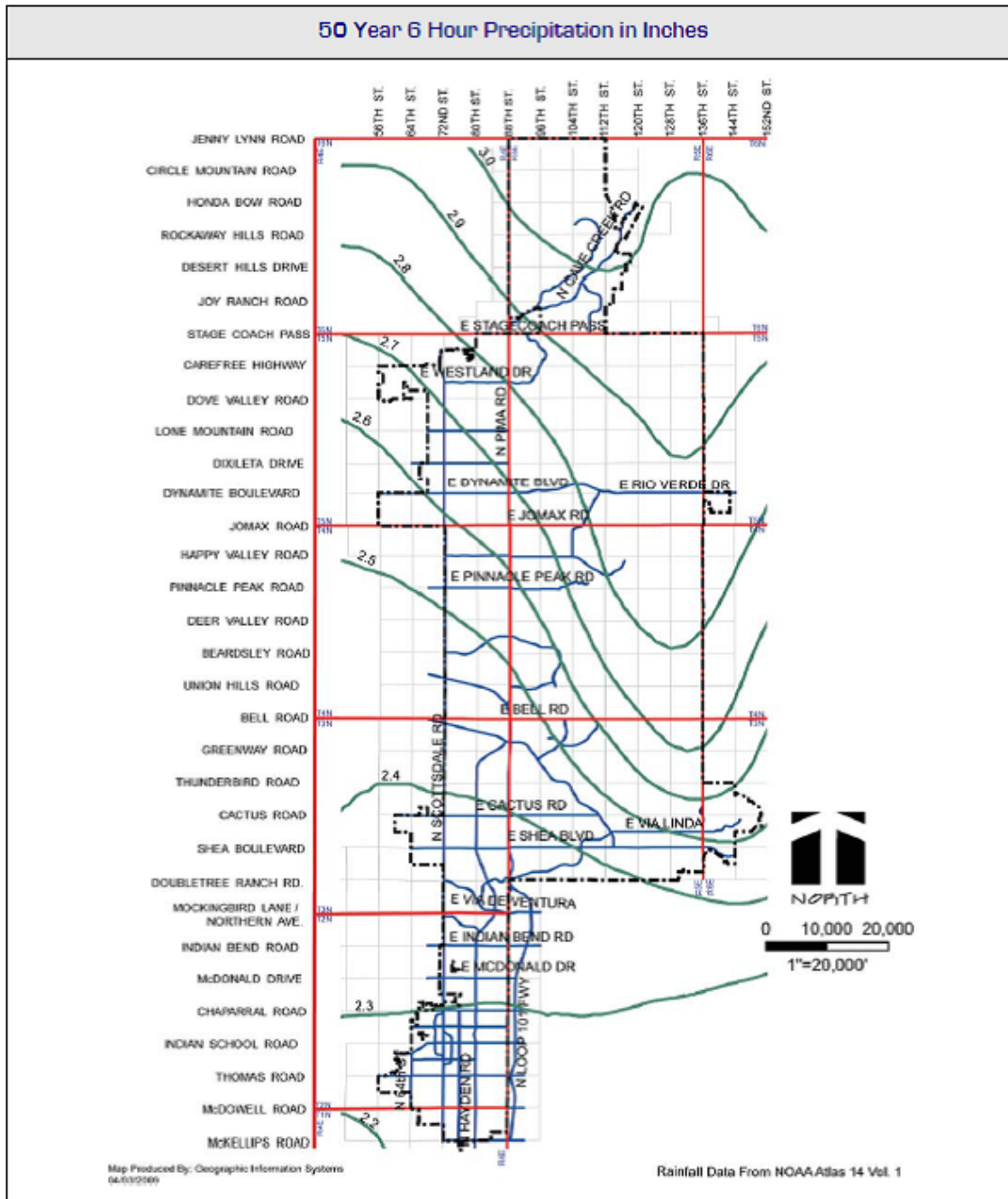

ISOPLUVIALS

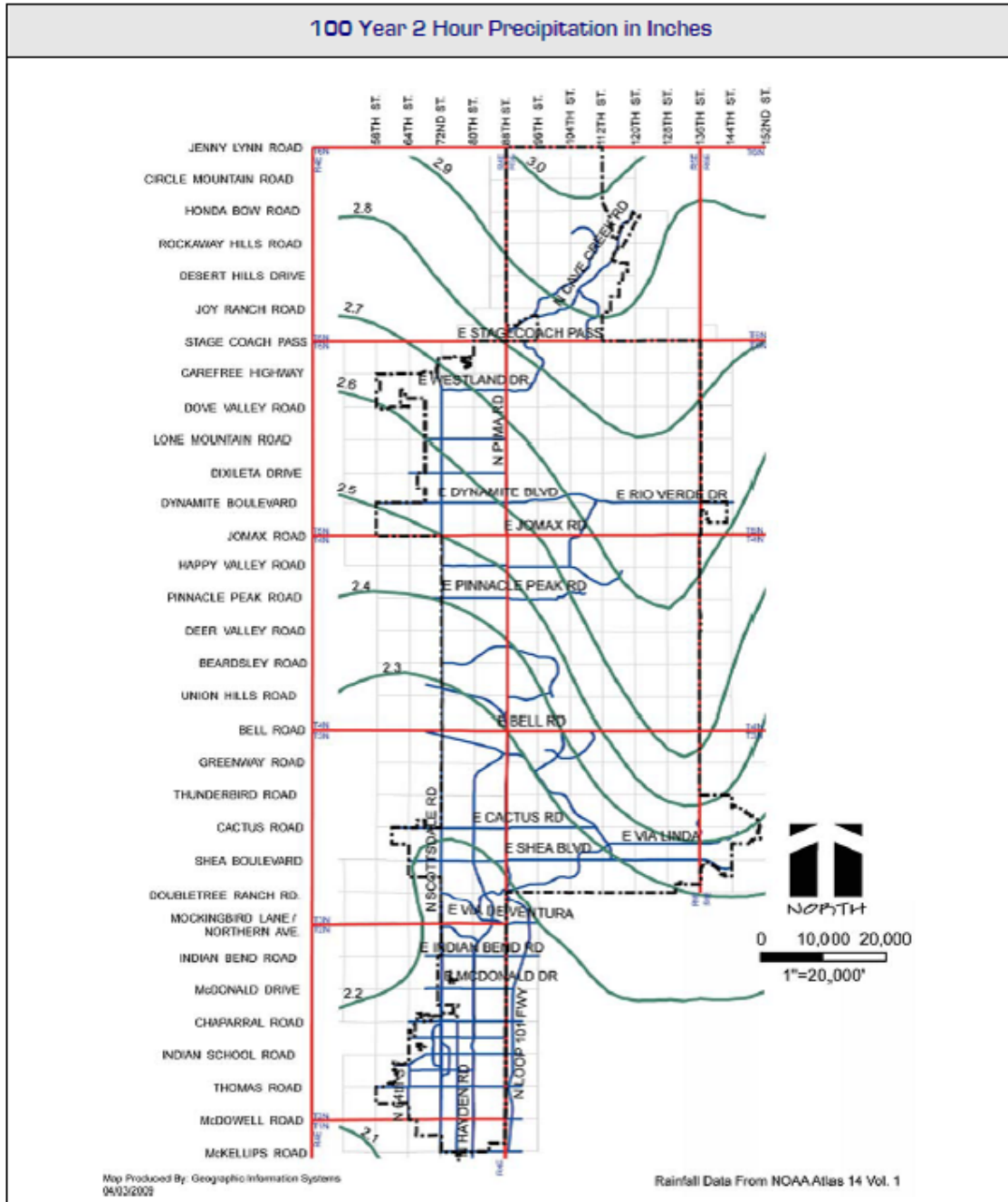

ISOPLUVIALS

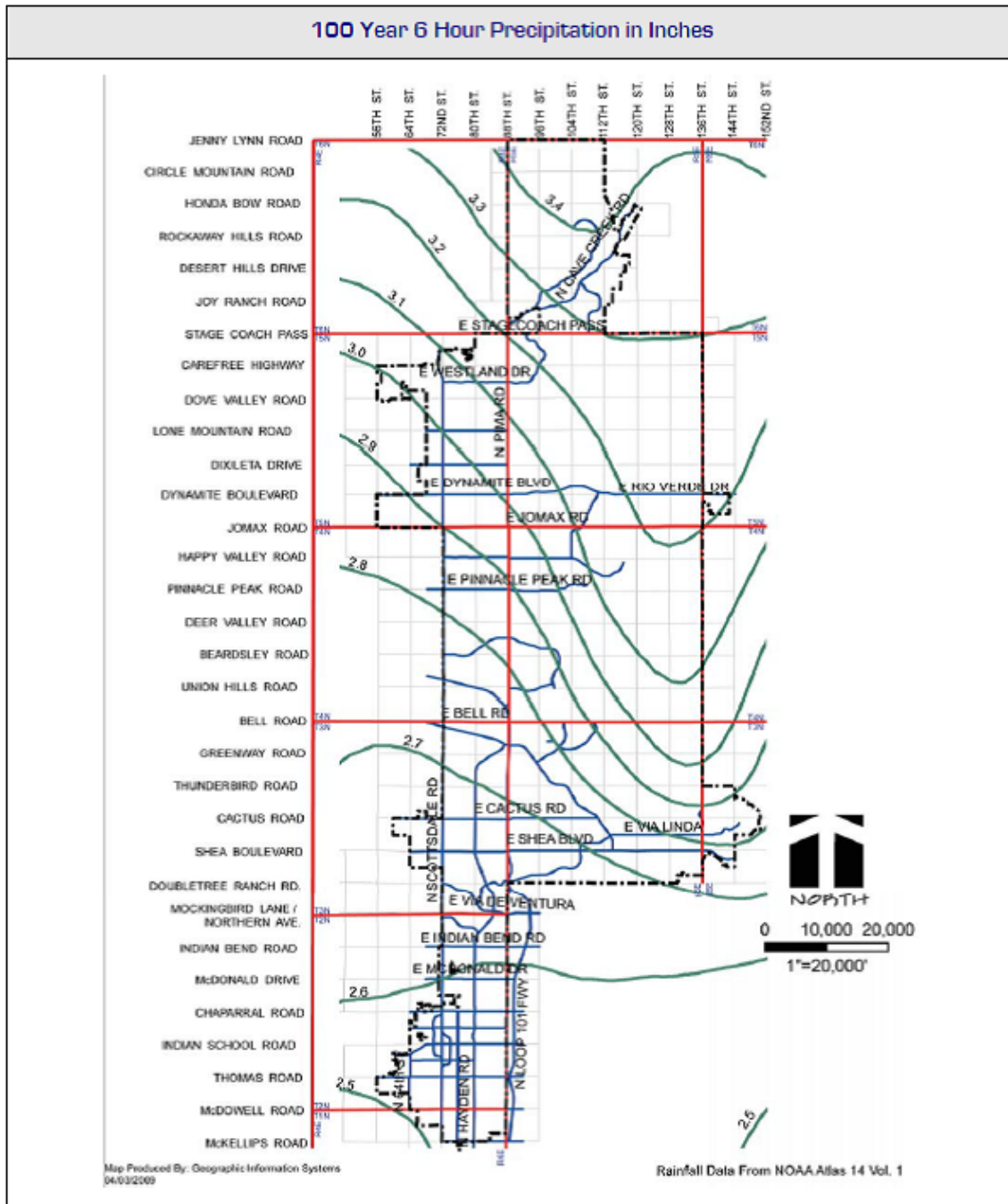

ISOPLUVIALS

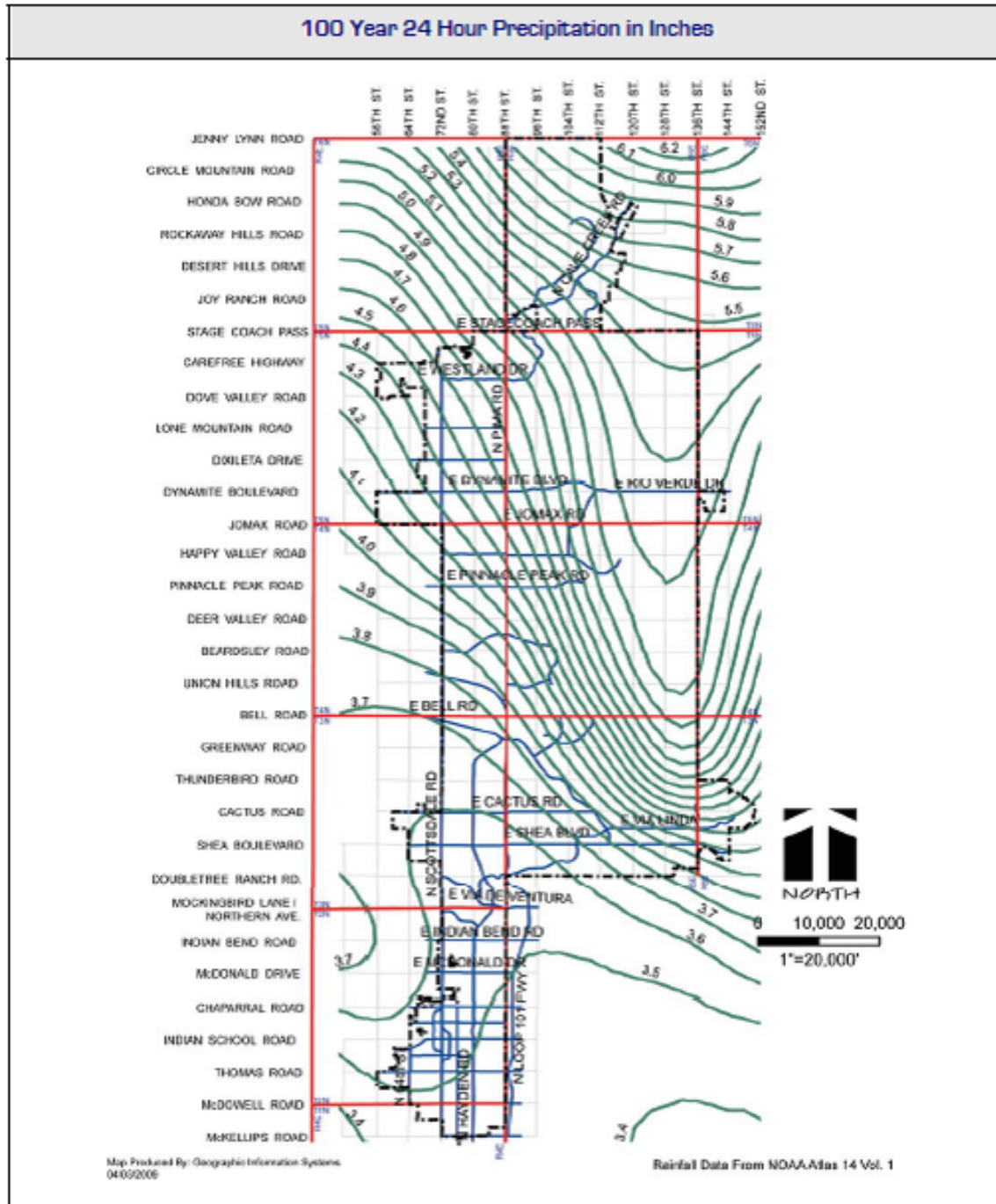

Chapter 5

TRANSPORTATION

5

This chapter provides minimum design criteria for planning, designing, and preparing final plans for modifying and constructing transportation facilities within the city. It addresses traffic impact analysis, rights-of-way considerations, street geometrics, traffic signal design, signs and markings, transit amenities, bikeways, pedestrian facilities, neighborhood traffic management, flexible pavement design and streetlighting.

5.1 TRANSPORTATION IMPACT STUDY

5-2 RIGHTS-OF-WAY MANAGEMENT

5-3 GEOMETRICS

5-4 TRAFFIC SIGNAL DESIGN

5-5 SIGNS & MARKINGS

5-6 TRANSIT

5-7 BIKEWAYS

5-8 PEDESTRIAN FACILITIES

5-9 NEIGHBORHOOD TRAFFIC MANAGEMENT

5-10 FLEXIBLE PAVEMENT DESIGN

5-11 STREET LIGHTING

Section 5-1

TRANSPORTATION IMPACT STUDY

5-1

A Transportation Impact & Mitigation Analysis (TIMA) may be required for a General Plan Amendment, a zoning map amendment, or a use permit (UP) application. This section presents the analysis process and requirements for completing a TIMA and report to determine needed modifications to the existing and planned transportation system as a result of proposed development.

GENERAL INFORMATION

5-1.000

A. Major Issues Addressed in Transportation Analysis

The TIMA document will address issues as:

1. The current transportation system and operational characteristics in the site vicinity,
2. The interface between the on-site circulation system and the adjacent circulation system,
3. The intensity and character of the development,
4. Trip generation,
5. Distribution and assignment estimates, and
6. Capacity and Safety impacts of the proposed development on the existing and planned transportation systems.

B. Study Timing

A TIMA may be required for a General Plan Amendments, zoning district map amendment, or a conditional UP application. The need for, and extent of, the study shall be based on the criteria described in this guide and any analysis provided in previous applications. All studies shall be submitted in final form concurrent with the development application for which it is a component.

C. Study Preparation Process

The study preparation process should include open discussions between the applicant, study consultant, and City of Scottsdale (city) staff. Therefore, discussion regarding the TIMA should begin prior to when the application for the development is submitted, not after a development plan is finalized and a traffic study is completed. This will ensure that the objectives of both the land owner/developer and the city can be met.

At the pre-application meeting, issues and process will be determined and discussed at a joint meeting with a team of Planning and Transportation staff members. This team will determine if any at-large regional issues are affected by the proposal. After the pre-application meeting, at the applicant or their consultant's request, Transportation staff will meet to discuss the parameters of the TIMA or provide a scope of work for the study. Once the project application is submitted, the amount of interaction between the applicant and their consultant with city staff may be limited by current State Law.

After the TIMA document is completed, it will be submitted to the city for review with the project application. The document will be reviewed for completeness and compliance with TIMA Guidelines. If the document is determined to be complete, Transportation staff will conduct a thorough review of the document and prepare a summary report of the findings of this review. This summary and a copy of the TIMA document will be included in the staff report for the case. Minor revisions may be suggested before the project is scheduled for public hearing.

D. Presentation of the Study Results

The TIMA consultant shall attend all public meetings and public hearings held in association with the proposed development to present the results of the study and any assumptions used in the preparation of the study. The applicant shall be

responsible to ensure that the consultant is notified and present at these meetings. If the consultant is not in attendance, the case may be continued to a future hearing.

INITIATING IMPACT AND MITIGATION ANALYSIS

5-1.100

A. Pre-application Meeting

The procedures outlined herein present the minimum information required to determine the level of traffic analysis that will be required. The purpose of the pre-application conference is to provide guidance and direction to the applicant concerning the nature and extent of the analysis. Failure by the applicant to provide these items may result in delay in completion of an acceptable TIMA. At a minimum, the following items must be provided for staff review:

1. Vicinity map,
2. Current aerial map,
3. Summary of existing building or development on the site – examples: existing building area and land use, current zoning, approved site plan, previous zoning history, etc.,
4. Preliminary summary of proposed development by land use – examples: building area, number of employees, leasable tenant space, acreage, etc.,
5. Proposed site plan, and
6. Market analysis, if available.

B. Warrants for Studies

Proposed projects will fall into one of three categories for purposes of transportation impact and mitigation analysis. The first category is proposed projects that are deemed to have insignificant traffic impacts. The second category is projects that have localized impacts to the city's transportation system. The third category is proposed developments that have significant impacts to the transportation system that may extend beyond the vicinity of the site. For those situations where it is questionable as to which category is appropriate, the Transportation Director, or their designee, will make the final determination. The Transportation Director also has the authority to waive the requirement for a traffic impact analysis for unusual situations that fall outside of the following guidelines or where the analysis is deemed to be unnecessary based on previous studies or current traffic conditions.

"Existing, allowed land use" will be interpreted as development that is allowed under the city's current zoning and General Plan designation. Development may be restricted to previously approved site plans and development programs where prescribed by zoning stipulations. For those situations where it is questionable as to what level of development is allowed on the site, the Zoning Administrator will make the final determination.

C. Scope of Work

After the pre-application meeting, Transportation staff will provide a scope of work for the traffic impact and mitigation analysis based upon the development proposal and site location. This scope will outline the extent of the analysis that is expected to be provided by the consultant at the initial stage of the project

conception; additional information may need to be provided or evaluated as the development proposal becomes more defined or is modified, or if additional issues are identified through the public outreach process. Studies that are submitted to the city that do not conform to the minimum scope of work provided may be returned to address deficiencies, which may impact the hearing schedule for the application.

CATEGORY 1

5-1.101

- A. If a proposed development is anticipated to generate less daily trips than it would under the existing allowed land use or generates less than 100 vehicle trips per hour in the “peak period on the adjacent street system,” a transportation impact and mitigation analysis is not necessary. In some cases where the change in land use or daily trip generation is significant, a study may be required as determined by the Transportation Director. The following sizes of different land use classifications are deemed to generate less than 100 trips in the peak hour and therefore do not require any analysis:
1. < 100 residential dwelling units
 2. < 6,000 gross square feet retail
 3. < 25,000 gross square feet office
 4. < 100,000 gross square feet industrial
 5. < 160 hotel / motel / resort rooms
 6. < 30,000 gross square feet medical office
- B. For a development application that falls under this category, the applicant will be required to submit a Traffic Statement prepared by a registered professional engineer that includes the following:
1. Site plan,
 2. Adjacent street volumes, and
 3. Trip generation comparison to the existing land use or previously approved development under current zoning.

CATEGORY 2

5-1.102

- A. If a proposed development is anticipated to generate more daily trips than it would under the existing, allowed land use, and generates less than 500 vehicle trips per hour in the “peak period on the adjacent street system,” then a Category 2 study is required to determine the extent of the transportation impacts of the proposed development.
- B. For a development application that falls under this category, the traffic analysis will include the following:
1. Site plan,
 2. Adjacent street volumes,
 3. Crash history,
 4. Trip generation comparison to the existing land use or previously approved development under current zoning, and
 5. Level of service analysis of roadway segments and intersections adjacent to or within one-quarter mile of the site.

- C. The following considerations are some of the development and transportation system characteristics that will be evaluated in determining the extent of the study area and the need for additional or expanded analysis such as a traffic signal warrant analysis.
 - 1. Current traffic volumes and level of service on the adjacent streets,
 - 2. Driveway location and volume,
 - 3. Collision data on adjacent street segments and at nearby intersections, and
 - 4. Special conditions and circumstances to the development or the transportation system.

CATEGORY 3

5-1.103

- A. If a proposed development is anticipated to generate more daily trips than it would under the existing, allowed land use, and generates more than 500 vehicle trips per hour in the “peak period on the adjacent street system,” then a Category 3 study is required to determine the extent of the transportation impacts of the proposed development.
- B. For a development application that falls under this category, the traffic analysis will include the following:
 - 1. Site plan,
 - 2. Adjacent street volumes,
 - 3. Crash history,
 - 4. Trip generation comparison to the existing land use or previously approved development under current zoning,
 - 5. Level of service analysis of roadway segments and intersections adjacent to the site
 - 6. Level of service analysis of major roadway segments and intersections near the site, and
 - 7. Safety performance assessment of intersections within the vicinity of the site unless otherwise directed by the Transportation Director.
- C. The following considerations are some of the development and transportation system characteristics that will be evaluated in determining the extent of the study area and the need for additional analysis, such as neighborhood traffic mitigation.
 - 1. Current traffic volumes and level of service on the adjacent streets,
 - 2. Driveway location and volume,
 - 3. Proximity to and potential impact upon nearby residential areas,
 - 4. Collision data on adjacent street segments and at nearby intersections, and
 - 5. Special conditions and circumstances to the development or the transportation system.

EXTENT OF STUDIES

5-1.200

CATEGORY 2 STUDY

5-1.201

- A. This study will include the following:
 - 1. A site plan with proposed access points;

2. An area map showing the surrounding transportation system, including the locations of the signalized intersections within 1 mile of the nearest signalized intersection on adjacent streets in all directions;
 3. Most recent crash rates and rankings on adjacent roadway segments and intersections within the study area;
 4. Current traffic volumes on the street system within the study area;
 5. Trip generation;
 6. Trip distribution;
 7. Traffic assignment;
 8. Existing levels of service on adjacent roadways, including site access driveways and adjacent signalized intersections and/or major un-signalized intersections and major intersections within 1 mile of the site may be included in the study area as determined by the Transportation Department;
 9. Levels of service for the opening year with and without the proposed development.
- B. The Category 2 study's purpose is to provide an analysis of existing and anticipated traffic conditions on the adjacent transportation system and identify potential concerns that may need additional analysis or need to be mitigated.

CATEGORY 3 STUDY

5-1.202

A complete TIMA analysis will be required for any proposed development that is anticipated to generate more than 500 trips in the peak hour of the adjacent street. The type and extent of analysis required for a complete TIMA analysis will depend on the development under consideration and its potential impact on the study area transportation network. Large developments with regional impacts will require extensive analysis and sophisticated computer modeling applications; smaller developments might only require manual trip distribution and assignment techniques.

The study area for a Category 3 study will be the roadway segments and signalized intersections within 1 mile of the site that meet the following traffic conditions:

- A. Intersections with entering volumes that currently exceed 40,000 vehicles per day (vpd), or
- B. Intersections with approach volumes in the design year that are increased by 5% or more, as a result of the traffic generated from the proposed development.

The city will determine the extent of the Category 3 study including intersections to be evaluated and horizon years.

CONTEXT & FRAMEWORK

5-1.300

EXISTING CONDITIONS

5-1.301

The reports for either a Category 2 or Category 3 study will provide current approach volumes for 24 hours of a typical weekday, and turning movement volumes in 15 minute intervals for the time periods of 7:00 to 9:00 a.m. and 4:00 to 6:00 p.m., for all intersections of streets that are classified as major collector (rural, suburban, or urban), minor arterial (rural, suburban, or urban), major arterial (rural, suburban, or urban), or

freeway in the study area. Twenty-four-hour typical weekday volumes should also be provided for adjacent roadway segments. The results of a level-of-service analysis, for the peak hour periods in the morning and in the evening for the existing conditions, will be included in the report. The report will also list the crash rate, frequency, and severity for all intersections and roadway segments in the study area for the most recent available year.

HORIZON YEAR(S)

5-1.302

For a Category 2 study, the traffic analysis will be based on traffic conditions for the build-out or completion year of the development. In some cases, staff may require an additional horizon year if there are significant changes anticipated to the surrounding infrastructure or traffic volumes.

For a Category 3 study, the traffic analysis will be based on traffic conditions for the build-out or completion year of the development, and a minimum 5-year projection from the anticipated build-out date, which may be rounded up to the closest and 5-year increment (2015, 2020, and 2025, etc.) If the project is a large, multi-phased development, the initial horizon year will be the date that corresponds to the opening of the first major phase of development. In some cases, staff may require an additional horizon year for multi-phase projects or projects with significant changes anticipated to the surrounding infrastructure or traffic volumes.

The study will provide morning and evening peak hour approach and turning movement volumes for each intersection in the study area for the required horizon years. Level-of-service analyses for these peak hour conditions, without the site traffic and with the site traffic, will be included in the report.

PEAK TRAFFIC HOUR(S)

5-1.303

The report will analyze the peak traffic periods on the adjacent street system during the morning and evening, peak hour periods. The report will also analyze the peak traffic periods for the development, should these periods occur at different times or on different days from the peak periods of the adjacent street system.

BACKGROUND STUDY AREA DATA

5-1.304

The City of Scottsdale Traffic Engineering Division (STED) prepares a traffic volume and crash data report for every even-numbered year. This information will be available to the traffic-engineering consultant. The consultant will use the most recently available data, at a minimum. If data from earlier years is deemed pertinent, the consultant may utilize it to supplement the most recent data.

The City of STED periodically obtains traffic volume information at various locations. This information will be available to the consultant. The consultant may not use traffic volume data older than 15 months as current information. However, it may be utilized for supplemental purposes. If traffic volume data more recent than 15 months is not available, then the developer is responsible for obtaining the information directly.

The City of Scottsdale Transportation Planning Division prepares traffic volume projections for 5-year increments. This information will be available to the consultant. However, the information will need to be reviewed by the consultant for applicability to the TIMA. Adjustment and recalculation may be necessary. If the proposed

development is very large in terms of anticipated traffic generation or in terms of deviation from the Scottsdale General Plan, comprehensive traffic projection modeling may be necessary.

REVIEW OF ANTICIPATED OFF-SITE CHANGES

5-1.305

The Transportation Department will provide copies of TIMAs prepared for previous proposed developments that may be pertinent to a current analysis. The city will also provide other transportation related reports that may be of assistance. The consultant will be responsible for reviewing these reports and incorporating their data, conclusions, and recommendations where appropriate.

The consultant will be responsible for obtaining copies of the current Circulation Element of the General Plan for the city and the Transportation Master Plan and adhering to the policies and guidelines contained in both documents.

FIELD RECONNAISSANCE AND DATA COLLECTION

5-1.306

If current traffic volume data is not available, the consultant will be responsible for obtaining traffic volume data in accordance with the requirements of the study, as stated previously. The consultant must also obtain speed limit information and analyze sight distance availability and requirements. The Transportation Planning Division will provide information regarding bicycle and transit facilities near the site of the proposed development. The consultant will be responsible for incorporating the needs of these facilities into the analysis and report.

NON-SITE TRAFFIC FORECASTS

5-1.400

A. Components of Non-Site Traffic

Estimates of non-site traffic are required for a complete analysis of horizon-year conditions. These estimates represent the “base” conditions, that is, without the site development.

B. Methodology

There are two principle methods of projecting off-site traffic that are acceptable: use of area-wide modeled data, and trends or growth rates. Each method has its appropriate use depending on the availability of data and the size of the proposed development.

In most cases, modeled data will be available from the Transportation Department. In those cases where this data is not available, the city will determine if the data needs to be produced for an adequate analysis, or if a trends analysis will suffice.

C. Analysis of Future Conditions

Future traffic demand estimates are developed by adding the estimated site generated traffic, all approved (or potential) development in the area, and current traffic volumes adjusted for general growth in the area. The consultant will determine the levels of service in the study area based on the non-site traffic for the horizon-year.

SITE TRAFFIC FORECASTS

5-1.500

GENERAL PROCEDURE

5-1.501

The potential traffic impacts of a planned development are forecast for the projected conditions in the horizon year(s) of the project. The first step in the process is trip generation.

The trip generation process provides an estimate of the number of trips that will be generated due to the new development. Generally, the trip generation process consists of applying trip rates or equations for different types and sizes of land use development to the proposed land uses in the development to determine the total number of new trips added to the system. Trip generation will be calculated for the a.m. and p.m. peak hours and the daily period.

SOURCES

5-1.502

The sources from which trip generation rates are taken are extremely important in assuring an accurate estimate of the impacts of a proposed development. In general, whatever the source, it is important to establish that the trip rate for a given land use is representative of the proposed development land use. Such items as size, location, services, and number of studies should be considered before using any data source.

A. State and Local Data Sources

In most cases, assuming a similar number of studies, local trip generation rates will be more accurate for predicting the trip generation of the development proposal. If such data is available, it should be reviewed with city staff to determine its applicability to the site.

B. National Data Sources

Trip Generation Manual, published by the Institute of Transportation Engineers (ITE).

ITE trip generation rates can be used as a starting point in estimating the amount of traffic that may be generated by a specific building or land use. Whenever possible, or when the number of studies on which the rate is based is limited, the ITE rates should be adjusted to reflect local conditions. The ITE rates should be used with the application of sound judgment.

C. Collection of Additional Data

If it is determined that a local rate is most appropriate, but existing local data samples are limited, the consultant will be required to collect additional local data to provide a credible sample size on which to base the trip generation estimate.

Local trip generation data should be collected at sites that exhibit similar characteristics to the development being studied and that are self-contained, with adequate parking not shared by other activities. The consultant should follow the guidelines contained in the most recently published ITE's Trip Generation Handbook: An ITE Recommended Practice.

SELECTION OF TRIP GENERATION RATES OR EQUATIONS

5-1.503

Selection of trip generation rates or equations should be performed according to the guidelines constrained in the most recently published ITE's Trip Generation Handbook: An ITE Recommended Practice.

CHOOSING THE APPROPRIATE TIME PERIODS

5-1.504

The range of average rates for different time periods will be examined to determine when the generator peaks in traffic flow and to define the relationship between the peak generation and the peaking characteristics of the adjacent street system. When the peak hour of the generator does not correspond to either the a.m. or p.m. peak hours of the adjacent street system, that additional time must be analyzed to determine site-specific design requirements (such as auxiliary lane storage lengths).

DAILY AND SEASONAL VARIATIONS

5-1.505

Trip generation estimates for the average weekday are appropriate analyses for most, but not all, land uses. For some land uses, more trips are generated on Friday or Saturday than on the average weekday. Those days, rather than the average weekday, may be the most appropriate design or analysis period for those uses.

Seasonal variations are also important for some land uses. As a prime example, shopping centers should be analyzed for the period between Thanksgiving and Christmas, which is traditionally the busiest shopping season. For recreational and hotel land uses the consultant must provide an analysis that adjusts the background traffic to replicate the appropriate peak season of the generator. Seasonal adjustment factors are available from the Transportation Department.

DRIVEWAY TRAFFIC VS. TRAFFIC ADDED TO ADJACENT STREETS

5-1.506

It is usually assumed that all trips entering and exiting a new development are new trips that were not made to or through the area prior to the development being completed. However, for some non-residential developments, a portion of these trips may be "captured" from trips already being made to other existing developments on the adjacent street system, or they may be merely passing by on the way from one place to another. The driveway volume for a new development may, therefore, be significantly different from the amount of traffic added to the adjacent street system. For example, retail establishments, restaurants, banks, service stations, and convenience markets attract people from the passing stream of traffic; these are known as pass-by trips.

ITE's Trip Generation Handbook contains discussions and references on the issue of pass-by trips. Because of the limited data available, adjustments for pass-by trips should be applied carefully. If pass-by trips are a major consideration, studies and interviews at similar land uses must be conducted or referenced.

MULTI-USE PROJECTS

5-1.507

Most trip generation rates and equations have been gathered at and apply to isolated single-use developments. When multiple uses are combined into one development, simply adding the single-use estimates together can result in a total trip generation estimate that is too high.

While trip rates and equations are available for shopping centers, little data exists for other multi-use projects such as downtowns, suburban mixed-use centers, or planned unit developments. Some national publications, such as National Cooperative Highway Research Program (NCHRP) Report 684, may provide data that can be useful in some cases.

Multi-use projects are another case in which any adjustments should be applied carefully because of the limited amount of data available. If this is a major consideration for the proposed development, an analysis should be performed to determine the number of trips that would be external for single uses, but which would be internal in a proposed mixed-use development. Trip Generation Handbook provides some information on this subject.

SPECIAL OR UNUSUAL GENERATORS

5-1.508

Occasionally, a development proposal will consist of special or unusual land uses for which typical trip generation rates or equations are not available, or simply do not apply. Judgment must be applied to identify a land use or combination of land uses that best represent the trip-making characteristics of the site. The reasoning and data used by the consultant in developing a trip generation estimate for a special or unusual generator must be justified and explained in the report.

SITE TRAFFIC DISTRIBUTION AND ASSIGNMENT

5-1.600

DISTRIBUTION METHODS

5-1.601

- A. The directions from which traffic will access the site can vary depending on many factors, including:
 1. The type of proposed development and the area from which it will attract traffic,
 2. The presence or absence of competing developments within the same market area,
 3. The size of the proposed development, and
 4. The conditions on the surrounding street system.
- B. The influence area of the development needs to be identified for the site. Ideally, the influence area should contain approximately 80% of the trip ends that will be attracted to the site. If a market study is available, it should be used in establishing the influence area. Otherwise, an influence area should be established based on a reasonable documented estimate.
- C. The three most common methods for estimating trip distribution are by analogy, model, and surrogate data. In most cases, a surrogate data method can be utilized for developing the trip distribution. Utilizing this procedure involves using socioeconomic and demographic data to establish population or employment land use distributions around the site. In most cases, population can be used as the basis for estimating distribution of office, retail, and entertainment trips; employment is a reasonable surrogate for residential trips; and other trips can be similarly distributed using logical surrogates. For horizon years, land use estimates based on the city's General Plan should be utilized.

For some very large-scale developments, a trip distribution model should be utilized to estimate site trip distribution. The gravity model portion of the city's traffic forecasting model is available for this purpose.

TRIP ASSIGNMENT AND PASS-BY TRIPS

5-1.602

A. Types of Trips

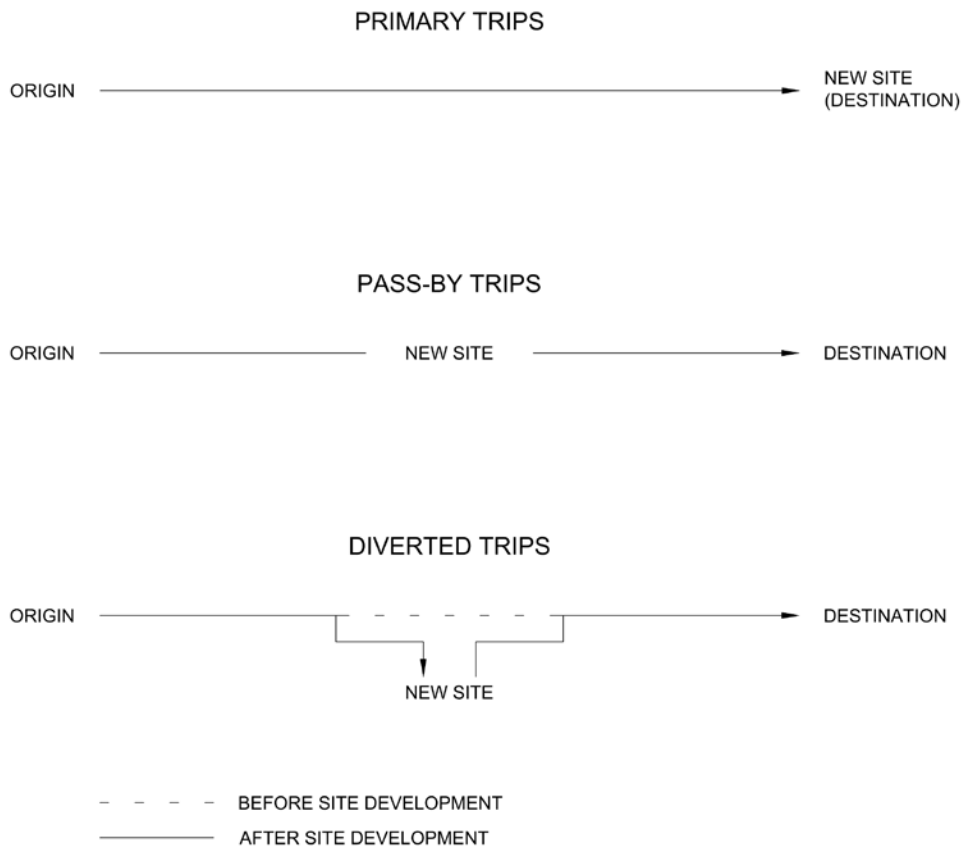

FIGURE 5-1.1 TYPES OF TRIPS

- B. After trip distribution is completed, trip assignment is used to determine the amount of traffic that will use certain roadway links within the influence area. The product of the trip assignment process is the total project-generated trips, by direction and turning movement.
- C. Trip assignment should be made considering logical routings, available roadway capacities, left turns at critical intersections, and travel times. The assignment should also reflect the horizon year(s), roadway, and land use conditions at that time.
- D. As discussed in Section 5-1.600, many land uses do not generate only vehicle trips that are entirely new to the roadway network. A portion of their trips may simply be diverted from trips already on adjacent or nearby streets. Because of limited data and research in pass-by trips, a thorough analysis is required if pass-by trips are to be accounted for in the study. The following procedure will be used:
 1. For the peak hour being analyzed, determine the percentage of pass-by trips as part of the total trip generation. The basis for this estimate should be

documented. Split the total trip generation number into a new trip amount and a pass-by trip amount.

2. In addition to estimating a normal trip distribution (for new trips), estimate a trip distribution for pass-by trips (considering the commuting work trip).
3. Perform two separate trip assignments, based on the two distributions. One assignment applies to pass-by trips; the other assignment applies to new trips. Care must be taken, as the pass-by trip assignment is more complicated. Pass-by assignment percentages should not automatically be applied to 2-way traffic, since an outbound pass-by trip may use a different route than an inbound pass-by trip. Also, due to the diversion concept, pass-by trip assignment involves subtracting trips from some existing traffic movements and assigning the trips to other movements.
4. Combine the numerical pass-by and new trip assignments. Remember the subtraction required on some vehicle movements because of diversion. Proceed to the analysis process.
5. Check the results for reasonableness. If pass-by trips diverted from a thoroughfare represent more than 15% of the traffic volume on the street, they should be re-evaluated.

REDEVELOPMENT PROJECTS

5-1.603

Since the purpose of the impact study is to evaluate a development proposal's impact on the transportation system, redevelopment projects require some special analysis. In the case of redevelopment projects, existing site-generated trips should be subtracted from existing and horizon year off-site traffic. The traffic generated by the proposed development is then added to the adjusted off-site traffic according to the above procedures to determine the impacts on the transportation system.

The consultant will establish the existing site generated trips through the collection of driveway counts. If the redevelopment area is substantial, or for some other reason does not lend itself to the collection of driveway counts for this purpose, trip generation rates may be applied to establish the existing site generated trips.

ANALYSIS

5-1.700

This section describes the analytical techniques used to derive the study findings, conclusion, and recommendations. As new methodologies are developed and validated, they may be considered by the city or the consultant for applicability to the study requirements.

Capacity analysis must be performed at each of the major street and site access intersection locations (signalized and unsignalized), as well as transportation links, located within the study area. In some cases, there may be a need to analyze additional critical intersections or segments located outside the basic study area. In addition to capacity analysis, several other transportation service-related factors shall be considered, including:

- A. Safety
- B. Circulation patterns
- C. Traffic control needs

- D. Transit needs or impacts
- E. Transportation system management
- F. Neighborhood impacts
- G. On-site parking adequacy and off-site parking facilities if any are to be used for site generated parking
- H. Pedestrian and bicycle circulation
- I. Service and delivery vehicle access and circulation

TOTAL TRAFFIC ESTIMATE

5-1.701

For each analysis period being studied, a projected total traffic volume must be estimated for each segment of the roadway system being analyzed. These projected total traffic volumes (consisting of site and non-site traffic) will be used in the capacity analyses. The traffic impact report must clearly depict the total traffic estimate and its components. Projected daily traffic volumes must be determined for all major streets within the study area as well.

GUIDELINES

5-1.702

Once the total traffic volume estimate has been established, capacity analyses will be performed. In some cases, the projected demand may be unrealistically higher than the capacity available on the existing or proposed transportation system components. In those cases where improvements are not feasible, an adjustment may be necessary in the site and/or background traffic to reflect realistic traffic diversion caused by capacity restraint. In such cases, the traffic components on all adjusted segments must be added again to obtain a more realistic total traffic projection. The original traffic estimates and specific reference to trip diversion shall be included in the report.

IDENTIFICATION OF IMPACTS, NEEDS AND COMMON DEFICIENCIES

5-1.703

The analysis is intended to show the relationship between the operations and geometry and to assess deficiencies, as well as to identify alternatives for further consideration. This requires the identification of impacts, needs, and deficiencies. The analysis of internal circulation, parking, off-site circulation, and capacity analyses will provide the basis for identifying transportation deficiencies and needs related to the proposed development. The analyses shall be conducted for conditions both with and without the proposed project to establish the incremental impacts of the project and the incremental needs it generates.

- A. The evaluation of traffic operating conditions is referred to as level of service (LOS). The assessment of LOS is based on the quantitative effect of factors, such as speed and volume of traffic, geometric features of the roadway or intersection, traffic interruptions and delay, and freedom to maneuver.
 - 1. Signalized Intersections
Signalized intersection level of service will be determined utilizing the methods contained in the Highway Capacity Manual (HCM), 6th Edition or most recent edition. Two methods (operational and planning) are provided for the analysis of signalized intersections.

The operational analysis requires detailed information on all prevailing traffic, roadway, and signalization characteristics. It provides for a full analysis of capacity and level of service and can be used to evaluate alternative traffic demands, geometric designs, signal plans, or all three. Because of the detailed data requirements, the operational analysis should be used only for the evaluation of existing conditions or for the analysis of projects with a horizon year of less than 5 years in the future. When critical variables are missing, it may be necessary to conduct a planning analysis. However, default values may be used for some of the variables without seriously compromising computations. Caution should nonetheless be used when applying such values and it must be used. The input data needs, with values that have been determined to be most appropriate for the city, are listed in Figure 5-1.1.

TYPE OF CONDITION	PARAMETER	SYMBOL	DEFAULT
Geometric Conditions	Area Type	Central Business District (CBD), Other	No default
	Number of Lanes	N	No default
	Average Lane Width, ft.	W	No default
	Grade, %	%G	0%
	Existence of Exclusive Left Turn (LT) or Right Turn (RT) Lanes	None	No default
	Parking Conditions	Yes, No	No parking
	Traffic Conditions	Volumes by Movement, vph	V
Ideal Saturation Flow Rate by Mov't, pcphgpl		S _o	2,000 pcphgpl (through lanes) 1,800 pcphgpl (turn lanes)
Peak Hour Factor		PHF	0.92
Percent Heavy Vehicles		%HV	2%
Conflicting Pedestrian Flow Rate, peds/hr		PEDS	None: 0 peds/hr Low: 50 peds/hr Mod: 200 peds/hr High: 400 peds/hr
Local Buses Stopping in Intersection		North Bound (NB)	0/hr
Parking Activity, pkg maneuvers/hr		N _m	20/hr (pkg exists)
Arrival Type (1-6)		AT	3 if isolated 4 if coordinated
Proportion of Vehicles Arriving on Green		P	
Signalization Condition	Cycle Length, sec	C	60-120 seconds
	Green Time, sec	G	No default
	Yellow Change Interval	Y	3.0 seconds
	All-Red Clearance Interval	AR	1.0 second
	Actuated or Pre-Timed Operation	A or P	Actuated
	Pedestrian Push-Button?	Yes, No	Yes
	Minimum Pedestrian Green	G _p	No default
	Phase Plan	None	No default

FIGURE 5-1.2 LEVEL OF SERVICE DEFAULT DATA

One of the most critical traffic characteristics that must be quantified to complete an operational analysis is the quality of the progression. The arrival

type is best observed in the field but could be approximated by examining time-space diagrams for the street in question. The arrival type should be determined as accurately as possible because it will have a significant impact on delay estimates and LOS determination.

The planning analysis only addresses capacity because it is not necessary or practical to perform detailed calculations of delay given the accuracy of the data that are generally available for planning purposes. The planning method generates two important products: (a) a projection of the status of the intersection with respect to its capacity, and (b) an approximation of a signal timing plan. Combining this approximation with appropriate values for other parameters used in the operational analysis, it is possible to extend the planning analysis into the level of the operational analysis.

The data requirements for the planning method are much less rigorous. Still, it is necessary to answer the following three questions to perform the analysis:

- a. Will parking be allowed?
- b. Will the signal be coordinated with the upstream signal on this approach?
- c. How will left turns be accommodated?

If the answers are not known to any of these questions, then the analysis should be completed and compared for each alternate condition, and a recommendation made as to the most desirable design conditions.

When analyzing permitted-protected, lagging left turn operation, contact the City of Scottsdale Traffic Management Center to discuss how to model the permitted-protected barrier structure.

2. Unsignalized Intersections

Unsignalized intersection level of service will be determined utilizing the methods contained in the HCM, 6th Edition or most recent edition. Procedures have been developed to analyze both 2-way stop controlled intersections and all-way stop controlled intersections. Each of these analysis methods is further divided into analysis of 4-way intersections and T intersections.

3. Roundabouts

Roundabout level of service will be determined utilizing the methods contained in the most recent version of the HCM or Rodel.

4. Arterials

In most cases, the capacity of an arterial street is dictated by the signalized intersections operating along its length. The analysis procedures described in the HCM rely on the results of the analysis methods above as a part of the input. Planning applications may use the entire arterial methodology, in a straightforward but somewhat simplified way, by computing stopped delay using certain default values as outlined in the signalized intersection analysis section. A reasonable estimation of the intended signal timing and quality of progression is vital to this process.

B. Capacity Analysis Software

Software that accurately replicates the HCM computations may be used in lieu of manual computations. Assumptions should be verified, as well as checking default

values. The consultant must verify that the city has access to the software that it intends to use, so that city staff may properly verify inputs and results.

SAFETY

5-1.704

A. Vehicles

The initial review of existing data within the study area shall include the crash experience for the past 3 years. This review should identify locations where roadways serving the site must be analyzed, and measures to alleviate crash hazards must be considered. Crash rates vary, but any intersection with more than one crash per million entering vehicles is worthy of additional analysis. Crash records can be obtained from the Transportation Department.

B. Pedestrians and Bicycles

The site plan should be reviewed to ensure that the internal circulation system and external access points are designed for pedestrian safety and to minimize vehicle/pedestrian conflicts. Locations for transit stops and their associated pedestrian flows to building access points require thorough assessment to ensure safety. Similarly, pedestrian flows to and from parking facilities need careful consideration during site planning, which often requires detailed information on the project's use and layout. These considerations should also be addressed for projects expected to generate significant bicycle traffic.

C. Safety Performance

The safety performance of signalized and unsignalized intersections evaluated in the capacity analysis shall be assessed for Category 3 traffic impact studies. Using the crash prediction methodology provided in the latest edition of the AASHTO Highway Safety Manual (HSM), average annual total crash frequency at each intersection shall be estimated for the following scenarios:

1. Existing traffic volumes and intersection configuration/conditions
2. Without project conditions for each horizon year using the same traffic volume and intersection configuration/condition as used for the without project capacity analysis
3. With project conditions for each horizon year using the same traffic volume and intersection configuration/condition as used for the project capacity analysis

Results shall be summarized in tabular form that includes a column indicating the percent difference in crash frequency without and with project.

The following assumptions shall be applied for predicting crash frequency using the HSM:

1. The calibration factor for both signalized and unsignalized intersections shall be 1.0 unless directed by the Transportation Department
2. Do not include observed crashes in the safety performance analysis unless directed by the Transportation Department. Only estimate the predicted crash frequency
3. If a K-factor is used to estimate daily volumes, it shall be consistent for all analysis scenarios

Tools available to perform the safety performance analysis include but are not limited to the following:

1. [AASHTO](#) Spreadsheets
2. Federal Highway Administration (FHWA) Interactive Highway Safety Design Model ([IHSDM](#))
3. Commercially available software that implements the HSM crash prediction methods.

FORMULATION OF MITIGATIONAL ALTERNATIVES

5-1.705

When the analyses indicate that a location is projected to operate at an acceptable level of service, no improvements are required. If, however, deficiencies are recognized, then improvements in access, geometry, or operations must be investigated. When reasonable improvements cannot sufficiently accommodate projected traffic, more detailed assessments of project size, land use, or development phasing may be required.

Many major projects necessitate improvements to the area's roadway infrastructure, both internally and externally. The nature of these improvements and their timing must be related to the anticipated phasing of the development, as well as the changes within the study area.

For redevelopment projects, mitigation alternatives will include transportation demand management measures, including, but not limited to transit, bicycle, and pedestrian improvements.

SITE ACCESS AND OFF-SITE IMPROVEMENTS

5-1.800

This section addresses site access and off-site improvements; and provides guidance. Judgment must be applied to assess alternative solutions and recommendations for site access and off-site roadway improvement requirements.

ESTABLISHMENT OF GOALS

5-1.801

- A. Study recommendations and conclusions are intended to provide safe and efficient movement of traffic to and from, within and past, the proposed development, while minimizing the impact to non-site trips.
- B. The following levels of service are required after the completion of each phase of the development, as well as completion of the entire project:
 1. All intersections and arterials must operate at LOS D (or better) during the peak traffic hour of the roadway system. All intersection approaches, and intersection turning movements should operate at LOS D (or better) and must operate at LOS E (or better) during the peak traffic hour of the roadway system. When the planning analysis is performed, the requirement will be that all intersections operate at "near capacity" or "under capacity."
 2. In areas where current levels of service, or future levels of service without the development, are E or worse, the delay or v/c ratio may not be significantly increased by the development traffic.
- C. If Safety Performance results show a 20% or higher increase in crash frequency at an intersection resulting from additional traffic generated by the proposed development, the Transportation Department may request additional countermeasures be evaluated and implemented to reduce crash potential.

RECOMMENDATIONS

5-1.802

- A. During the final phase of the study, all analyses are reviewed and re-assessed to best respond to the actual transportation needs of the project and the adjacent area. Results must be placed in logical perspective and sequence.
- B. In high-growth areas, particularly when large developments are being analyzed, it is important to determine the impact of individual phases of the development. This procedure becomes necessary in situations requiring assessments to fund improvements. In such cases, the following analyses steps should be completed:
 - 1. Levels of service under existing conditions.
 - 2. Levels of service for future horizon dates, with anticipated non-site generated traffic growth. Committed improvements should be included for each horizon year in the analyses. Additional improvements necessary to attain LOS D for base conditions should be identified.
 - 3. Levels of service including site generated traffic for horizon years, both with and without proposed additional improvements to local and regional roadways beyond those identified in step 2.
 - 4. Safety Performance for intersections identified in step 3.
- C. Network Improvements
Network improvements recognize that individual developments and increasing traffic volumes are part of the long-term growth of an area. Roadway improvements associated strictly with any given development may not necessarily address the long-term needs of the rest of the region on a systematic basis, and thus not address overall transportation system needs. Therefore, a section of the TIMA will address compatibility with the existing and planned infrastructure.
- D. Localized Improvements
Localized improvements consist of modification, expansion, and in some cases addition of roadway facilities in the immediate vicinity of the proposed development. The scope of these improvements will be consistent with the LOS criteria established above. They will address specific site and through traffic needs and will be compatible with the city's long-term improvement plans.
- E. Program Improvements
If adequate transportation improvements cannot be reasonably recommended, consideration should be given to reducing trip generation during problem periods by reducing the project magnitude or altering the land use mix.

IMPLEMENTATION SCHEDULE

5-1.803

It is important to view recommendations for improvements within appropriate time perspectives. Recommendations should be sensitive to the following issues:

- A. Timing of short-term and long-term network improvements that are already planned, scheduled, and/or funded.
- B. Time schedules of adjacent developments.
- C. Size and timing of individual phases of development.
- D. Rights-of-way needs and availability of additional rights-of-way within appropriate time frames.
- E. City priorities for transportation improvements and funding.

- F. Cost-effectiveness of implementing improvements at a given stage of development.
- G. Necessary lead-time for additional design and construction.

ON-SITE CIRCULATION

5-1.900

An integral part of an overall traffic impact study relates to basic site planning principles. It is extremely important that off-site roadway improvements be fully integrated with on-site recommendations. This section provides direction for on-site circulation.

APPROACH TO SITE PLANNING

5-1.901

Internal design will have a direct effect on the adequacy of site access points. The identification of access points between the site and the external roadway system, and subsequent recommendations concerning the design of those access points, is directly related to both the directional distribution of site traffic and the internal circulation system configuration. Driveway traffic volumes of varying sizes need to be accommodated on the site in terms of both providing sufficient capacity and queuing space, and of distributing automobiles to and from parking spaces, pick-up/drop-off points, and drive-through lanes. An integrated system should deliver vehicles from the external roadway system in a manner that is easily understood by drivers, maximizes efficiency, accommodates anticipated traffic patterns, and ensures public safety. Pedestrian linkages should conveniently and safely connect transit stops and parking facilities with building entrances. Similar linkages should be provided between buildings.

It must be understood that simply providing access to a site by means of curb cuts does not necessarily mean that access to the development has been adequately addressed. The quality of access as it relates to the internal site circulation and design will have a direct relationship on the quality of traffic flow in and around the site development, as well as a direct impact on public safety.

ON-SITE PLANNING PRINCIPLES

5-1.902

A. Access Points

Requirements for access to the public street system are detailed in Section 2-1.700 and Section 5-3.200. The guidelines should be followed as closely as possible. Exceptions will only be granted when there are demonstrable extenuating circumstances.

Joint access (the sharing of a driveway by two or more properties) is desirable; particularly where property frontages are short and driveway volumes will be low. Such driveways should be located on joint property lines or be accessible via cross-access easements on the private property being served by the joint driveway.

B. Vehicular Queuing Storage

Adequate internal and external vehicle queuing storage is essential to providing safe and efficient access and circulation. Queuing analyses must be included to demonstrate the adequacy of the proposed storage lanes.

Drive-in and drive-through establishments should be provided with adequate queue storage capacity to accommodate normal peak queues. Since many of these businesses have major daily or seasonal variations in activity, peaking characteristics should be carefully evaluated.

C. Internal Vehicular Circulation

Internal circulation is how vehicular traffic is delivered between entry points and parking areas, pick-up/drop-off points, and service areas. Internal circulation roadways should permit access between all areas. These roads should be designed for appropriate and efficient vehicle movement.

D. Service and Delivery Vehicles

Service and delivery vehicles require separate criteria for movement to and from the site. Of interest is that adequate turning paths are provided for large service vehicles to allow entry and exit without encroaching upon opposing lanes or curbed areas. In addition, sufficient storage areas must be provided so that service vehicles do not hinder the use of parking and circulation routes for other visitors to the site.

E. Pedestrian, Transit, Bicycles, and Accessible Facilities

The overall site plans should also consider public transportation, pedestrians, bicyclists and those with disabilities. Adequate facilities for parking bicycles should be included. Transit facilities, car pool parking, and shuttle bus staging areas should be provided as appropriate for the development. Where provided, these facilities should be located adjacent to service drive and entrance locations, at key locations along circulation drives, or at major pedestrian focal points along the external roadway system.

Pedestrian connections between these facilities and the site's buildings must be integrated into the overall project design and provide maximum accessibility using sidewalk ramps, etc. These connections must also be provided to the public sidewalk and path or trail systems surrounding the site. Refer to Section 5-6.000 Transit, Section 5-7.000 Bikeways, Section 5-8.000 Public Pedestrian Facilities, and Section 5-9.000 Neighborhood Traffic Management.

TIMA REPORT

5-1.1000

PURPOSE AND END USES

5-1.1001

The purpose of the impact and mitigation analysis is to identify and measure the effects of a proposed development on the surrounding transportation system and determine appropriate measures necessary to mitigate those impacts. The developer will be able to utilize the report to evaluate their development proposal and site plan. The city will also utilize the report in reviewing the attributes of proposed developments in conjunction with requests for annexation, land subdivision, zoning changes, building permits, or other development reviews.

PRESENTATION

5-1.1002

The study report will include at a minimum contain the following:

- A. Study purpose and objectives;

- B. A description of the site and study area;
- C. Existing conditions around the development;
- D. Anticipated nearby development;
- E. Trip generation, including comparison to the existing land use or previously approved development;
- F. Trip distribution;
- G. Modal split;
- H. Traffic assignment resulting from the development;
- I. Projected future traffic volumes;
- J. An assessment of the change in roadway operating conditions resulting from the development traffic; and
- K. Recommendations for site access and transportation improvements needed to maintain traffic flow to, from, within, and past the site at an acceptable and safe level of service.

If the assumptions made in the analysis are based on published sources, then those sources should be specifically referenced. If other, less readily available sources are used, a more detailed explanation must be provided, and a copy of the relevant information provided in an appendix.

Please follow the sample report outline provided below and the instructions provided by the Transportation Department staff and/or the Project Coordination Manager when completing the analysis and report. Incomplete reports will be returned to the consultant for revisions or completion prior to a full review of the analysis.

CERTIFICATION

5-1.1003

A professional engineer registered in the State of Arizona must seal the report. If this certification is not provided, the report must be clearly stamped "DRAFT" or "PRELIMINARY."

SAMPLE REPORT OUTLINE

5-1.1004

The outline structure shown in Figure 5-1.2 provides a framework for the Transportation Impact and Mitigation Analysis report. Some studies will be easily documented using this outline; however, additional sections may be warranted because of specific issues to be addressed and/or the results of the study. Likewise, inapplicable sections listed in the outline may be omitted from the report.

TIMA REPORT OUTLINE

I. Introduction to Summary

- A. Purpose of Report and Study Objectives
- B. Executive Summary
 - 1. Site locations and study area
 - 2. Development description
 - 3. Principal findings
 - 4. Conclusions
 - 5. Recommendations

III. Area Conditions

II. Proposed Development

- A. Off-site development
- B. Description of on-site development
 - 1. Lane use and intensity
 - 2. Location
 - 3. Site plan
 - 4. Zoning
 - 5. Phasing and timing

IV. Projected Traffic

- A. Study Area
 - 1. Area of influence
 - 2. Area of significant traffic impact
 - B. Study Area Land Use
 - 1. Existing land uses
 - 2. Existing zoning
 - 3. Trip generation for existing land use
 - 4. Anticipated future development
 - C. Site Accessibility
 - 1. Area roadway system
 - a. Existing
 - b. Future
 - 2. Traffic volumes and conditions
 - 3. Transit service
 - 4. Existing relevant transportation system management
- V. Traffic Analysis**
- A. Site Access
 - B. Capacity and Level of Service
 - C. Safety Performance
 - D. Traffic Signals
 - E. Site Circulation and Parking
- VII. Findings**
- A. Site accessibility
 - B. Traffic impacts
 - C. Need for improvements
 - D. Compliance with applicable city codes
- A. Site traffic (each horizon year)
 - 1. Trip generation
 - 2. Trip distribution
 - 3. Modal split
 - 4 Trip assignments
 - B. Through Traffic (each horizon year)
 - 1. Method of projections
 - a. Method of projections
 - b. Trip generation
 - c. Trip distribution
 - d. Modal split
 - e. Trip assignment
 - 2. Through traffic
 - 3. Estimated volumes
 - C. Total Traffic (each horizon year)
- VI. Improvement Analysis**
- A. Improvements to accommodate base traffic
 - B. Additional improvements to accommodate site traffic
 - C. Alternative improvements
 - D. Status of improvements already funded, programmed, or planned
 - E. Evaluation
- VIII. Recommendations**
- A. Site access/circulation plan
 - B. Roadway improvements
 - 1. On-site
 - 2. Off-site
 - 3. Phasing
 - C. Transportation System Management Actions
 - 1. On-site
 - 2. On-site operational
 - 3. Off-site
 - D. Other Conclusions

FIGURE 5-1.3 TIMA REPORT OUTLINE

MASTER TRANSPORTATION SYSTEM PLAN

For many multi-phased and complex developments, a Master Transportation System Plan (MTSP) is required. This requirement may be established by zoning case

5-1.1100

stipulations or by the Zoning Ordinance. This plan is used to establish the location, size, timing and nature of transportation improvements through the course of development on the site.

These plans are to be submitted prior to or concurrent with development plans on the site and establish the framework for all future development plans submitted on the site. For certain key transportation improvements that serve the entire site, this plan shall serve as the design concept approval from which construction plans can be submitted. Any substantial modifications will require amendment through the same process used to approve the original master plan.

- A. The required components of a MTSP shall be determined by the Transportation staff and may include any of the following components:
 1. Circulation Plan
 - a. Roadway plans showing existing and proposed regional and local roadway network along with existing daily and peak hour traffic volumes.
 - b. Trip generation, distribution and assignment of proposed project trips to the roadway system.
 - c. Access considerations including driveway locations, proposed median break locations, vehicle storage lengths, and any required auxiliary lanes to accommodate site generated trips. Appropriate signing and striping for safe egress and ingress movements shall be included for major intersections.
 - d. Traffic signal warrant analysis at any locations where level of service drops below LOS D conditions and where a traffic signal is proposed.
 - e. Conceptual intersection land configurations based on total PM and AM peak hour volumes with the proposed development.
 - f. Proposed street cross sections and Scottsdale Transportation Master Plan and the applicable standards contained within the Design Standards & Policies Manual (DSPM).
 - g. Associated right-of-way dedications for any streets that do not conform to city standards.
 - h. Determination of the need for any off-site roadway improvements necessary to serve the trip generation resulting from the proposed development.
 - i. Review and analysis of consistency with the City of Scottsdale Transportation Master Plan.
 2. Parking Plan
 - a. This plan shall conform to the provisions contained in Article IX of the Zoning Ordinance.
 - b. The location and number of all parking spaces contained in parking areas and structures.
 - c. Any proposed parking restrictions or validation programs as well as any trip reduction programs.
 - d. The location and capacity of all entrances and exits from parking areas and structures.

3. Bicycle Circulation Plan
 - a. On-street bikeways location, type and dimensions.
 - b. Off-street bikeways location, type, lighting, signage and dimensions.
 - c. Bikeways connections to existing off-site bikeways.
 - d. Bicycle support amenities including but not limited to parking (location, number, type), lockers, showering facilities, security provisions, management provisions, and signage
4. Pedestrian Circulation Plan
 - a. On-site pedestrian walkway locations, dimensions and materials including access to all parking areas and structures, all building entrances and connections to nearby neighborhoods.
 - b. Street-side walkway locations, dimensions and connections to on-site pedestrian walkways.
 - c. Pedestrian amenities including but not limited to lighting, shade, seating, directional signage, over and underpasses, and ADA accessibility.
5. Trails Plan
 - a. Trails locations, materials, and dimensions.
 - b. Trails amenities including but not limited to special signal call buttons, safety fencing, signage and underpasses.
 - c. Trail connections to existing local trails and nearby trail destinations.
6. Transit Plan
 - a. Location of existing or proposed transit routes adjacent to or near the site.
 - b. Adjacent transit-stop locations, size, materials and design.
 - c. Park-and-ride facility locations, access and capacity.
 - d. Pedestrian access connections from on-site uses to transit-stop facilities.
7. Transportation Improvements Phasing Plan
 - a. Identification of phase units/segments within the development site.
 - b. Identification of transportation components proposed to be completed with each phase or segments of the development of the site.
 - c. Interim provisions for transportation components that will be needed to serve completed phases of the plan or for off-site needs that will be replaced by ultimate final improvements.
 - d. Timing/sequencing of any proposed off-site transportation improvements.

Section 5-2

RIGHT-OF-WAY MANAGEMENT

5-2

This section specifies the requirements for securing a permit for encroaching in the city's public right-of-way (ROW) and public utility easements (PUE). It outlines responsibilities and requirements for permits, utility construction plats, construction considerations and as-builts.

GENERAL INFORMATION

5-2.000

The city administers all rights-of-way (ROW) planning, permitting and construction processes in accordance with the following documents:

- A. Maricopa Association of Governments (MAG) Uniform Standard Specifications
- B. City of Scottsdale Supplement to the MAG Uniform Standard Specifications
- C. Arizona Utility Coordinating Committee (AUCC) Public Improvement Project Guide including the Joint Trench Use Model and Western Underground Trench Formula
- D. City of Phoenix Barricade Manual and the Manual on Uniform Traffic Control Devices (MUTCD)

PERMIT REQUIREMENT

5-2.100

Scottsdale requires permits for using the city's ROW under Chapter 47 of the Scottsdale Revised Code (SRC). These permits were previously called encroachment permits.

WORK WITHOUT A PERMIT

5-2.101

Work in the ROW initiated without the appropriate permits is illegal and subject to enforcement action and other ramifications.

PURPOSE OF A PERMIT

5-2.102

Permits are required for all work done in the ROW to:

- A. Regulate the location, alignment and spacing of all work;
- B. Make optimal use of the space available in the ROW;
- C. Require specific materials and design standards;
- D. Require compliance with city ordinances and policies;
- E. Coordinate with other ROW users and city projects;
- F. Protect existing and proposed infrastructure;
- G. Avoid unnecessary traffic delays or congestion;
- H. Keep public uses of the ROW viable;
- I. Monitor safe and expeditious installation;
- J. Address liability, indemnification and assurances;
- K. Restore the ROW and landscaping to their condition before the work was done, as applicable; and
- L. Supervise completion, acceptance and warranty.

TYPES OF PERMITS

5-2.103

There are basically two kinds of permits to use the city's ROW:

A. **Permission to work in the ROW (PWR).**

This permission allows a person to:

1. Work in the ROW to install or maintain improvements;
2. Use the ROW to erect barricades for work in the ROW or next to the ROW;
3. Use the ROW for borings and potholing;
4. Use the ROW for special events;
5. Place dumpsters in the ROW;

6. Maintain landscaping;
7. Test fire hydrants; and
8. Use the ROW for other, generally temporary, uses.

There are different kinds of PWRs. For example, a Special Events Permit serves as one kind of PWR. A PWR that is issued annually, for regular activities in the ROW, such as entering cabinets or landscape maintenance, is an Annual PWR.

B. Permission to place private improvements in the ROW.

This permission allows a person to leave specified private facilities in the ROW:

1. Private facility examples:
 - a. Street furniture,
 - b. Covered walkways,
 - c. Outdoor dining areas,
 - d. Landscaping and irrigation,
 - e. Lighting,
 - f. Water facilities,
 - g. Communications equipment, and
 - h. Other, generally permanent, facilities.

2. Types of PIRs.

There are different kinds of PIRs. For example, a PIR for telecommunications facilities in the ROW is a license, issued under the city's code. A specialized permit for an antenna in the ROW is an Antenna Right-of-Way License Agreement (ARLA).

3. Unique Minor Private Improvements without PIRs.

Some unique minor private improvements such as 2-inch irrigation lines and landscaping may be placed in the ROW without a PIR, upon approval of the Right-of-Way Manager, if the following conditions exist:

- a. The proposed private improvements match the existing public improvements in construction and materials, without an obvious or visible intrusion on the ROW.
- b. The proposed private improvements are used similarly to the existing public improvements, and in no way interfere with the public's use of the ROW, including restricting sight distance.
- c. The proposed private improvements represent a minimal encroachment on the ROW, and a minimal risk to the city.
- d. The proposed private improvements are subject to other permit procedures.

If the Right-of-Way Manager approves a unique minor private improvement without a PIR, the city may require the removal of the private improvement upon at least 30 days' notice. If the owner fails to remove the private improvement within the time specified in the notice, the city may remove the private improvement at the expense of the owner.

EMERGENCIES

When a person does not apply for a barricade plan and PWR before responding to an emergency, the next business day after the emergency, the person shall:

- A. Submit the barricade plan to the city's Inspection Services.

5-2.104

B. Apply for a PWR.

These requirements may be waived by the city's Inspection Services because the emergency has been addressed and all work is completed.

ADDITIONAL REQUIREMENTS

5-2.105

In addition to the PWRs and PIRs, there are additional requirements for certain uses of the city's ROW, such as the following:

A. Telecommunications Facilities

All persons who desire to construct, install, operate or maintain telecommunications facilities in the ROW must first obtain a Telecommunications License from the city, except where state law forbids local license requirements. Licensing information is available by calling the city's Telecommunications Policy Coordinator at 480-312-2953.

B. Cable TV

All persons who desire to construct, install, operate or maintain cable television facilities in the ROW or provide cable television services, programs or signals must first obtain a Cable TV License from the city. Licensing information is available by calling the city's Telecommunications Policy Coordinator at 480-312-2953.

C. Wireless Communications

All persons who desire to construct, install, operate or maintain wireless communications facilities in the ROW must file a pre-application before obtaining any permits. Pre-application information is available by calling the city's Telecommunications Policy Coordinator at 480-312-2953.

D. Utilities

Unless state law provides otherwise, persons who desire to construct, install, operate or maintain facilities in the ROW, to provide electric service, gas, water and other utilities to the public are required to obtain the appropriate franchise, license or other permit from the city. Franchises and licenses may contain all the legal requirements of and are PIRs. However, persons operating under franchises and licenses must submit plans, and obtain PWRs, for work in the ROW.

E. Soil Nail Shoring

Soil nails protruding into public and/or private rights-of-way and easements are subject to permitting and city code requirements.

F. Overweight and Oversize Vehicles and Loads

Overweight and oversize vehicles and loads operating in the ROW are subject to the requirements of the Arizona Revised Statutes and city code.

G. Transportation-for-hire

Transportation-for-hire in the ROW is subject to the requirements of the Arizona Revised Statutes and city code.

H. Hauling

Persons hauling sand, dirt, gravel and construction debris in the ROW are subject to the permit and other city code requirements.

I. Valet Parking

Valet parking operations using the ROW are subject to the licensing and other city code requirements.

J. Special Events

Special events are subject to permit and other city code requirements.

PERMIT PROCEDURES

5-2.106

A. Fees for Permits

Fees for PWRs are set forth in the city's Fee Schedule published on the city's website.

B. Timeframes for Permits

PWRs and PIRs are exempt from Senate Bill (SB) 1598.

C. Permit Conditions

See the Barricade Plan requirements in Section 5-2.300

See the city code, Chapter 47, requirements.

D. Additional permits.

The permit holder shall obtain any additional permits required to use the right-of-way, including a building permit, barricade plan, native plant permit, State and County permits, and others.

E. Standards.

All work shall be performed safely, in a workmanlike manner, and pursued diligently to completion. All work shall conform to city improvement standards.

F. Applicable laws.

All use of or work in the right-of-way shall be conducted and performed in conformance with all applicable federal, state, county and city laws, ordinances, rules and regulations.

G. Conformance to permit and plans.

The permit holder shall comply with the permit conditions, its attachments and applicable approved plans.

H. Change of conditions affecting work in the right-of-way.

The ROW Manager, or designee, in an emergency or other circumstance significantly interfering with the public uses of the right-of-way, may change the provisions of a permit to work in the right-of-way to promote, preserve and protect public health, safety and welfare.

I. Removal of property upon request.

After termination or revocation of a permit, upon the city's request, the permit holder shall immediately remove all personal property from the right-of-way.

PERMIT DURATION

5-2.107

A. A PWR and a PIR may include an expiration date.

B. A PWR must be sought promptly after improvement plan approval (within 6 months of approval) and work under a PWR must begin promptly and be diligently pursued to completion.

C. An inspection must be obtained within 6 months after a PWR is issued, or the PWR expires. Each successive inspection must occur within 6 months of the previous inspection or the PWR expires. If a PWR expires, the improvement plans Approval also expires.

PERMIT SUSPENSION, REVOCATION AND ENFORCEMENT

5-2.108

- A. See the SRC, Chapter 47, for the city's enforcement authority.
- B. The city may take enforcement action to protect the public interest in the right-of-way, including:
 - 1. Issuing a stop-work order, and
 - 2. Suspending or revoking a permit.
- C. The city may take enforcement action under several conditions, including the following:
 - 1. If the permit holder's insurance lapses or expires.
 - 2. If any false statement or misrepresentation was made in the application or improvement plans on which the permit was based.
 - 3. If an emergency or other circumstance significantly interferes with the public uses of the right-of-way.

INSURANCE FOR PERMITS

5-2.200

PERMIT HOLDER LIABILITY AND INDEMNIFICATION

5-2.201

- A. The permit holder shall be responsible for all liability and damages arising from or related to any acts or omissions of the permit holder or its agents, contractors, subcontractors and anyone else connected with the permit.
- B. To the fullest extent of the law, the permit holder shall defend, indemnify and hold harmless the city, its officers, officials, representatives, agents, employees and volunteers from and against all allegations, demands, proceedings, suits, actions, claims, damages, losses, expenses, including but not limited to, attorney fees, court costs, the cost of appellate proceedings, and all claim adjusting and handling expenses, arising from or related to any acts or omissions of the permit holder or its agents, contractors and subcontractors under the permit.

GENERAL INSURANCE REQUIREMENTS

5-2.202

- A. No permit shall be issued, nor work commenced, until the city receives proof of insurance to its satisfaction.
- B. The insurance required may be set forth in the proposed PWR or PIR. If no insurance requirements are provided in the applicable Permission, the requirements below apply.
- C. Unless otherwise approved by the city, the permit holder and subcontractors must procure and maintain insurance required below, until all their obligations have been discharged. Where the permit involves a permanent obstruction, the required insurance must remain in effect until the obstruction is removed. If any required insurance expires during the life of the permit, the permit holder must forward to the city renewal certificates within ten (10) days after the renewal date containing all the required insurance.
- D. The applicant shall furnish the city a certificate of insurance on a standard insurance industry ACORD form (or equivalent, as approved by the city), with original endorsements effecting required coverage. The certificate must be issued by an insurance company duly licensed or approved unlicensed to do business in

Arizona, with an A.M. Best rating of at least B++6. The certificate and endorsements for each policy must be signed by a person authorized to bind the insurer.

- E. Risk Management may set higher or lower limits of liability insurance depending on risk exposures.

GENERAL COVERAGE REQUIREMENTS

5-2.203

A. **Commercial General Liability Coverages.**

All required policies are to contain, or be endorsed to contain, the following:

1. The city, its officers, officials, representatives, agents, employees and volunteers must be additional insureds with respect to liability arising out of or related to activities performed by, or on behalf of, the permit holder (including the city's general supervision of the permit holder, if any); product and completed operations of the permit holder; and automobiles owned, leased, hired, or borrowed by the permit holder. The city, its officers, officials, representatives, agents, employees and volunteers must be additional insureds to the full limits of liability even if those limits of liability are more than those required by the permit.
2. The insurance must be Commercial General Liability - Occurrence Form, with limits of at least \$1,000,000 for each occurrence, \$1,000,000 products and completed operations annual aggregate, and \$1,000,000 operations, independent contractors, products, completed operations, personal injury and advertising injury. If any excess insurance is used to fulfill the requirements of this section, the excess insurance must be "follow form" equal or broader in coverage than the underlying insurance.
3. The insurance must provide broad form contractual liability coverage, including coverage for liability arising out of explosion, collapse, or underground property damage hazards ("XCU").
4. The insurance must be primary insurance with respect to the city, its officers, officials, representatives, agents, employees and volunteers. Any insurance or self-insurance maintained by the city, its officers, officials, representatives, agents, employees and volunteers must be more than the coverage provided by the permit holder and must not contribute to it.
5. The insurance must apply separately to each insured against whom claim is made or suit is brought, except with respect to the limits of the insurer's liability.
6. The insurance must contain a waiver of subrogation against the city, its officers, officials, representatives, agents, employees and volunteers, for losses arising from activities performed by, or on behalf of, the permit holder.
7. The insurance must not expire, or be suspended, voided, cancelled or materially altered without at least 30 days advance written notice, sent by certified mail, return receipt, to the One Stop Shop at 7447 East Indian School Road, Suite 225, Scottsdale, AZ 85251.

B. **Workers Compensation Insurance.**

Workers Compensation Insurance must be provided as required by law.

C. Self-insured Retentions and Deductibles.

Any self-insured retentions and deductibles must be declared and are subject to city approval. If not approved, the city may require that the insurer reduce or eliminate any self-insured retentions with respect to the city, its officers, officials, representatives, agents, employees, and volunteers.

D. Subcontractor's Insurance.

If any work under the permit is subcontracted in any way, the permit holder must execute a written agreement with the subcontractor containing the same indemnification requirements and insurance requirements as stated in this manual to protect the city. The permit holder will be responsible for executing the agreement with the subcontractor and obtaining certificates of insurance verifying the insurance requirements.

E. Claims Made.

The insurance may not be a "claims made" policy.

MODIFICATIONS TO INSURANCE

5-2.204

- A. Any modification to these insurance requirements is subject to approval by Risk Management. The decision on modifications is final.
- B. Any modification shall be in writing as approved by the Risk Management and may be made by administrative action.

CITY RIGHTS, DISCLAIMERS AND RELIANCE

5-2.205

- A. The city may review all the required insurance policies and endorsements but has no obligation to do so. Failure to demand any evidence of full compliance with the insurance requirements stated in this section or failure to identify any insurance deficiency does not relieve the permit holder from, nor be construed or considered a waiver of, its obligation to maintain the required insurance during the life of the permit.
- B. The city in no way warrants that:
 - 1. The minimum insurance company rating is sufficient to protect the permit holder from insurer insolvency, or
 - 2. Any other insurance requirement is sufficient to protect the permit holder from liabilities that might arise.
- C. The insurance requirements are minimum requirements for permits that require insurance and in no way limit the indemnity provisions of the permit.
- D. Failure by the applicant to provide the city with the required insurance certificate and failure by the city to demand a certificate before such a permit is issued, does not waive the permit holder's obligation to provide the insurance.
- E. If a certificate of insurance is submitted as verification of coverage, the city will reasonably rely upon the certificate of insurance as evidence of coverage, but this acceptance and reliance will not waive or alter in any way the permit holder's insurance requirements or indemnity obligations.

TRAFFIC CONTROL PLANS

5-2.300

The purpose of a Traffic Control Plan (TCP) is to proactively plan for, coordinate and minimize the impacts of encroachment and construction in the ROW. The Traffic Control Plan is designed to help the city understand what traffic impacts will occur during a construction project. The Traffic Control Plan is intended to identify the phasing of large projects, including lane restrictions, closures, plating or any restriction that could delay the traveling public.

- A. A Traffic Control Plan needs to be submitted prior to (with plans) or accompanied by the permit application for all proposed work in or on Primary Roads, see Figure 5-2.2. The Traffic Control Plan is subject to all city review processes and must be reviewed and subject to approval by the city prior to permit issuance. Additional information and stipulations may be required on a case-by-case basis. The required Traffic Control Plan is in addition to the submission of a Barricade Plan prior to the start of construction, see Section 5-2.608.
- B. The Traffic Control Plan shall:
 1. Provide the estimated start date, preferably within 15 days of actual construction.
 2. Provide the duration of construction.
 3. Provide hours that traffic restrictions will be in place (24-hour, off-peak mid-day and off-peak night, etc.).
 4. Identify the length of the project and location details, including lane closures and type of work.
 5. Describe any construction phasing that will occur during the project, specifically how the barricading configuration will change during the duration of the project and how it will be accomplished in the project schedule.
 6. Provide a map of the affected area of construction, showing existing lane striping, proposed work zone, existing speed limit and detail all driveway, alleys, transit facilities, median breaks or other locations where traffic may enter/exit or conflict with the project work zone.
 7. Barricade plans and construction traffic control in general shall comply with the Barricade Management Ordinance. Failure to comply may result in a Notice of Violation (NOV) or civil citations being issued to the barricade company, developer or contractor. Refer to SRC 47-105 for list of violations and fine amounts.

UTILITY CONSTRUCTION PLAN

5-2.400

All Utility and Telecommunications Construction Plans must comply with Section 1-2 and Section 9-1. Additional plan details may be required on a case-by-case basis.

WORK HOURS IN THE ROW

5-2.500

Generally, no interference with traffic flow on Primary Roads (Figure 5-2.1) is permitted during the hours of 7 to 9 a.m. or from 4 to 6 p.m. unless prior authorization is obtained in writing by the Traffic Engineering Director or designee. Specific work

hours may be stipulated by the city on the project's Barricade Plan. Night work must have prior authorization from the city and may be required by the Right of Way Manger or designee. In addition, certain areas of the city may have seasonal or special event restrictions for construction work, as designated by the city on a case-by-case basis. Contact the Traffic Engineering Division at 480-312-7696 for updated seasonal or special event restrictions.

ROW LICENSES AND LEASES

5-2.600

WORK CLASSIFICATIONS

5-2.601

All License holders and Lessee's improvements and other construction, repair, maintenance and other work (collectively "Work") shall be divided into three categories: Heavy Work, Medium Work and Light Work.

A. **Heavy Work**

Heavy Work is any work that involves any of the following:

1. Complete blockage of a sidewalk or trail.
2. Any work or construction signage closer to the center of a street than the edge of pavement or back of curb.
3. Any work that involves workers or equipment within thirty (30) feet of an intersection measured from the closest edge of pavement or back of curb.
4. Any work that does or is projected to take more than seven (7) days to complete.
5. Any work that involves excavating more than five (5) cubic yards of dirt, digging more than three hundred (300) feet of trench, or any boring.
6. Any work that involves any traffic breaks, diversions or interruptions, any temporary or permanent alteration of traffic signals or signs or traffic control devices, or any rerouting of traffic.

B. **Medium Work**

Medium Work is all work that is not Heavy Work but involves workers or equipment being used or located within ten (10) feet of any portion of any public street right of way designated for vehicle travel, within one hundred (100) feet of the nearest part of any intersection measured from the closest edge of pavement or back of curb, or upon or interfering in any way with any sidewalk, path or trail.

C. **Light Work**

Light Work is all work that is not medium work or Heavy Work.

STREET CLASSIFICATIONS

5-2.602

For the purposes of Licenses and Leases, All Right of Way shall be divided into three categories; Critical Streets, Large Streets, and Small Streets, as follows:

A. **Critical Streets**

Critical Streets are all the Scottsdale Road, Hayden Road, Pima Road and Shea Boulevard Right of Way and all Right of Way within one hundred (100) feet of the Rights of Way of any of these roads. During January and February, Critical Streets also include Frank Lloyd Wright Boulevard, Bell Road, Princess Drive and Perimeter

Center Drive. Critical Streets are only the roads named in this paragraph and do not include other streets, such as those encircled by the Critical Streets.

B. Large Streets

Large Streets are all streets shown on Scottsdale's General Plan and on the Primary Roads Map (Figure 5-2.1) as Major Arterials, Minor Arterials, or Collectors.

C. Small Streets

Small Streets are all street and road Right of Way that is not Critical Streets or Large Streets.

RESTRICTIONS

5-2.603

A. Light Work Restrictions

All Light Work shall comply with the following:

1. Lessee shall obtain all permits.
2. Lessee shall not perform Light Work to Critical Streets during the hours of 6am to 9am or 4pm to 7pm Monday through Friday (collectively "Rush Hours").

B. Medium Work Restrictions

All Medium Work shall comply with all the restrictions applicable to Light Work and with the following:

1. Lessee shall give the city ten (10) days notice of any medium work.
2. Lessee shall not perform Medium Work to Critical Streets or Large Streets during Rush Hours.

C. Heavy Work Restrictions

All Heavy Work shall comply with all the restrictions applicable to Medium Work and Light Work and the following:

1. Heavy Work is prohibited on Critical Streets during the period from November 15 to April 30.
2. Lessee shall give the city ten (10) days notice of any Heavy Work.
3. Licensee's giving notice under this paragraph is not a substitute for obtaining Licensor's approval of the proposed work.

D. Work Restriction Waivers

The Right of Way Manager shall have the authority but not an obligation to grant written exceptions to the provisions of Chapter 5 Section 2 that limit the days or times during which the Licensee may conduct Work.

JOINT TRENCHING POLICY

5-2.604

Work in the ROW has significantly increased over the past several years causing disruption to the traveling public, continual pavement cuts often in the same location and conflicting with other facilities within the ROW. For these reasons, the city has increased its management of work in the ROW, enacting a joint trench process for projects being done on Primary Roads. This policy is designed to:

1. Minimize the public's inconvenience with minimal lane closures;
2. Decrease multiple pavement cuts that detract from the life of the street;
3. Allow for proper space allocation within a limited ROW area;
4. Aesthetically address multiple users' needs with properly placed facilities, manholes and cabinets, etc.

A. Criteria

The city requires a permittee to joint trench a project if the project is located on a Primary Road and the trench is 1,000 feet or longer. Joint trenching may also be required by the city on a case-by-case basis when a permittee's trench is 1,000 feet or less or on a Secondary Road. The requirement for joint trenching on a Primary or Secondary Road is defined to include the entire ROW, not just curb-to-curb. All requests for an exception to the joint trench requirement for any project must be submitted in writing to the city and will be reviewed and approved by city staff on a case-by-case basis.

B. Procedure

1. Preliminary planning and design should be done by the permittee in accordance with the AUCC's Joint Trench Use Model.
2. The permittee must contact potential joint trench participants, as listed on file with the COS. Call the City of Scottsdale (COS) Telecommunications Policy Coordinator 480-312-4138 to obtain a current participant list.
3. The permittee as the lead provider, must send a notice to each potential participant, either by fax, email or U.S. mail, of the joint trench opportunity, and provide proof of notice to the city.
4. The permittee must also post a joint trench opportunity notice on the city's web site utilizing the AUCC Joint Trench Notification Form.
5. If participation is requested by another provider, then the permittee must give a minimum 2 weeks' timeframe for interested companies to supply the permittee with their needs, so they can be included in the permittee's working drawing.
6. As part of the project plan set, the permittee must provide a trench cross-section and a plan that depicts the details of the proposed work, including the trench, manholes, driveways, utility cabinets/facilities locations and other appurtenances. The plan must show that all location conflicts have been resolved.
7. The permittee then submits 3 copies of the plan set, along with a permit application and a Traffic Control Plan to the city's One Stop Shop for staff review and approval.
8. Upon city approval of the plan, the permittee obtains the permits and schedules an on-site pre-construction meeting with the city's utility inspector to review the proposed work, timing of work and any approved barricade plans prior to commencing any work.

C. Participants

Participants in the joint trenching include public utility and telecommunication providers (both current and future licensees).

D. Failure to Participate

Permits involving asphalt cuts and joint trench locations will only be issued once during a 2-4-year timeframe in any given location. Providers need to plan accordingly. Under extreme circumstances, the city may, at its sole discretion, waive the stated timeframe requirements. A franchise agreement or license is

required to use the ROW. Companies not possessing a license must do so by contacting the city's Telecommunications Policy Coordinator at 480-312-4138.

VACUUM EXCAVATION AND POTHOLING

5-2.605

A permit is required for all utility location work. All potholing will be done in accordance with City of Scottsdale (COS) Standard Details to the MAG Uniform Standard Specifications, Details 2200 and 2201, located on the city's web site.

STREET BORING REQUIREMENTS

5-2.606

All utilities or other facilities crossing existing city streets, regardless of the age of the street, must be bored or punched unless permission to open cut has been given in writing by the city Traffic Engineering Director or designee. The burden of proof will lie with the permittee to show that boring is not a feasible requirement. The permittee must specify the boring method on the construction plans, such as "directional boring." This requirement is used to assess appropriate boring methods. Certain types of boring, such as use of water jets are not allowed. The permittee must also indicate on the construction plans the anticipated impact on and restoration of existing facilities. The proposed method is approved by the city on a case-by-case basis during plan review. If field conditions are such that boring has been demonstrated to city Inspections to be infeasible, then the permittee may be permitted to open cut.

UNDERGROUNDING REQUIREMENT

5-2.607

All new public utility, cable TV, telecommunications fiber optic, cellular, dark fiber or similar facility must be installed underground. If new facilities are proposed in an area that has existing overhead lines, the new facilities will be required to go underground and any permittees with existing overhead facilities may participate in reinstalling these facilities underground when a joint trench opportunity is provided. When major upgrades are planned, utility and telecommunications providers may underground existing facilities currently on existing poles.

Installation of new facilities or major enhancements to existing facilities need to be installed underground unless it can be demonstrated that the public's general health, safety and welfare are affected by the underground installation or that the provider lacks the ability to install the facilities underground. The fact that an underground installation is costlier than an overhead installation is not, in and of itself, a health or safety issue.

All above ground appurtenances need to be designed and installed with attention to minimizing the number of appurtenances, maximizing joint locations, combining with existing boxes and sharing facilities. All locations will meet industry standards for sight distance locations, all industry safety requirements and the aesthetic requirements of the city. The issuance of a permit in violation of any of the requirements will not void the permittee's responsibility, unless the substandard installation is clearly noticed and approved separately from the normal permit requirement.

BARRICADE PLAN

5-2.608

A. Work in/on residential streets typically does not need a Barricade Plan, but, unless otherwise exempted by law, all signs, barricades and other necessary traffic control

devices need to be placed in accordance with the [city of Phoenix Barricade Manual](#), and the [MUTCD](#).

- B. Where a Barricade Plan is required, it must be submitted through the city's online digital plan submittal portal a minimum of 3 work days before any proposed partial or complete closure of a street, alley, sidewalk, bus stop, trail, or other public way.
- C. Work cannot be initiated on the portion of the project requiring barricading until Barricade Plan approval has been obtained in writing from both Inspection Services and Traffic Engineering divisions.
- D. The Barricade Plan must be prepared by a person certified by the American Traffic Safety Services Association (ATSSA).
- E. The Barricade Plan must include the following information:
 - 1. Streets names, alleys and major driveway intersections to be barricaded.
 - 2. Sidewalks, trails and multi-use paths to be barricaded.
 - 3. Bus bays and any bus stop infrastructure to be barricaded.
 - 4. Sign and barricade types to be used by code or graphic depiction.
 - 5. Sign and barricade location and spacing, including Variable Message Board (VMB), relocated traffic control signs, and project identification signs.
 - 6. Taper and tangent length.
 - 7. Graphic depiction of vehicle travel lanes and bike lanes.
 - 8. Detour plans.
 - 9. North arrow.
 - 10. The hours of operation for the project.
 - 11. The construction duration and schedule.
 - 12. Barricade plan preparer, barricade company and contractor contact information.
- F. Except during emergencies, pedestrian service/safety needs to be fully preserved at crosswalks (marked/ unmarked) and other facilities used by pedestrians. The Barricade Plan must incorporate these six fundamental principles for successfully accommodating pedestrians through work zones:
 - 1. Traffic and pedestrian safety must be an integral and high-priority element in every project, from planning through design and construction.
 - 2. Pedestrian and traffic movements should be inhibited as little as practical and planned to reduce exposure to potential hazards.
 - 3. Pedestrians and motorists should be guided in a clear and positive manner while approaching, traversing and leaving work sites.
 - 4. Routine inspection of traffic control devices must be performed. Personnel must be adequately trained in the proper management of pedestrian and traffic control, so they are qualified to make work zone safety decisions in the selection, placement and maintenance of traffic control devices.
 - 5. Pedestrian paths through the work zones should replicate as nearly as possible the elements of the existing path and comply with the Americans with Disabilities Act (ADA).
- G. The Barricade Plan must be in substantial conformance with the Phoenix Traffic Barricade Manual.

- H. Traffic control devices shown in the Barricade Plan must be installed and/or removed by persons certified by Phoenix through successful completion of its temporary traffic control training program. An employee working for a company certified by Phoenix is deemed certified. Scottsdale accepts the Phoenix temporary traffic control training program certification as set forth in the Phoenix 2007 Traffic Barricade Manual, as amended.
- I. Traffic control devices may be placed only when work is about to begin is underway, or another justifiable reason exists to protect the public health, safety or welfare.
- J. A copy of the approved Barricade Plan must be available at the jobsite at all times when work is occurring, including placing and removing barricades. The barricade company is responsible for having the Barricade Plan on site when its workers are placing or removing the traffic control devices.
- K. Where a major change to a Barricade Plan is required, it must be submitted on a Barricade Plan change form to Inspection Services a minimum of 3 work days prior to any proposed change, by faxing the Barricade Plan to 480-312-5704.

CONSTRUCTION SIGNS

5-2.609

The permittee is required to post information signs (see Figure 5-2.2) at the work site identifying the name of the utility authorizing the work. The purpose of the sign is to identify the permittee authorizing the work and the contractor performing the work. This signage is still required even when marked company vehicles are present at the work site. Required sign information also includes a phone number where a person can call and receive information about the job and leave a message. The permittee must respond to all phone messages within 24 hours. In addition, all permittees must return regular traffic control signs back to their original place and replace any signs damaged during construction. General signage requirements are listed below. Specific project signage may be required by the city on a case-by-case basis.

A. Primary Roads

Projects on Primary Roads, as identified in Figure 5-2.1 that are either greater than 1 mile in length or have a construction timeframe of 30 calendar days or longer, must utilize the following signage, and as shown in Figure 5-2.2:

1. VMB sign at each end of the project indicating:
 - a. Location of construction, including cross streets names.
 - b. Direction of travel restricted.
 - c. Dates and duration.
 - d. Alternate route suggested.
2. Stationary Signs at each end of the project indicating:
 - a. Names of authorizing company and permittee.
 - b. Phone number for job information and as means to get a response to phone calls/message.
 - c. Estimated start and completion dates for project.
 - d. Project description.
 - e. Conform to the following format:
 - i. At least 4-foot x 4-foot size sign, with a minimum of 4 inch to 6-inch letters (black legends/orange background).

- ii. Type style is to be block, sans serif, medium width stroke, no more than 50 per- cent condensed, and not extra bold, not italics letters for better readability (For example: Helvetica medium typestyle).
 - iii. Sign should have an inset border with rounded corners.
- B. Other Primary and All Secondary Roads**
- All projects not meeting the criteria listed above in Section 5-2.609 paragraph A. must post two stationary signs that conform to Section 5-2.609 paragraph A.2. above, or as directed by Traffic Engineering.

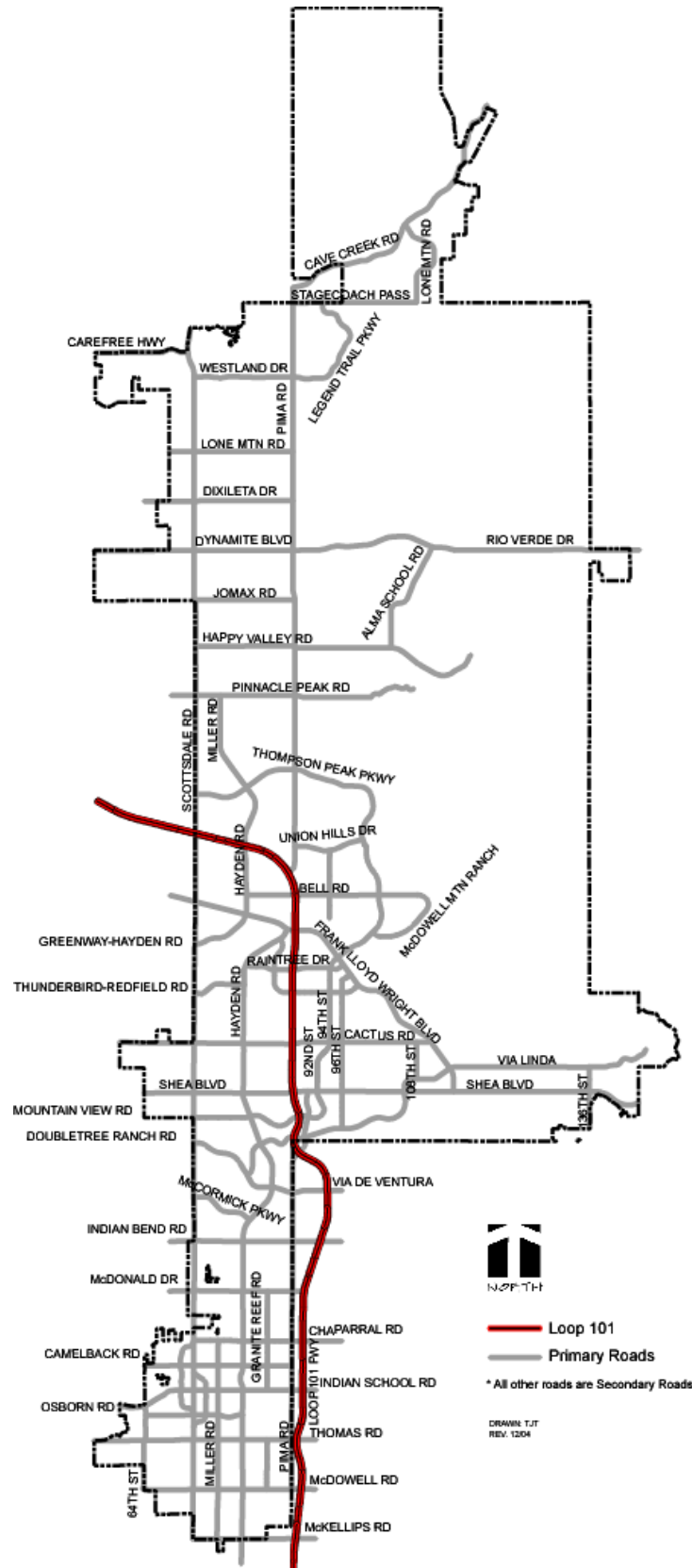

FIGURE 5-2.2 PRIMARY ROADS

COMMUNITY NOTIFICATION

5-2.610

In addition to the above signage requirements, community notification will be required where there will be significant traffic, ingress/egress, construction or noise impacts on an area. Community notification may take different forms depending upon the permitted project or work. Some possible methods of notification could include: additional signage, door hangers, community newsletters, press releases and should try to include one method of auditory/electronic delivery such as community meetings, phone message lines and web site information. The city reserves the sole right to determine the appropriate community notification requirements for all permitted projects on a case-by-case basis.

INSPECTIONS

5-2.611

All above ground and underground facilities and equipment placed in the ROW, and all construction work done in the ROW is subject to periodic and final inspection for compliance, with all permit requirements, as well as all applicable city, state and federal laws. Permittee must notify Inspection Services at 480-391-5750 at least 72 hours prior to beginning permitted construction work in the ROW. Requests for city inspections must be made 24 hours in advance of required inspections.

PAVEMENT CUTS

5-2.612

As outlined in Chapter 47 of the SRC when excavations are made in any paved, resurfaced or sealed roadway, the roadway shall be reconstructed to the standards set forth in the MAG Standards. Standards are greater for newly constructed or reconstructed structural sections less than four (4) years old or pavement with a rubberized surface course. Temporary pavement sections are not allowed.

- A. Any person who damages right-of-way or public improvements in the right-of-way shall reimburse the city the expense of repairing the damage.
- B. The city is not responsible for damages to private improvements in the right of way.

STRIPING AND MARKING REQUIREMENTS

5-2.613

All striping and markings requirements, placement and removal must comply with:

- A. The [MAG](#) Uniform Standard Specifications and
- B. The [MUTCD](#).

TRANSIT FACILITIES AND AMENITIES

5-2.614

If the project affects a bus stop, the permittee must create a temporary bus stop, with comparable amenities, if feasible, as close to the affected stop as possible and in a safe location. An accessible route of travel must also be provided. Permittee must also return all transit facilities and amenities to their original location and condition or replace them if damaged during construction. Permittees must, as part of their traffic control plan, address how buses (which are generally 108 inches wide, plus mirrors) will maneuver through the site and whether a detour is necessary. In addition, the permittee needs to provide a minimum 2-week notice to the city's transit office so that the city can provide information about detours, access and projected construction

timeframe. If the construction is an emergency, the city's Transit Office needs to be notified immediately 480-312-7696.

ABANDONED FACILITIES AND FACILITIES REMAINING AFTER EXPIRATION OF PIR

5-2.615

- A. If at any time a permittee wishes to cease using and abandon facilities within the ROW, or if the permittee has not applied for and received an extension or renewal of the original permit from the city before an encroachment permit has expired, the permittee must provide for the disposition of its facilities within the ROW as outlined below.
- B. If a permittee desires to abandon its facilities within the ROW, they must submit an abandonment request to Inspection Services Utility Permit Coordinator. The abandonment request may designate one of three alternatives (as defined below). The city then approves the request by issuing an abandonment plan. In issuing an abandonment plan, the city considers and attempts to accommodate the permittee's preference; however, the city retains the sole choice to designate one of the following three options:
 1. Require the permittee to remove all structures, cable, equipment or facilities; or
 2. Permit the city to accept ownership, in which case, the title to such structures, cable, equipment or other facilities vests in the city; or
 3. Require the permittee to leave the facilities in place. If the facilities are abandoned in place, the permittee must record the facilities as "Abandoned in Place" and permanently maintain such records. Facilities that are "Abandoned in Place" will not need to be removed by the permittee. However, the permittee, by abandoning facilities in place, expressly permits the removal of such facilities by any future party at the sole discretion of the city.
- C. If the abandonment plan requires the removal of facilities from the ROW, and the permittee fails to remove its structures, cable, equipment or other facilities within 180 days of notification by the city, then the city will serve written notice of failure to comply. Furthermore, if the permittee fails to rectify the removal within 10 days from the date the notice was received, the city may rectify the default as outlined below:
 1. Upon removal of the structures, cable or other facilities, the city may submit in writing the cost incurred. Upon the permittee's receipt of notice of such amount, it shall immediately become a lien against the permittee's company and shall remain a lien in favor of the city until the amount is paid in full, together with interest at the annual rate of 10 percent.
 2. In the event no abandonment request is submitted to the city, the city has complete discretion to determine the disposition of all structures, cable, equipment or other facilities left within the ROW. Any costs and expenses incurred immediately becomes a lien against the permittee's company and will remain a lien in favor of the city until the amount is paid in full by the permittee, together with interest at the annual rate of ten (10) percent.
 3. The right and remedy will not be exclusive, and the city has all the rights and remedies available to it in accordance with the laws of the State of Arizona and

the City of Scottsdale. The establishment of a lien does not preclude the city from establishing additional liens upon subsequent failure or failures to remove any improvement.

- D. Abandonment of all above ground facilities and appurtenances are also subject to all the requirements stated above.

ALLEYS

5-2.616

If construction or work is planned in an alley, prior to commencing work, the permittee needs to contact Sanitation at 480-312-5600 to obtain the days of sanitation pickup for that alley. Those days are to be listed on the plan along with a plan note that construction is prohibited on those days; exceptions may be made on a case-by-case basis by the Sanitation Director or designee. A Barricade Plan must be submitted to Inspection Services (where submitted, to whom/what location) at least 72 hours prior to commencing work for any work to be done in an alley.

AS-BUILTS

5-2.700

The city requires submittal of as-built plans for all facilities constructed or installed within public ROW or within easements that are owned by the city. The permittee, who constructs facilities (not owned by the city) in the public ROW or within the easement, is required to maintain the facility as-builts and provide them to the city. The preferred as-built format is digital in either Micro Station or ArcView SHP format. The digital as-builts must conform to the Maricopa Association of Governments Computer Aided Drafting (CAD) standards and must reference the city ROW permit number, see Section 1-3.00. It is preferred that digital as-builts utilize the city's base maps (streets, ROW and parcels) as the foundation for the drawings.

Section 5-3

GEOMETRICS

5-3

This section identifies the geometric requirements for each street classification within the city. It includes guidance for sight distance, access, sidewalks, roundabouts, bridges, retaining walls and structural clearances, side slopes, partial street improvements, pavement transitions, frontage roads, subdivision streets and geographic part of COS planned for the ESL zoning district (ESL area) street standards.

GENERAL INFORMATION

5-3.000

NATIONAL STANDARDS

5-3.001

Unless otherwise stated, the design of street infrastructure in the city shall conform to the standards contained in the national publications generally accepted by the Civil Engineering profession, such as the most recent editions of the American Association of State Highway and Transportation Officials' (AASHTO) A Policy on Geometric Design of Highways and Streets, and the AASHTO's Roadside Design Guide.

All traffic control devices must comply with the MUTCD prepared by the FHWA, Arizona Supplement prepared by ADOT, as well as Section 5-4. and Section 5-5. of this manual. For access control guidelines refer to the Transportation Research Board's (TRB) Access Management Manual.

Other references include the publications by the FHWA, the TRB, the United States Department of Transportation (USDOT), NCHRP, the ITE, and the American Society of Civil Engineers (ASCE).

Important reference documents include the AASHTO Guide for the Planning, Design and Operation of Pedestrian Facilities; the Guidelines and Recommendations to Accommodate Older Drivers and Pedestrians published by the FHWA; and the Highway Decision Handbook for Older Drivers and Pedestrians also by the FHWA.

STREET TYPES

5-3.002

City street types are as follows:

A. **Freeways**

Freeways will be designed to safely handle very large volumes of through traffic. Direct access will be limited to widely spaced interchanges. Design, construction and operations will be provided by the Arizona Department of Transportation (ADOT).

B. **Arterial Streets**

Arterial streets with raised medians provide regional continuity and carry large volumes of traffic between areas of the city and through the city. Full access to abutting commercial and multi-family land uses is limited to the greatest extent possible to facilitate movement of traffic. Pedestrian and bicycle crossings should be grade separated when feasible.

C. **Collector Streets**

Collector streets provide traffic movement between arterial and local streets, with some direct access to abutting commercial and multi-family land uses. Center left-turn lanes are provided to allow for greater access. Driveway access should be evenly spaced.

D. **Local Streets**

Local streets provide direct access to abutting land uses, provide access to the collector street system, and accommodate low traffic volumes. Local streets should be designed to eliminate long, straight sections to discourage high travel speeds. Deciding the location of local collector, residential, commercial and industrial streets is usually done during the development site planning process. Planning for

local streets is influenced by the existing street system in the surrounding area and the plans for adjacent developments that have recently been approved. The Transportation and Planning staff will review each preliminary proposal for development and will specify any changes needed to conform to previously planned and approved street alignments. Transportation and Planning staff will also specify the classification for each street involved in the plan.

STREET CLASSIFICATIONS

5-3.003

The City of Scottsdale Street Classification includes the following:

A. Major Arterials

1. Rural Character
2. Suburban Character
3. Urban Character

B. Minor Arterials

1. Rural/ESL Character
2. Suburban Character
3. Urban Character

C. Couplets

D. Major Collectors

1. Rural/ESL Character
2. Suburban Character
3. Urban Character

E. Minor Collectors

1. Rural/ESL Character with Trails
2. Rural/ESL Character
3. Suburban Character
4. Urban Character

F. Local Collectors

1. Rural/ESL Character with Trails
2. Rural/ESL Character
3. Suburban Character

G. Local Residential

1. Rural/ESL Character with Trails (lot size greater than 20,000 sq. ft)
2. Rural/ESL Character (lot size greater than 20,000 sq. ft)
3. Suburban Character (lot size under 20,000 sq. ft)
4. Urban Character (lot size under 20,000 sq. ft)

H. Local Commercial/Industrial

I. Low Volume Streets

The six street classifications are based upon the type and level of use for which streets are intended; refer to the specified Figures in Section 5-3.100 for design standards. Special cross sections and design criteria apply to streets located within the Hillside or Upper Desert/Lower Desert areas of the ESL area; Figure 2-2.1 depicts the locations in the city where these criteria apply.

J. Complete Streets

In 2008 City Council approved a ‘complete streets’ policy for inclusion into the policy element of the 2008 Transportation Master Plan. The 2016 Transportation Master Plan likewise includes a City Council adopted ‘complete streets’ policy as follows, “All new and improved Scottsdale streets shall provide sufficient right-of-way (ROW) and shall be designed with ‘complete streets’ concepts to safely accommodate motorists, bicyclists, pedestrians, equestrians, and transit riders of all ages and abilities.”

The ‘complete streets’ policy ensures that the entire ROW is designed and operated to enable safe access for all users. Components of a ‘complete street’ may include: sidewalks, paths, bike lanes, crosswalks, wide shoulders, medians, bus pullouts, special bus lanes, raised crosswalks, audible pedestrian signals, sidewalk bulb-outs, and more.

The ‘complete streets’ policy promotes a multimodal transportation approach for all city new and retrofit roadway projects. This approach aims to create a comprehensive, integrated and connected network.

DESIGN STANDARDS

5-3.100

Appendix 5-3A lists most of the design standards data necessary for the design of streets within the city. Subsequent paragraphs in this chapter discuss these standards and provide other criteria that could not be included in the table. Average Daily Trips (ADT) values stated below are guidelines for planning street classifications. In addition, minor adjustments to the standard cross sections may be considered by the Transportation Department on a case-by case basis. Scenic Corridors are shown on the below cross sections for illustrative purposes and the Scenic Corridors should be verified with the Scenic Corridors Design Guidelines.

MAJOR ARTERIALS

5-3.101

A. Rural Character

1. Auxiliary turn lanes may be required at intersections with additional right-of-way (ROW) requirements
2. Cross-sections may vary to fit surrounding topography
3. ADT: 35,000 - 55,000 vpd
4. Design Speed: 55 mph
5. Maximum Grade: 6.0 percent
6. Minimum Grade: 0.4 percent

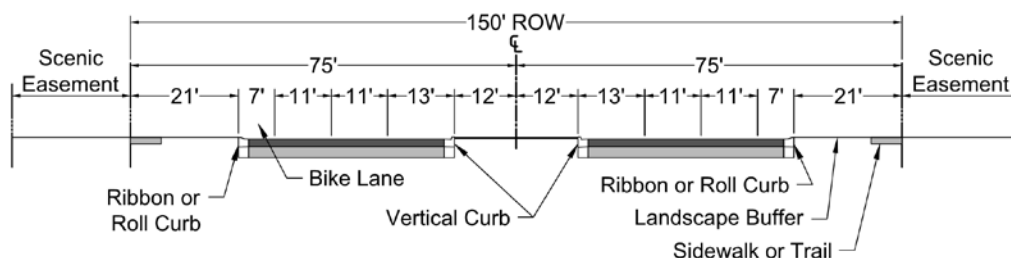

FIGURE 5-3.1 MAJOR ARTERIALS -- RURAL CHARACTER

B. Suburban Character

1. Auxiliary turn lanes may be required at intersections with additional ROW requirements
2. Cross-sections may vary to fit surrounding topography
3. ADT: 35,000 - 55,000 vpd
4. Design Speed: 55 mph
5. Maximum Grade: 6.0 percent
6. Minimum Grade: 0.4 percent

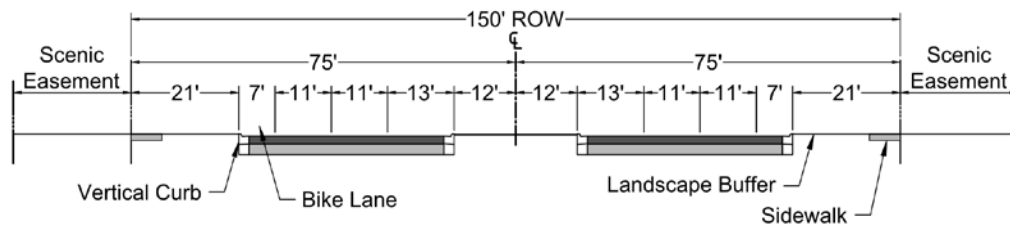

FIGURE 5-3.2 MAJOR ARTERIALS -- SUBURBAN CHARACTER

C. Urban Character

1. Auxiliary turn lanes may be required at intersections with additional ROW requirements
2. Cross-sections may vary to fit surrounding topography
3. ADT: 35,000 - 55,000 vpd
4. Design Speed: 45 - 55 mph
5. Maximum Grade: 6.0 percent
6. Minimum Grade: 0.4 percent

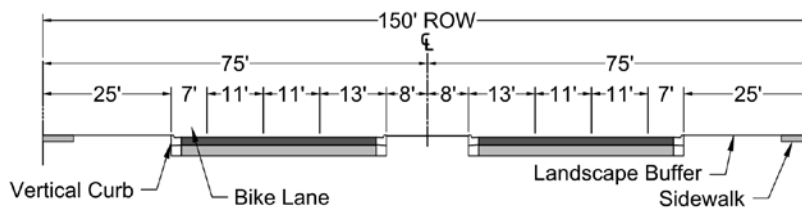

FIGURE 5-3.3 MAJOR ARTERIALS – URBAN CHARACTER

MINOR ARTERIALS

A. Rural/ESL Character

1. Auxiliary turn lanes may be required at intersections with additional ROW requirements
2. Cross-sections may vary to fit surrounding topography
3. ADT: 25,000 - 35,000 vpd
4. Design Speed: 45 mph
5. Maximum Grade: 6.0 percent
6. Minimum Grade: 0.4 percent

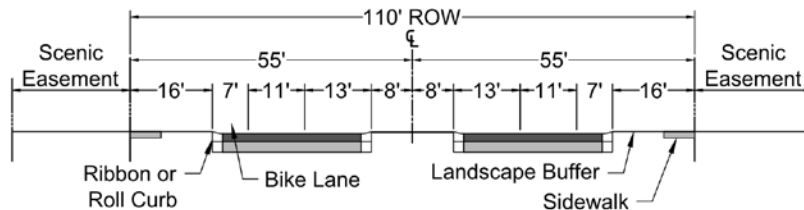

FIGURE 5-3.4 MINOR ARTERIALS -- RURAL/ESL CHARACTER

B. Suburban Character

1. Auxiliary turn lanes may be required at intersections with additional ROW requirements
2. Cross-sections may vary to fit surrounding topography
3. ADT: 25,000 - 35,000 vpd
4. Design Speed: 45 mph
5. Maximum Grade: 6.0 percent
6. Minimum Grade: 0.4 percent

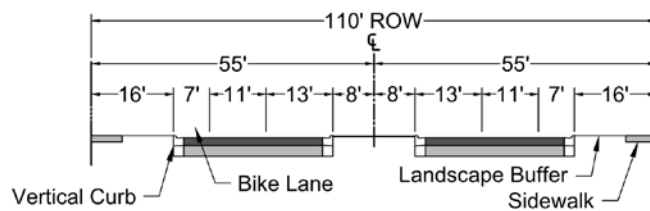

FIGURE 5-3.5 MINOR ARTERIALS -- SUBURBAN CHARACTER

C. Urban Character

1. Auxiliary turn lanes may be required at intersections with additional ROW requirements
2. Cross-sections may vary to fit surrounding topography
3. ADT: 25,000 - 35,000 vpd
4. Design Speed: 45 mph
5. Maximum Grade: 6.0 percent
6. Minimum Grade: 0.4 percent

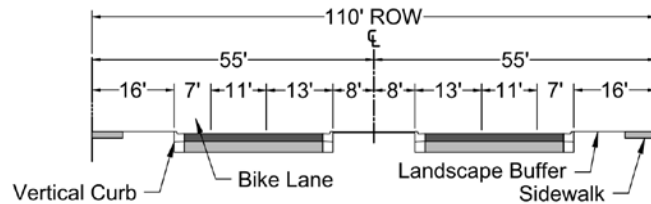

FIGURE 5-3.6 MINOR ARTERIALS -- URBAN CHARACTER

COUPLETS

Couplet to be constructed in accordance with the Downtown Urban Design and Architectural Guidelines and:

- A. Auxiliary turn lanes may be required at intersections with additional ROW requirements
- B. Cross-sections may vary to fit surrounding topography
- C. ADT: 25,000 - 35,000 vpd
- D. Design Speed: 35 - 45 mph
- E. Maximum Grade: 6.0 percent
- F. Minimum Grade: 0.4 percent

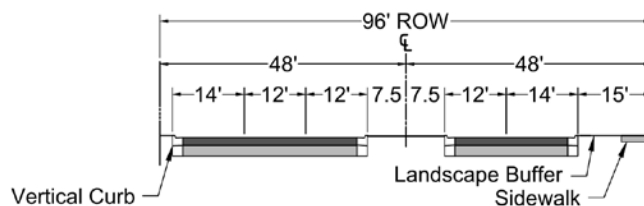

FIGURE 5-3.7 COUPLET STREETS

5-3.103

MAJOR COLLECTORS

5-3.104

A. Rural/ESL Character

1. Auxiliary turn lanes may be required at intersections with additional ROW requirements
2. Cross-sections may vary to fit surrounding topography
3. ADT: 15,000 - 30,000 vpd
4. Design Speed: 35 - 45 mph
5. Maximum Grade: 9.0 percent
6. Minimum Grade: 0.4 percent

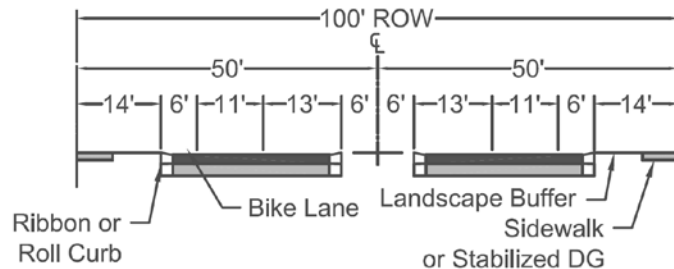

FIGURE 5-3.8 MAJOR COLLECTORS -- RURAL/ESL CHARACTER

B. Suburban Character

1. Auxiliary turn lanes may be required at intersections with additional ROW requirements
2. Cross-sections may vary to fit surrounding topography
3. ADT: 15,000 - 30,000 vpd
4. Design Speed: 35 -45 mph
5. Maximum Grade: 9.0 percent
6. Minimum Grade: 0.4 percent

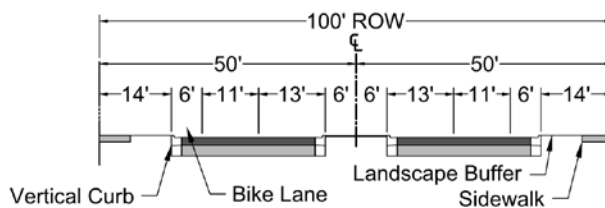

FIGURE 5-3.9 MAJOR COLLECTORS -- SUBURBAN CHARACTER

C. Urban Character

1. Auxiliary turn lanes may be required at intersections with additional ROW requirements
2. Cross-sections may vary to fit surrounding topography
3. ADT: 15,000 - 30,000 vpd
4. Design Speed: 35 - 45 mph
5. Maximum Grade: 5.0 percent
6. Minimum Grade: 0.4 percent

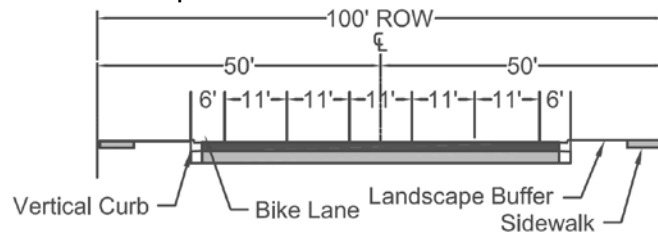

FIGURE 5-3.10 MAJOR COLLECTORS -- URBAN CHARACTER

MINOR COLLECTORS

5-3.105

A. Rural/ESL Character with Trails

1. Auxiliary turn lanes may be required at intersections with additional ROW requirements
2. Cross-sections may vary to fit surrounding topography
3. ADT: 5,000 - 15,000 vpd
4. Design Speed: 30 - 35 mph
5. Maximum Grade: 12.0 percent
6. Minimum Grade: 0.4 percent

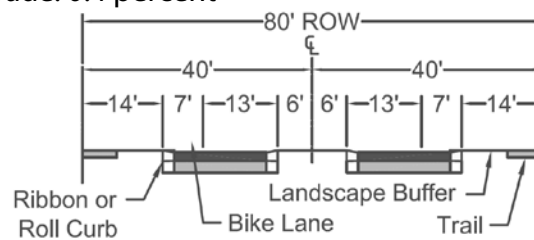

FIGURE 5-3.11 MINOR COLLECTORS -- RURAL/ESL WITH TRAILS

B. Rural/ESL Character

1. Auxiliary turn lanes may be required at intersections with additional ROW requirements
2. Cross-sections may vary to fit surrounding topography
3. ADT: 5,000 - 15,000 vpd
4. Design Speed: 30 - 35 mph
5. Maximum Grade: 12.0 percent
6. Minimum Grade: 0.4 percent

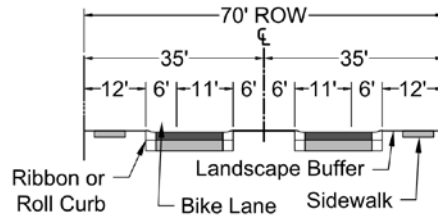

FIGURE 5-3.12 MINOR COLLECTORS -- RURAL/ESL CHARACTER

C. Suburban Character

1. Auxiliary turn lanes may be required at intersections with additional ROW requirements
2. Cross-sections may vary to fit surrounding topography
3. ADT: 5,000 - 15,000 vpd
4. Design Speed: 30 - 35 mph
5. Maximum Grade: 9.0 percent
6. Minimum Grade: 0.4 percent

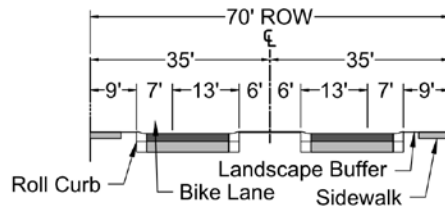

FIGURE 5-3.13 MINOR COLLECTORS -- SUBURBAN CHARACTER

D. Urban Character

1. Auxiliary turn lanes may be required at intersections with additional ROW requirements
2. ADT: 5,000 - 15,000 vpd
3. Design Speed: 35 mph
4. Maximum Grade: 9.0 percent
5. Minimum Grade: 0.4 percent

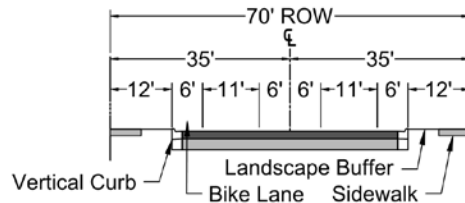

FIGURE 5-3.14 MINOR COLLECTORS -- URBAN CHARACTER

LOCAL COLLECTORS

5-3.106

A. Rural/ESL Character with Trails

1. Auxiliary turn lanes may be required at intersections with additional ROW requirements
2. Cross-sections may vary to fit surrounding topography
3. ADT: 1,500 - 5,000 vpd
4. Design Speed: 30 mph
5. Maximum Grade: 12.0 percent
6. Minimum Grade: 0.4 percent
7. A six-foot-wide sidewalk may be required on one side of the street

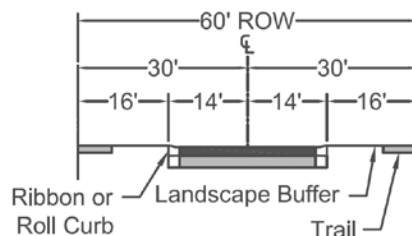

FIGURE 5-3.15 LOCAL COLLECTORS -- RURAL/ESL WITH TRAILS

B. Rural/ESL Character

1. Auxiliary turn lanes may be required at intersections with additional ROW requirements
2. Cross-sections may vary to fit surrounding topography
3. ADT: 1,500 - 5,000 vpd
4. Design Speed: 25 - 30 mph
5. Maximum Grade: 12.0 percent
6. Minimum Grade: 0.4 percent
7. A six-foot-wide sidewalk may be required on one or both sides of the street based upon the character of the area

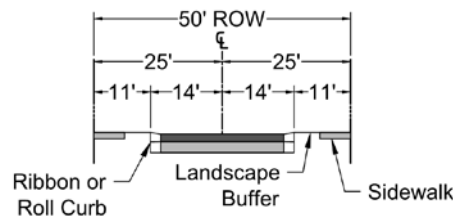

FIGURE 5-3.16 LOCAL COLLECTORS -- RURAL/ESL CHARACTER

C. Suburban Character

1. Auxiliary turn lanes may be required at intersections with additional ROW requirements
2. Cross-sections may vary to fit surrounding topography
3. ADT: 1,500 - 5,000 vpd
4. Design Speed: 25 - 30 mph
5. Maximum Grade: 9.0 percent
6. Minimum Grade: 0.4 percent

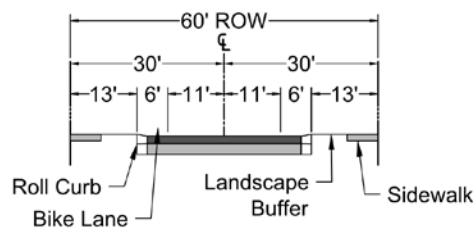

FIGURE 5-3.17 LOCAL COLLECTORS -- SUBURBAN CHARACTER

LOCAL RESIDENTIAL

A. Rural/ESL Character with Trails (lot size greater than 20,000 square feet and/or subdivision of 10 or fewer lots)

1. Auxiliary turn lanes may be required at intersections with additional ROW requirements
2. Cross-sections may vary to fit surrounding topography
3. ADT: 1,500 vpd maximum
4. Design Speed: 25 miles per hour (mph) for geometrics; 30 mph for sight distance
5. Maximum Grade: 19.0 percent
6. Minimum Grade: 0.4 percent
7. Sidewalk may be required on one side or both sides of the street based upon lot size and/or number of subdivision lots and the character of the area

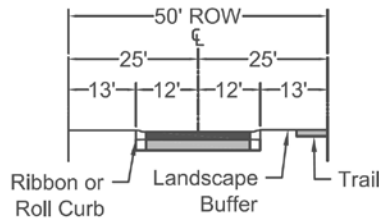

FIGURE 5-3.18 LOCAL RESIDENTIAL -- RURAL/ESL WITH TRAILS

B. Rural/ESL Character (lot size greater than 20,000 square feet and/or subdivision of 10 or fewer lots)

1. This cross section is intended to apply adjacent to lots with 20,000 square feet in area or greater and in areas with rural character (may apply in areas without ESL zoning district designation)
2. Cross-sections may vary to fit surrounding topography
3. ADT: 1,500 vpd maximum
4. Design Speed: 25 mph; 30 mph for sight distance
5. Maximum Grade: 19.0 percent
6. Minimum Grade: 0.4 percent
7. Sidewalk may be required on one side or both sides of the street instead of a shoulder based upon lot size and/or number of subdivision lots and area character
8. Sidewalk attached or detached

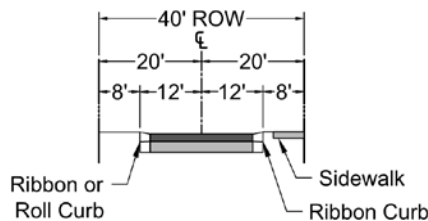

FIGURE 5-3.19 LOCAL RESIDENTIAL -- RURAL/ESL CHARACTER

C. Suburban Character (lot size under 20,000 square feet)

1. This cross section is intended to apply adjacent to lots with less than 20,000 square feet in area and in areas with suburban character (may apply in ESL designated areas)
2. ADT: 1,500 vpd maximum
3. Design Speed: 25 mph; 30 mph for sight distance
4. Maximum Grade: 9.0 percent
5. Minimum Grade: 0.4 percent
6. Sidewalk attached or detached

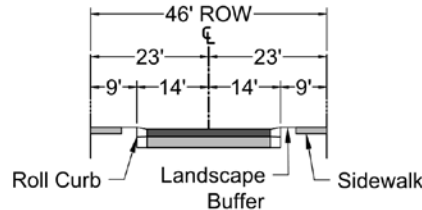

FIGURE 5-3.20 LOCAL RESIDENTIAL -- SUBURBAN CHARACTER

LOCAL COMMERCIAL AND INDUSTRIAL

5-3.108

1. Auxiliary turn lanes may be required at intersections with additional ROW requirements
2. ADT: 1,500 - 5,000 vpd
3. Design Speed: 25 mph; 30 mph for sight distance
4. Maximum Grade: 15.0 percent
5. Minimum Grade: 0.4 percent
6. Sidewalk attached or detached

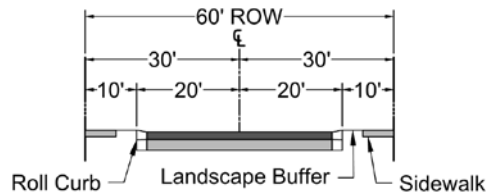

FIGURE 5-3.21 LOCAL COMMERCIAL/INDUSTRIAL

LOW VOLUME STREETS

5-3.109

A. Alternate Standards

The city may apply the following standards to low volume streets.

B. Criteria

All the following criteria must be met before low volume street standards would be considered:

1. The street must only serve residential uses
2. The street must only serve metes and bounds properties or a minor subdivision
3. The street must only serve 35,000 square feet or larger lots
4. The street must be classified as Local Residential

5. The street must be in existing right-of-way, or the applicant must be willing to dedicate adequate right-of-way
6. The ADT must be planned and forecasted to be lower than 400

C. Standards for all Low Volume Streets

Where low volume street standards are allowed, the project design must:

1. Comply with any adopted Local Area Infrastructure Plan, as amended
2. Be fully engineered, including drainage analysis:
3. Dip crossings must address the Bureau of Reclamation graph depicting the depth-velocity flood danger level for passenger vehicles
4. In washes, downstream erosion control/cut off walls must comply with the city's additions to the MAG standards
5. Comply with the Design Specifications for 25 mph design speed. Refer to Appendix 5-3A
6. Address adequate fire/refuse access
7. Show signage as required

D. Low Volume Rural Standard

1. This standard applies, after all criteria are met, for streets with planned and forecasted 150 to 400 ADT
2. There shall be at least 3-inches asphalt on a 6-inches base
3. The asphalt surface shall be at least 22-feet wide, including 2 lanes with a thickened edge in compliance with MAG Standard Detail 201, "Pavement Section at Termination".
4. On both sides of the asphalt surface, there shall be at least 2 feet of compacted material to support emergency vehicles
5. The street should generally follow the natural grade, but is subject to drainage requirements

E. Low Volume Unpaved Standard

1. This standard applies, after all criteria are met, for streets with fewer than 150 ADT planned and forecasted
2. There shall be at least a 6 inches Aggregate Base Course (ABC) base, or, with city approval, millings or city-approved equivalent to millings
3. The surface shall be at least 22 feet wide
4. On both sides of the surface, there shall be at least 2 feet of compacted material to support emergency vehicles
5. The surface must be treated regularly for dust control
6. The street should generally follow the natural grade, but is subject to drainage requirements
7. Where grades are 12 percent and steeper, pavement is required for all-weather access

SIDEWALKS

A. Sidewalk Standards

Sidewalk Location/Conditions	Typical Sidewalk Width
Functioning as a multi-use path	10 feet
Along arterials and major collectors in urban conditions and areas with heavy pedestrian	10 feet minimum
Along arterials and major collector streets	8 feet minimum
Along minor collector and local collector streets	6 feet; 8 feet in activity
Along local residential and local commercial	6 feet; 8 feet in activity
Local streets in ESL/rural conditions	5' sidewalk one side**
* 8-foot-wide sidewalk may be required along minor collector and local collector streets near schools, parks, and other activity centers.	
** A 4-foot-wide ribbon curb may be provided as an alternative to sidewalk or no sidewalk in ESL/rural areas or where constraints prevent the use of standard sidewalk.	

FIGURE 5-3.22 SIDEWALK STANDARDS

Sidewalks adjacent to all city streets are required to meet the standard cross sections contained in Section 5-3.100 and the Streets Master Plan except as noted below.

In cases where a sidewalk width of six feet cannot be provided due to existing physical barriers or other constraints, a clear and continuous sidewalk width of five feet may be allowed if approved by the Planning and Development Director or designee.

Sidewalk widths may be modified on a case-by-case basis with approval by the DRB, except when the width is specified in an associated zoning case.

Sidewalk separation is required along all streets except local streets (local residential, local collector, local commercial/industrial). Sidewalk separation may not be possible in areas with limited right-of-way or where obstructions are present. Sidewalks may be located at the back of curb in an urban area where additional sidewalk width is provided. Refer to Section 5-8. Public Pedestrian Facilities for more detail regarding sidewalk design and requirements.

B. Sidewalk Locations

All new sidewalks constructed adjacent to public and private arterial and collector streets shall be separated from the back of curb unless right-of-way or other constraints make this impossible. The minimum separation from the back of curb should be 4 feet. Wherever possible, the sidewalk should be located adjacent to the right-of-way line (with a one-foot clearance). Sidewalks may be located within adjacent easements, such as scenic corridors or public access, where available. Sidewalks should not be located within 10 feet of the edge of pavement or back of curb for arterials streets without vertical curb.

C. Sidewalk Exemptions

Sidewalks will be provided on all streets except under any of the following conditions:

1. Along local residential and local collector streets in rural, low density areas – lot widths are 150 feet or more, or parcels are 20,000 square feet or more on both

street sides – where improved shoulders are provided along both sides of the street or a 4-foot-wide ribbon curb is provided.

2. Along the side of a street where a multi-use path is required. The multi-use path will also serve as a sidewalk.
3. In the outer separation between an arterial and a frontage road.
4. With the approval of the DRB in an area that has been substantially developed without sidewalks and a required sidewalk would create a spot location.
5. In conformance with a street cross section that has been approved as part of a master circulation plan.
6. Along the side of a local street in the ESL/rural areas where a non-paved trail is provided.
7. Access must be provided that conforms to the ADA from lots to the adjacent street along sections where no sidewalk is provided (one or both sides of the street).

PRIVATE STREETS

5-3.111

All private streets shall be constructed to full public street standards, except equivalent construction materials or wider cross-sections may be approved by the Transportation Department. No internal private streets shall be incorporated into the city's public street system at a future date unless they are constructed, inspected, maintained and approved in conformance with the city's public street standards and approved by the City Council. Before issuance of any certificate of occupancy (C of O) for the site, the developer shall post access points to private streets to identify that vehicles are entering a private street system.

LANE WIDTHS

5-3.112

New street construction shall include standard lane widths as identified in the cross sections contained in the Design Standards Section 5-3.100 above. Where right-of-way, utility, and other constraints make using the standard lane widths economically unfeasible, narrower lane widths may be approved by the Transportation Director or designee. Generally, 11-foot lanes widths are acceptable for through lanes, 10-foot lane widths are acceptable for auxiliary/turn lanes. For low volume, low speed streets 10-foot wide through lanes may be acceptable.

STREET RIGHTS-OF-WAY

5-3.113

Rights-of-way requirements are based on the space needed for the street to meet ultimate development requirements, refer to Section 5-2 and Section 5-3.100. Rights-of-way provides space for utilities, cut or fill slopes, sidewalks, bicycle paths, trails, traffic control devices and information signs, fire hydrants, landscaping, transit facilities and other public facilities that must be located adjacent to street pavements.

Additional rights-of-way may be required at major intersections to provide for turn lanes.

Rights-of-way widths more than the standard widths may be required in special circumstances such as where:

- A. Cut or fill slopes cannot be confined within the standard width;
- B. A roundabout is being considered as a traffic control device;

- C. Auxiliary lanes are to be provided.

PAVEMENT CROSS-SECTION SLOPES

5-3.114

A. **Typical Street Cross-Sections**

Undivided streets should have a normal crown that is a two-way cross-slope with the cross-section high point on the street centerline. Divided streets should have cross-slope on each pavement section. The high point of each slope on each pavement section must occur on the edge of the pavement nearest to the median. Unusual conditions may cause cross-slope requirements to vary, but normally, the desirable cross-slope is 2 percent, with a maximum cross-slope of 3 percent. Any deviation from the desirable cross-slope is subject to approval by the Transportation Department.

B. **Cross-Sections in Street Dip Sections**

While dip sections are discouraged, where storm drainage runoff flows must cross the street, dip sections are needed. The pavements through the dip section should have a one-way slope (no crown), curbing and medians must not be raised, and cut-off walls must be installed in accordance with city standard details. Transitions back to normal street cross-slopes will be needed at both ends of the dip section.

MEDIANS

5-3.115

A. **Median Widths**

Median widths are measured from back-of-median curb to back-of-median curb. Where there is no curb, width is measured from the centers of the continuous, painted median stripes. In special circumstances, the Transportation Department may approve other widths.

B. **Paved Medians**

A median 4 feet wide or less should be paved. The paved surface should be crowned and have the same cross-slope as the street pavement. Typical materials are Portland cement concrete, concrete pavers, stamped concrete, or exposed aggregate concrete.

C. **Unpaved and Landscaped Medians**

Medians that are greater than 4 feet in width are normally not paved. The grading of the unpaved areas should be as shown below in Figure 5-3.23. If a median is to be landscaped, it shall be at least 4 feet wide. Near intersections, landscaping and other median features must not restrict sight distance for left turning vehicles on the through street or for vehicles entering from the side street. Refer to Appendix 5-3B, Section 5-3.121, Section 5-3.123, Figure 5-3.26 and Figure 5-3.27 for specific sight distance criteria.

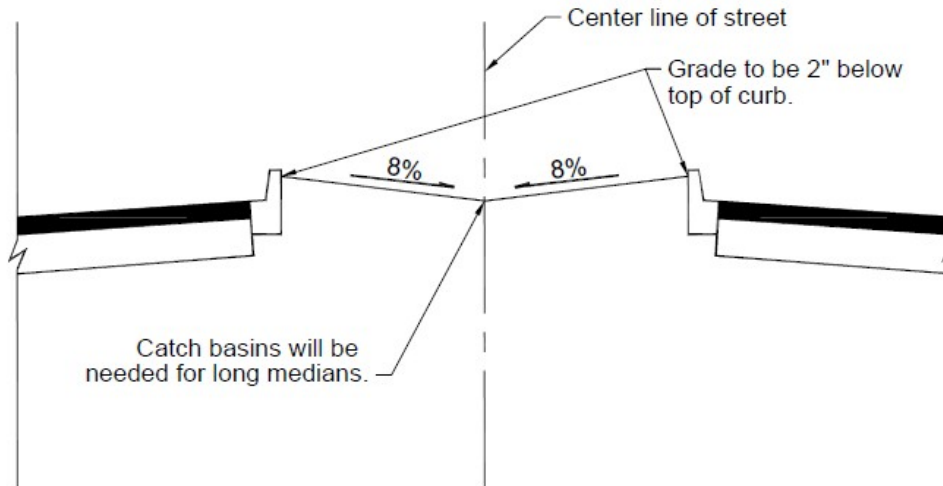

FIGURE 5-3.23 MEDIAN GRADING300

CURBS

5-3.116

A. Vertical Curbs

Vertical curbs are generally required for all streets in urban and suburban areas except local residential streets refer to Appendix 5-3A. Vertical curbs may be used in place of roll curbs on local streets if beneficial for drainage considerations. Vertical curbs may be used on high speed roadways where the posted speed will be 45 mph or less. Vertical curbs provide positive access control, a refuge for pedestrians in the median and protection of signs.

Vertical curbs with gutter are to be constructed in accordance with City of Scottsdale Supplemental Standard Details for Public Works Construction, matching the adjacent pavement slope to the gutter cross slope direction. The curb height shown on the standard detail is 6 inches, but the following variations may be used where appropriate.

1. Where fire lane or public maintenance vehicle access to abutting property must be provided over the curb, use city mountable curb and gutter.
2. If special drainage requirements make a higher curb necessary, the curb may be increased to 8 inches maximum and the gutter may be increased to 24 inches wide.

B. Roll Curb

A roll curb is preferred for local residential and local collector streets to provide direct lot access and for drainage considerations, especially on streets with adjacent sidewalk. Roll curbs may be used on major and minor collector streets where an adequate clear zone is provided based on AASHTO Roadside Design Guidelines. They are to be constructed in accordance with MAG Standard Details. Roll curbs are not an acceptable substitute for curb ramps.

C. Ribbon Curb

Ribbon curb may be used in lieu of roll curb for local residential streets in low-density, large lot areas, typically where lot size is greater than 20,000 square feet. When ribbon curb is used, drainage runoff from the road should not drain along

the road but will be directed to roadside drainage ditches. For design criteria for roadside ditches or swales refer to Chapter 4.

Ribbon curb should also be used on the outside lanes of arterial streets in rural areas (speed limit 45 mph or greater, access point average equals 500 feet or greater) with a shoulder and an adequate clear zone provided.

D. No Curb, Maricopa Edge

Type A Maricopa Edge (MAG Standard Detail 201) may also be used for local residential streets in low-density, large lot areas, typically where lot size is greater than 20,000 square feet with approval from the Transportation Director, or his designee. When Maricopa Edge is used, drainage runoff from the road should not drain along the road but will be directed to roadside drainage ditches. For design criteria for roadside ditches refer to Section 4-1.204, and Figure 4-1.3 for a typical cross section.

Any asphalt concrete street that is constructed without concrete curb shall include a "safety edge" in conformance with the guidelines provided by the FHWA.

E. Median Curb

In locations where raised medians are constructed, vertical curb should generally be utilized. Roll curb may be used around medians on low speed, low volume streets, typically associated with traffic calming projects, or where needed to maintain adequate width for emergency vehicles.

F. Cut-Off Walls

In locations where dip sections are permitted to allow drainage flows to cross roadways, cut-off walls conforming to city standard details must be installed on both the upstream and downstream sides of the roadway. Cut-off walls must be at least 3 feet deep and have a top that is flush with the pavement surface. The exposed portion of the cut-off wall will have the appearance of a ribbon curb, with the same width as the street's regular curb and gutter, refer to Figure 5-3.26. The cut-off walls must extend across the flow path in the dip section to protect the pavement structure during runoff flows from a 100-year storm. Transitions will be needed between the regular curb and the cut-off wall at each end of the dip section.

G. Curb Returns

Vertical curb should be used through the curb return from point of curvature (PC) to point of tangent (PT) regardless of whether the tangent curb sections are vertical or roll curb. All curb returns must be provided with sidewalk from PC to PT of the same width as that provided for the sidewalk behind the tangent curb sections. If no sidewalk is provided behind the tangent curb sections, the curb return sidewalk should be at least 6 feet wide on local streets, 8 feet on collectors and arterials.

1. Curb Return Radii

The radii for curb returns measured to the back of curb will be 25 feet for local street intersections - those that involve either a local collector street or local residential street. The radii for curb returns measured to the back of curb shall be 30 feet for all other major street intersections. Smaller radii may be approved by the Transportation Department in urban areas with higher pedestrian

activity. Radii larger than 30 feet shall not be used for any street without approval from the Transportation Department.

2. Sidewalk Ramp at Curb Return
Sidewalk ramps shall be constructed at all curb returns at all street intersections with other streets or driveways in accordance with MAG Standard Details.
3. Detectable warning devices will be installed on all sidewalk ramps at street intersections per ADA guidelines and [COS Standard Detail](#) No. 2231301
4. . If a traffic signal exists or is planned, the ramp and apron must provide access to the pedestrian push button. These standards apply to both public and private streets; refer to Section 5-4.104 Pedestrian Signals for more information.

SIDE SLOPES

5-3.117

A. Side Slope Standards

Side slopes should be designed for functional effectiveness, ease of maintenance and pleasing appearance. For areas greater than 10 feet back of curb, slopes of 1:4 (rise to run) or flatter will be provided. Steeper slopes may be approved in areas more than 30 feet back-of-curb when soils are not highly susceptible to erosion, or when a cut is not more than 4 feet. Consult the AASHTO publication, Roadside Design Guide for further details. The DRB must review cuts or fills greater than 4 feet. For more information refer to Chapter 2.

B. Slope Rounding

The top of all cut slopes need to be rounded where the material is other than solid rock. A layer of earth overlaying a rock cut also will be rounded. The top and bottoms of all fill slopes for, or adjacent to, a traveled way, sidewalk, or bicycle path also need to be rounded. Refer to Section 2-1 for more information.

DESIGN SPEED

5-3.118

The design of geometric features such as horizontal and vertical curves will depend upon the design speed selected for the street. The choice of the design speed is primarily determined by the street classification. The design speed is the maximum speed for the safe operation of a vehicle. The use of design speeds other than those shown may be approved through the master plan process. The Transportation Department must approve all other exceptions.

SUPERELEVATION IN CURVES

5-3.119

Superelevation is discouraged on horizontal curves in the portion of the city outside the Environmentally Sensitive Lands area.

A. 0.02 foot/foot (ft/ft) Superelevation Rate

A superelevation rate of 0.02 foot/foot may be used when the standard radius cannot be provided due to circumstances beyond the control of the engineer, and the roadway alignment cannot be changed (as determined by city staff).

B. Superelevation Rate Greater than 0.02 ft/ft

A superelevation rate greater than 0.02 ft/ft may not be used except when approved by the Transportation Department. In no case shall a superelevation exceed 0.06 ft/ft

C. Transition for Superelevation

The length of superelevation transition is based on the superelevation rate and the width of rotation. The axis of rotation is generally the pavement centerline. The transition lengths for a superelevation rate of 0.02 ft/ft are provided in Appendix 5-3A. For other superelevation rates, refer to the AASHTO's Policy on Geometric Design.

In designing the beginning or ending of a horizontal curve, 1/3 of the transition is on the curve and 2/3 of the transition is on the tangent pavement section.

D. Drainage on Superelevated Curves

Whenever superelevation is allowed on a divided street, a storm drainage system must be provided to collect the runoff along the median curb. Nuisance water from the higher traveled area is not allowed to cross the lower traveled area.

HORIZONTAL CURVES

5-3.120

Horizontal alignments need to provide safe and continuous operation of motor vehicles at a uniform design speed for substantial lengths of street. At a minimum, a horizontal curve is typically required when the angle of change in horizontal alignment is equal to or greater than two degrees. The nature of the surrounding development and topography, and the street classification will establish the factors that determine the radius of a curve.

A. Minimum Radii of Curvature

The minimum radius of curvature is determined by the design speed or by the stopping sight distance.

1. Minimum Radii Based on Design Speed

Appendix 5-3A contains the minimum radius of curvature depending on design speed with and without a superelevation rate of 0.02 ft/ft. Wherever possible, the radii used in design needs to be larger. If stopping sight distance conditions require a larger radius than that shown in these appendices, then that larger radius becomes the minimum radius for the curve.

2. Consideration of Stopping Sight Distance

When walls, buildings, bridge piers, cut slopes, vegetation, or other obstructions are near the roadway on the inside of a curve, they can block a driver's view of the road ahead. If they are too near, the driver will not have sufficient distance along the curved roadway to stop when a hazardous condition comes into view. For design, the driver's eye is 3.5 feet above the center of the inside lane (the driving lane nearest to the inside of the curve) and a hazardous condition is an object 2.0 feet high in the center of the inside lane, or per currently accepted AASHTO standards. The clear distance, "M" is measured from the center of the inside lane to the view obstruction. Figure 5-3.27 depicts these relationships.

Refer to AASHTO "A Policy on Geometric Design of Highways and Streets" Section 3-3.12 for Stopping Sight Distance calculations.

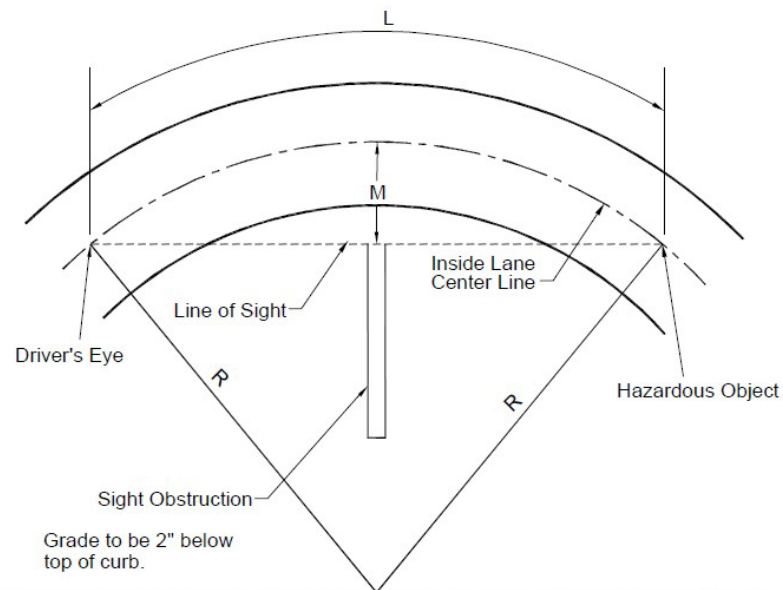

If the stopping sight distance, S , and the radius to the center of the inside lane, R , are known, the distance, M , is found by the following equation:

$$M = R[1 - \cos(28.65 S/R)]$$

If the radius, R , and the distance, M , are tentatively selected, then the length, L , of the arc in the middle of the inside lane may be found by the following equation:

$$L = (R/28.65) \arccos[(R-M)/R]$$

If the length, L , is less than the stopping sight distance for the desired speed, either the radius, R , or the distance, M , must be increased.

FIGURE 5-3.24 VIEW OBSTRUCTIONS AND HORIZONTAL CURVES

B. Reduced Design Speeds on Curves

The reduction of a street design speed on a curve should be avoided; however, where physical restrictions prohibit increasing the radius of the curve or the clear distance, "M" and/or provide superelevation; the design speed for the curved section may be reduced. In such circumstances, appropriate signage in accordance with the MUTCD is required. The difference between the design speed for the roadway approaching the curve and the design speed for the curve cannot be greater than 10 miles per hour. The design speed for a curved roadway section must not be reduced if the reduction occurs at the end of a long tangent or at any location where high approach speeds may be expected.

C. Compound Curves

Compound curves should be avoided; however, if site conditions make the use of compound curves unavoidable, the shorter radius needs to be at least 2/3 the length of the longer radius. Compound curves are not permitted when design speeds require the shorter radius to be greater than 1,000 feet.

D. Tangent Sections Between Curves in the Same Direction

On two-lane roads, tangent sections are needed between two curves in the same direction. If the pavement cross-sections throughout the curves do not have

superelevation then the minimum lengths for tangent sections are listed in Appendix 5-3A.

If superelevation is provided in the curved portions of the roadway, then the superelevation transition lengths indicated will determine the tangent lengths.

E. Tangent Sections Between Reverse Curves

Generally, a tangent section must be provided between two curves that curve in the opposite direction. Minimum lengths for tangent sections between reverse curves without superelevation are provided in Appendix 5-3A. If the curve radii are at least 50 percent greater than the radii required by the design speed, a tangent section may not be required depending on grades, topography and vegetation. If superelevation is provided for the curves, then the superelevation transition lengths indicated will determine the minimum length of tangent sections between reverse curves.

F. Tangent Sections Approaching Intersections

A tangent section must be provided between a street intersection and a curve unless otherwise approved by the Transportation Department. The minimum tangent length is shown in Appendix 5-3A and shall be measured from the end of the curve to the edge of the intersecting roadway.

VERTICAL ALIGNMENT

A vertical curve is required when grade changes are equal to or greater than 1.5 percent. All sections of a street's vertical alignment must meet passing and stopping sight distance requirements for the design speed established for the street. For specific details, refer to the AASHTO's Policy on Geometric Design.

A. Longitudinal Street Grades

For arterial streets, the maximum longitudinal grade is 6 percent. For non-ESL/Rural collector and local streets, the maximum grade is 9 percent. The minimum longitudinal street grade for all streets is 0.4 percent. Wherever possible, longitudinal street grades greater than the minimum grade are to be provided. Where necessary, grades less than 0.4 percent may be used with approval from the Public Works Department and/or Transportation Department. Grades that exceed the maximum longitudinal grades allowed may be used with approval from the Transportation, Public Works, and Fire Departments.

B. Vertical Curves

Properly designed vertical curves should provide adequate sight distance, safety and effective drainage.

1. Refer to AASHTO's Policy on Geometric Design of Highways and Streets for the equations that are to be used to determine the necessary parabolic vertical curve criteria.
2. Sight Distance Requirements
Sight distance is the continuous length of street ahead that is visible to the driver. For vertical alignment design, two sight distances are considered: passing sight distance and stopping sight distance. Stopping sight distance is the minimum sight distance to be provided at all points on multi-lane streets and on 2-lane streets when passing sight distance is not economically obtainable as approved by city staff. Stopping sight distance needs to be

5-3.121

provided near intersections. Appendix 5-3A lists the minimum stopping sight distances for the various design speeds.

a. Stopping Sight Distance

The minimum stopping sight distance is the distance required by the driver of a vehicle, traveling at a given speed, to bring the vehicle to a stop after an object on the road becomes visible. Stopping sight distance is measured from the driver's eyes, 3.5 feet above the pavement surface, to object 2.0 feet tall on the roadway, or per currently accepted AASHTO standards.

b. Passing Sight Distance

Passing sight is the minimum sight distance that must be available to enable the driver of one vehicle to pass another vehicle safely, without interfering with the speed of an oncoming vehicle. The sight distance available for passing at any one place is the distance at which a driver, whose eyes are 3.5 feet above the roadway surface, can see the top 0.8 feet of an object 4.35 feet tall on the road (corresponding to an object height of 3.5 feet tall), or per currently accepted AASHTO standards.

3. Minimum Vertical Curve Lengths

Minimum vertical curve lengths are determined by sight distance requirements for a given design speed.

a. Crest Vertical Curve Lengths

Minimum crest curve lengths are determined by either the stopping sight distance or the passing sight distance, whichever provides the greatest curve length. Refer to AASHTO's Policy on Geometric Design of Highways and Streets for the equations that are to be used to determine the minimum crest vertical curve lengths based upon stopping distance and passing sight distance requirements.

b. Sag Vertical Curve Lengths

Minimum sag vertical curve lengths are determined by either the stopping sight distance or comfort factors. The longer of the two possible minimum curve lengths will be used. Refer to AASHTO's Policy on Geometric Design of Highways and Streets for the equations that are to be used to determine the minimum sag vertical curve lengths based upon stopping distance and comfort factors requirements.

COMBINED CURVES

When horizontal and vertical curves are combined, the horizontal curve needs to lead and follow the vertical curve, and not be introduced near the top or bottom of a crest vertical curve or bottom of a sag vertical curve. For additional information on this topic, refer to the AASHTO's Policy on Geometric Design.

5-3.122

INTERSECTIONS

Although all intersections share certain common elements, they are not subject to generalized treatment. To minimize conflicts and provide for anticipated traffic movements, each intersection must be evaluated based on individual characteristics and designed based on the following factors:

5-3.123

- A. Traffic factors such as capacities, turning movements, vehicle size and operating characteristics, vehicle speed, pedestrian and bicycle movements, transit operations and collision history.
- B. Physical factors such as topography, existing conditions, channelization requirements and available sight distance.
- C. Human factors such as driving habits, reaction to surprises, decision and reaction time, and natural paths of movement.

Unless otherwise noted, intersection and street design for major collectors and arterial streets shall assume a WB-62 design vehicle as defined in AASHTO's A Policy on Geometric Design of Highways and Streets. There may be locations within or adjacent to heavy commercial or industrial areas where a WB-67 design vehicle may be required by Transportation staff.

For this section, the term "intersection" shall refer to the location where a public street meets or overlaps another public street, a private street, or a private driveway unless specifically noted otherwise.

A. Public and Private Street Intersection Spacing

Street intersections along major streets should be kept to a minimum. Along arterial streets, the minimum intersection spacing should be 1/4 mile (1320 feet). Along collector streets (major collectors and minor collectors), the minimum spacing should be 1/8 mile (660 feet). Along local streets (local residential and local collectors), the minimum spacing should be 250 feet. New intersections on major streets should be located to align with planned median openings. New intersections on minor streets should be located to avoid creating conflicting turning movements with existing intersections or driveways.

B. Angle of Intersection

A right-angle intersection provides the shortest crossing distance for intersecting traffic streams. It also provides the most favorable condition for drivers to judge the relative position and speed of oncoming vehicles. Where special conditions exist, intersection angles may diverge from a right-angle by a maximum of 2 degrees (up to 4 degrees with approval of the Transportation Department) on arterial streets and major collector streets; and by a maximum of 4 degrees (up to 15 degrees with approval of the Transportation Department) on minor and local collector streets, couplets and local streets.

C. Alignment and Profile

Intersections occurring on horizontal or crest vertical curves are undesirable. When there is latitude in the selection of intersection locations, vertical or horizontal curvature should be avoided. A line or grade change is frequently warranted when major intersections are involved. If a curve is unavoidable, it should be as flat as site conditions permit. Where the grade of the through roadway is steep, flattening through the intersection is desirable as a safety measure.

The maximum profile grade through an intersection is 6 percent for arterials and collector streets and 8 percent for local streets. The profiles and cross slopes of the intersecting streets need to be coordinated with one another to ensure a safe and comfortable driving surface. Typically, this may mean extending grades through

the intersection for approximately 75 feet to 150 feet. Short vertical curves may be necessary in lieu of grade breaks.

D. Intersection Sight Distance

To provide the opportunity for vehicles at an intersection to safely cross or make left or right turns onto a through street, adequate sight distance must be provided at all street intersections and where driveways intersect with streets. Sight distance must also be provided for left turning traffic turning from the main street as described in AASHTO Intersection Sight Distance Case F. If opposing left turn lanes are present, the opposing left turns must be designed having a positive off-set to allow for sight distance when opposing vehicles are present. Refer to Figure 5-3.28.

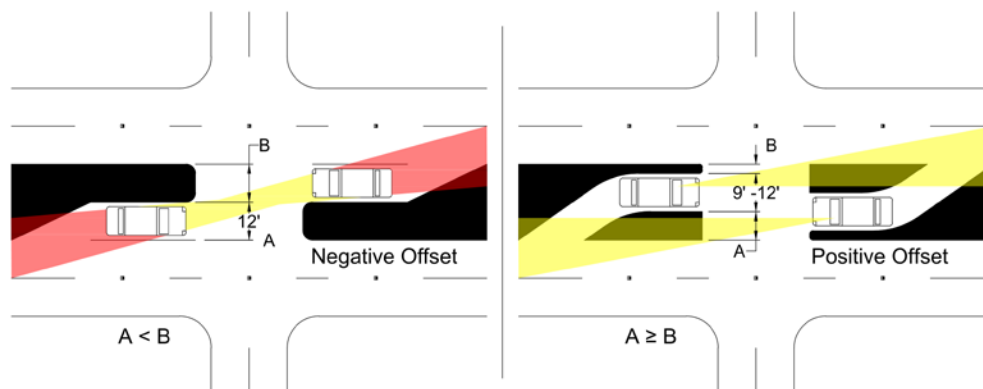
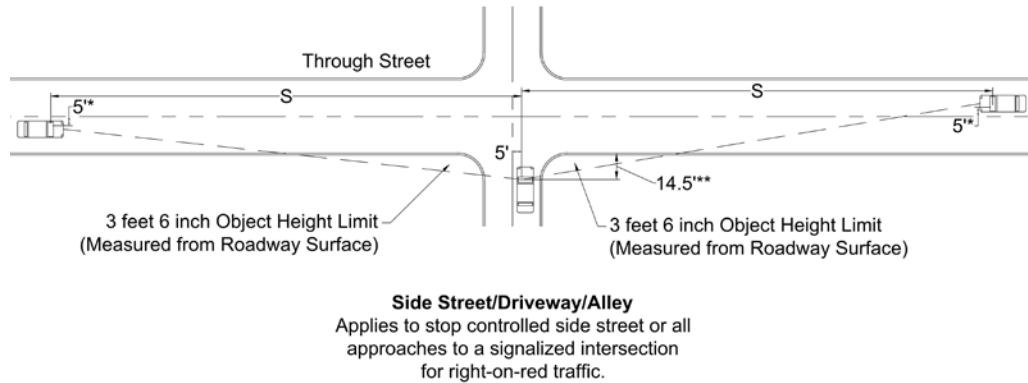

FIGURE 5-3.25 INTERSECTION DEPARTURE SIGHT DISTANCE REQUIREMENTS

Sight distance should be based on the design speed for the roadway. Design speeds for new roadways should conform to those identified in Section 5-3.100. Typically design speeds are 10 mph higher than the anticipated posted speed limit. The sight distance requirements outlined below are required for all private and public street intersections and at all intersections of driveways onto public or private streets. These standards do not apply to driveway intersections located on private property and that are internal to the private property and that do not intersect with streets.

Figure 5-3.29 depicts the technique used to determine the driver's eye location and an approaching vehicle; a line is then drawn to connect these 2 points. Continuous unobstructed line of sight must be provided along this line and throughout the approach to the intersection, providing an unobstructed sight triangle to the side street driver. Sight lines are to be drawn on roadway and landscaping plans to represent the areas that must be free of all objects and topography more than 2.5 feet above the adjacent roadway surface (edge of pavement); however, certain vegetation may be allowed. Vegetation placed within the sight triangle will be of a low height variety that remains below 2.5 feet when mature (measured from the roadway surface). Trees may be allowed within the triangle if the canopies are above 8 feet, they are a single trunk variety, and they are not spaced in a configuration that creates a "picket fence" effect.



* 5 feet measured to nearest lane line or centerline.

** 14.5 feet measured from face-of-curb or edge-of-travel way.

S = Intersection sight distance in feet on driver's left and right for right turns, left turns and through traffic.

(See AASHTO Geometric Design of Highways and Streets for additional sight distance requirements)

(See, Appendix 5-3B for distance S)

FIGURE 5-3.26 INTERSECTION DEPARTURE SIGHT DISTANCE REQUIREMENTS

1. Intersection sight distance requirements are as follows:
 - a. Right-Angle Intersections

Right-angle intersections are those whose legs meet at an angle of 88 to 90 degrees. For these right-angle intersections the sight distances shown in and Appendix 5-3B are to be used with Figure 5-3.29 to calculate the sight triangle. Appendix 5-3B presents the sight distance requirements for varying roadway widths and design speeds for passenger cars, single unit trucks and combination trucks. If high volumes of truck traffic are anticipated, sight distances given in Appendix 5-3B will be used. Sight distances for vehicles turning left from the main street should also be considered and calculated based on the AASHTO Geometric Design of Highways and Streets.
 - b. Skewed Intersections

For skewed intersections where the intersection angles are less than 88 degrees, sight distances must be calculated in accordance with the procedures described in AASHTO's Geometric Design of Highways and Streets. Skewed intersection design must include appropriate design for pedestrian crossings and the location of curb ramps.
 - c. Intersections Within or Near a Curve

Sight distance measurements, identified in Figure 5-3.30 need to follow the curved street alignment when the intersection is within or near a horizontal curve.
2. Traffic Safety Triangles

Traffic Safety Triangles should be used to limit the height of structures, vegetation and other improvements on corner properties immediately adjacent

to all street intersections and where driveways intersect with streets. Safety triangles are not to be used as a substitute for intersection sight distance. Safety triangles provide additional visibility around corners for all intersection approaches and should be applied to the design of walls and landscape features. Fixed objects within the safety triangle cannot be taller than 2.5 feet measured from the adjacent roadway surface (edge of pavement); vegetation should be trimmed to 2.5 feet tall measured from the adjacent roadway surface. Figure 5-3.30 Traffic Safety Triangle on Corner Property depicts the method used to determine the safety triangle location. The safety triangle will follow the curvature of the roadway/right-of-way along curved roadway alignments. The sight distance requirements contained in both Figure 5-3.29 and Figure 5-3.30 are applied at all corner lots.

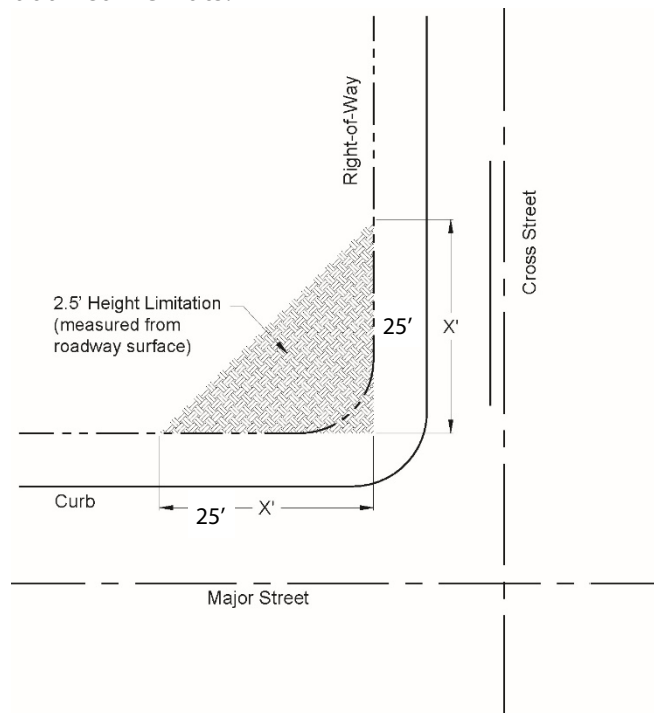

* If the standard right-of-way (46 ft. local residential, 60 ft. local collector) is not available, the safety triangle (X) shall measure 60 ft. on local residential streets and 70 ft. on local collector streets from the centerlines of the streets.

FIGURE 5-3. 27 TRAFFIC SAFETY TRIANGLE ON CORNER PROPERTY

3. Right-of-Way at Corners

A minimum of 25-foot radius or 25-foot by 25-foot triangle right-of-way shall be dedicated at street intersections to provide room for traffic control and sight distance.

E. Auxiliary Lanes

An exclusive turning lane permits separation of conflicting traffic movements and removes turning vehicles from the flow of through traffic. The requirement for an auxiliary lane may necessitate additional rights-of-way. Modifications to these requirements, including the storage and transition lengths may be allowed by the Transportation Department where the conditions do not allow the full design standard to be met.

1. Right-Turn Lanes

Right-turn lanes are required at all street intersections (public or private) on major arterials. Right-turn lanes may be required by the Transportation Department on minor arterial and collector street intersections. The lane lengths should be determined based on the anticipated turning volume and whether there is signalized or unsignalized traffic control. The standard vehicle storage length for a right-turn lane is 150 feet, with a 100-foot minimum length. Right turn lanes should be 11 feet wide. Refer to City of Scottsdale Standard Detail #2225 for taper and radius dimensions.

2. Left-Turn Lanes

Left-turn lanes are required at all street intersections on major collectors and arterials. Left-turn lanes may also be required at street intersections on minor collectors based on the projected left-turn volume and conflicting through volume. The lane lengths should be determined based on the anticipated turning volume and whether there is signalized or unsignalized traffic control. For left-turn lanes at signalized intersections, dual turn lanes should be considered when the turn volume exceeds 300 vehicles per hour, the opposing through volume exceeds 1,000 vehicles per hour, or the delay to left turning vehicles exceeds 45 seconds. Sight distance must be considered and calculated for these movements based on the AASHTO Policy on Geometric Design to determine the allowance of permitted left turns. Left-turn lane widths should be 11 feet however can be narrowed to a minimum of 9' to provide positive offset. Refer to Figure 5-3.28. Refer to City of Scottsdale Standard Detail #2225 for taper and radius dimensions.

3. Local Street Intersections with Major Streets

At intersections of local streets with major streets (Major Collectors, Minor Arterials, and Major Arterials) the pavement width shall widen to a minimum width of 36 feet to provide for a separate left turn. The 36-foot pavement width shall be provided for a minimum length of 100 feet from the right-of-way line with an appropriate taper length as approved by Transportation staff.

F. Median Design

Raised medians are required on arterial streets and some major collector streets to separate traffic flows, channelize left turns and reduce conflicts. On most collector streets, flush or painted medians provide space between the through traffic lanes for left turning vehicles. Standard median widths are shown in Figure 5-3.31 through Figure 5-3.34. Variations to these standards may be approved through the master plan process or by the Transportation Department.

1. Raised Medians and Median Openings

Raised medians, where required, must be provided in accordance with the applicable city standard details, with the appropriate median width as noted above.

- a. Spacing and Location of Median Openings

If a street has a raised median, it is not possible to provide an opening in the median for every street intersection or driveway location. Full median openings should occur at not less than 1/4-mile intervals (1320 feet) on

major arterial streets. Partial median openings, which allow only left turns off the major street, are acceptable at 1/8 mile spacing (660 feet). On minor arterials, full median breaks should be no closer than 1/8-mile intervals with preferable 1/4 mile spacing. In built up areas, where reasonable alternate access is not available, median openings may be provided at smaller intervals with the approval of the Transportation Department.

b. Configuration of Median Openings

If the street intersection legs intersect at an angle of 88 to 90 degrees, the configuration of the median opening will be determined by the information shown below on Figure 5-3.31. If the streets intersect at angle less than 88 degrees, the median opening configuration will have to be determined to the satisfaction of the Transportation Department.

c. Cross-Slope

The cross-slope in the median opening is limited to 0.02 ft/ft. Median openings on curves with superelevation exceeding 0.02 ft/ft will not be permitted.

2. Flush Medians

Flush, painted medians are required on major and minor collector streets without raised medians.

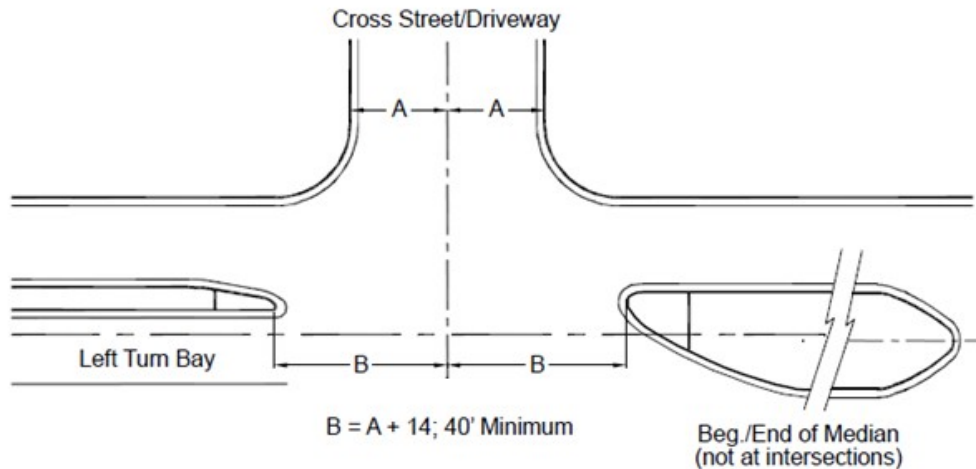

Notes:

1. This sketch is for a three leg intersection. If the intersection has four legs, the right side will also have an auxiliary lane for left turns, and the median on the right side will have the same configuration as the one on the left side rotated 180 degrees.
2. See COS Standard Details for median dimensions.

FIGURE 5-3.28 MEDIAN OPENINGS FOR INTERSECTIONS

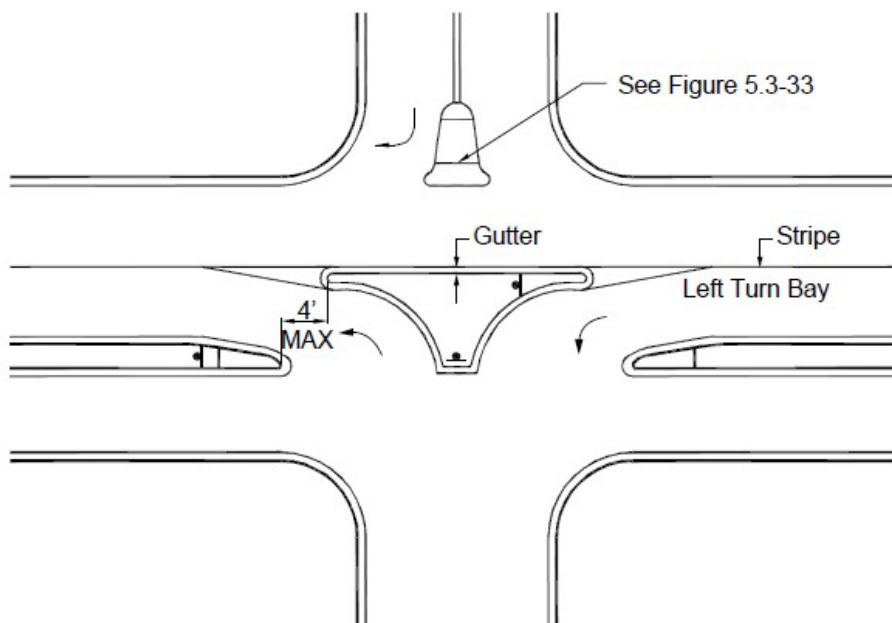

Note: Curbs may be vertical, rolled or painted to match existing roadway design or construction.

FIGURE 5-3.29 LEFT IN / LEFT OUT MEDIAN OPENINGS FOR INTERSECTIONS

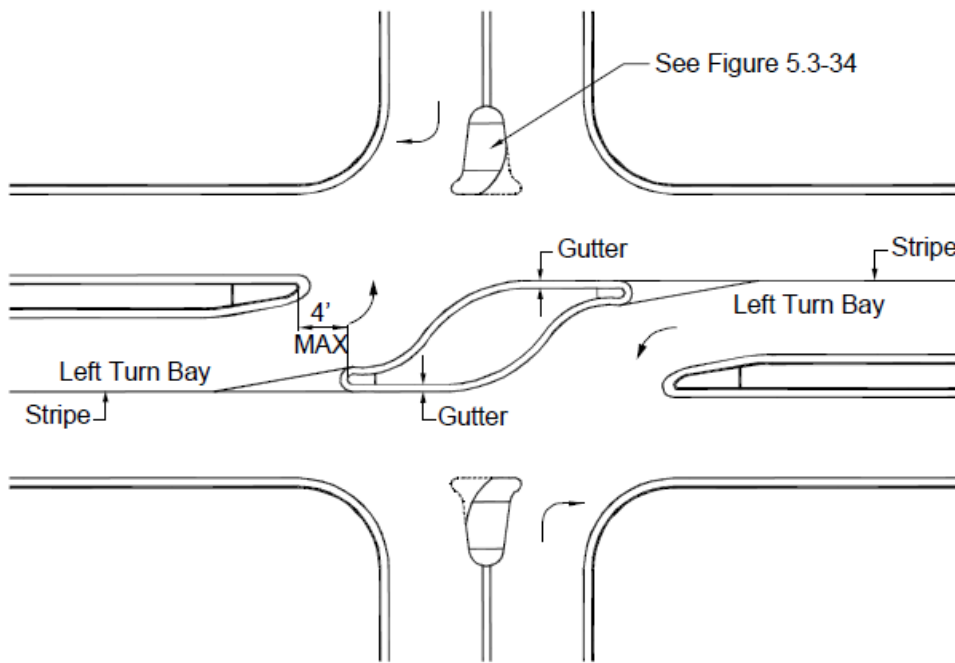

Note: Curbs may be vertical, rolled or painted to match existing roadway design or construction.

FIGURE 5-3.30 LEFT IN / LEFT IN MEDIAN OPENINGS FOR INTERSECTIONS

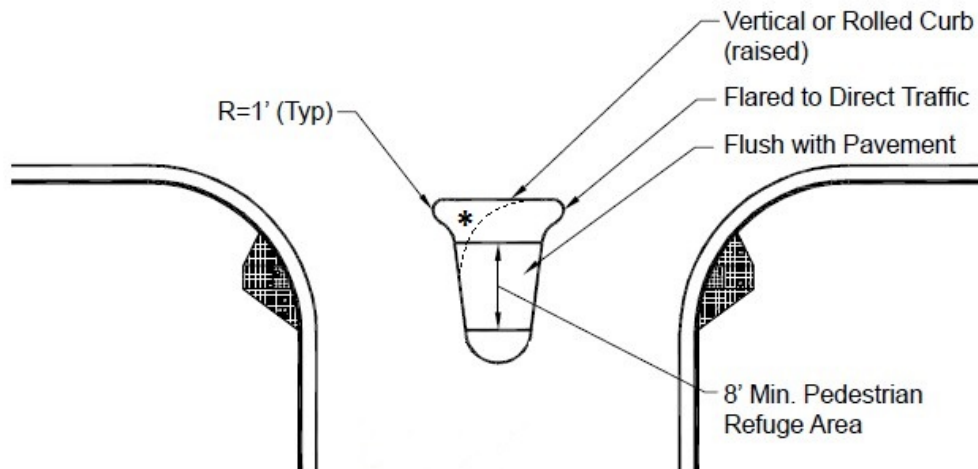

Note: Area of entire island must be a minimum of 30'.

*If left-in allowed, modify island accordingly

FIGURE 5-3.31 RIGHT IN / RIGHT OUT MEDIAN WITH PEDESTRIAN REFUGE

G. Traffic Control

Traffic control at all new intersections should initially be stop controlled on the minor street. Any higher means of traffic control, four-way stop, or a traffic signal

will require approval by Traffic Engineering based on an approved engineering study.

Guidelines for four-way stop and traffic signal-controlled intersections are outlined below. Intersections of local residential streets within subdivisions are assumed to be stop controlled and will typically not need signage.

1. Four-way Stop Controlled Intersections

Four-way (or multi-way) stop controlled intersections are allowed only when based on an engineering study approved by the Traffic Engineering based on the criteria contained in the MUTCD. Four-way stop control is generally utilized for the intersections of two similar classification streets where volumes are approximately equal or at intersections where there is a safety concern (such as limited sight distance). In many cases roundabouts are better solutions as they provide significantly more volume capacity, reduce emissions and gas use, reduce delays and are self-enforcing. On new intersections a roundabout shall be considered prior to consideration being given to installing an all way stop controlled intersection.

2. Traffic Signal Controlled Intersections

- a. Traffic Signal Warrants

New traffic signal-controlled intersections are allowed only when based on an engineering study approved by Traffic Engineering using MUTCD criteria. Traffic signals warrants are generally based on existing traffic volumes, not projected traffic volumes. Contributions for future traffic signal construction are required for developments that are located at major intersections where traffic signal control is anticipated. Payment toward future construction should not be interpreted to mean a traffic signal is warranted. New intersections where a traffic signal is anticipated will require a preliminary traffic signal design to determine the proper location for the installation of underground conduit and pull boxes.

- b. Traffic Signal Spacing

Traffic signals should be spaced no less than 1/2 mile on major arterials and minor arterials, with 1 mile spacing desirable. Traffic signals should be spaced no less than 1/4 mile on collector streets, with 1/2 mile spacing desirable. Reduced spacing will interfere with traffic progression and signal coordination. Any deviation from these standards requires approval from the Transportation Department based on an approved study that indicates no significant deterioration in traffic progression.

3. Roundabouts

Roundabouts are an appropriate substitution for multi-way stop control and signalization. Roundabouts are most appropriate at locations with high turning movements, where the intersecting street traffic volume on the major street is less than ten times the volume on the minor street, and where safety is a primary concern. At Minor Collector/Minor Collector (or smaller designated streets) intersections the designer shall first evaluate using a roundabout as an alternative to a multi-way stop or traffic signal for all new intersections or significantly rebuilt intersections. At Minor Arterial/Minor Arterial (or smaller

designated streets) intersections the designer should evaluate using a roundabout as an alternative to a traffic signal for all new or significantly rebuilt intersections.

H. **Intersections with an Unpaved Leg**

If an intersection has a leg that is unpaved, the paving shall extend to the end of the normal curb return location on the unpaved leg (at a minimum) with a desired length of 50 feet from the edge of the roadway.

I. **Valley Gutters at Street Intersections**

Valley gutters may only be used across minor and local collector streets and local residential streets. Exceptions must be approved by the Transportation Department. Valley gutters should be constructed in accordance with city standard details and should consider the design speed of the affected streets.

ROUNDBABOUTS

5-3.124

A. **Roundabout Intersections**

Roundabouts reduce accidents and improve traffic flow at intersections. The city considers the use of roundabouts on a case by case basis. Roundabouts are typically used as an alternative to traffic signals or four-way stop control. Roundabout design must follow the most current guidelines for roundabouts, including proper treatment of pedestrian crossings, bicycle lanes and signage. Refer to Figure 5-3.35 for Roundabout Design, Figure 5-3.36 for Signing and Markings, and Figure 5-3.37 for sight distance.

Refer to the FHWA's Roundabouts: An Informational Guide (Publication No. FHWA-RD-00-67) and the Manual on Uniform Traffic Control Devices for further information.

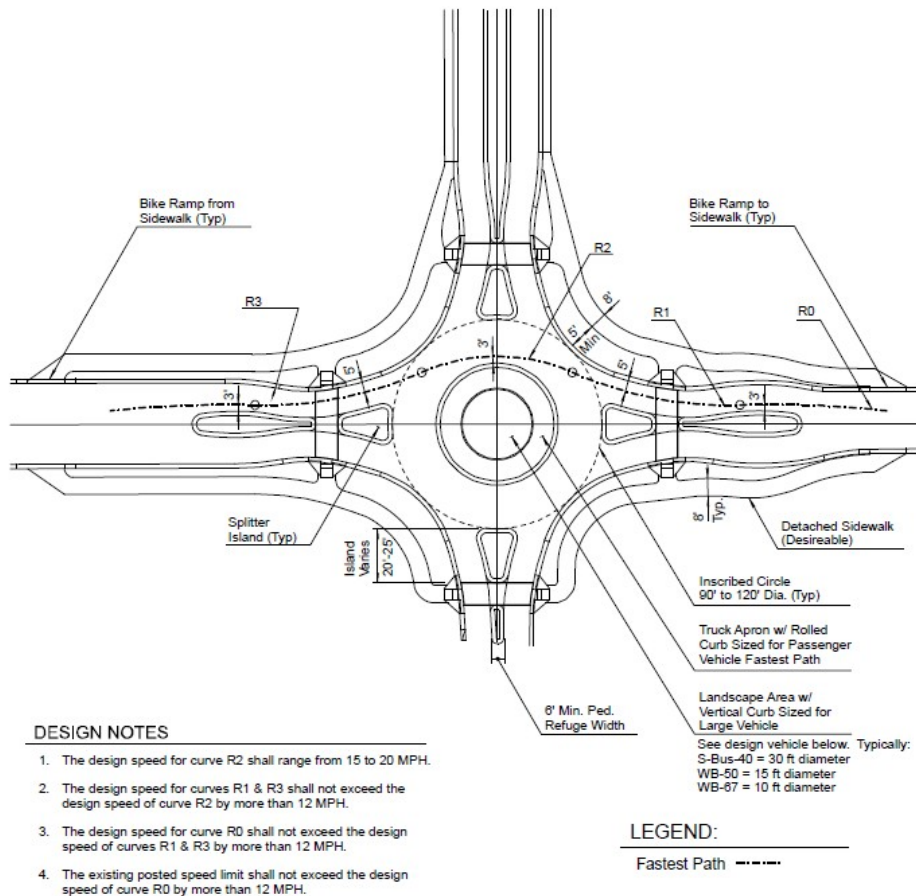

FIGURE 5-3.32 ROUNDABOUT DESIGN

Main Design Considerations:

1. Design all legs to yield to traffic in roundabout.
2. Provide channelized approaches/splitter islands for all legs.
3. Design geometry to slow speeds to less than 25 mph.
4. Discourage pedestrian crossing to the center island.
5. Provide pedestrian refuge in splitter islands.
6. Local or minor collector intersections with less than 5,000 vpd shall accommodate an S-Bus 40 (which will accommodate fire trucks, sanitation trucks and most large residential trailers) for all turning movements and should accommodate a WB-62 for through movements to prevent errant vehicles from getting stuck.
7. Minor collectors and up with over 5,000 vpd shall accommodate a WB-62 (which will accommodate fire trucks, sanitation trucks and most trailers) for all turning movements and should accommodate a WB-67 for through movements to prevent errant vehicles from getting stuck.
8. Truck Apron (rolled curb/interior designed for passenger car path, vertical curb exterior designed for truck path). Truck apron shall NOT look like the sidewalk and should discourage pedestrian use through design.
9. Slow vehicles prior to the circle using curve to produce fastest path radii R1, R2, R3, refer to Figure 5-3.35.

10. R2 fastest path of 15 to 20 mph.
11. R1 should be within 12 mph of R2 and posted or 85th percentile speed. If R1 is not within 12 mph of posted or percentile, consider an "R0" prior to R1.
12. Use splitter islands (rolled curb typical).
13. Splitter island (6-foot minimum width and length at pedestrian refuge; 10-foot preferred) and tangent to inner circle. Separate sidewalk away from curb near circle to encourage crossing at splitter crossing.
14. Allow bikes to merge with vehicular traffic or exit to sidewalk/path or trail as available.
15. Provide a bike ramp for bikes where the splitter island starts (or before the R1) so they have the option of using sidewalk or mixing with the vehicles.
16. Single lane circulating roadway is typically 14 to 16 feet wide.
17. Single lane inscribed circle is typically 90 to 120 feet in diameter.
18. Geometric layout should be checked with Auto Turn or by similar method.
19. Intersection circle and splitter islands should follow the forgiving roadway design principles as described in the AASHTO Roadside Design Guide and should avoid structural elements that could likely be in the path of an errant driver.
20. The six major geometric design parameters for roundabouts, as defined by FHWA, shall comply with TRB's NCHRP Report 672 "Roundabouts: An informational Guide – Second Edition."

Additional guidance can be found in the MUTCD published by the FHWA and in the TRB's NCHRP Report 672 "Roundabouts: An informational Guide – Second Edition".

B. Typical Signage

1. All-Way Yield.
2. Supplemental Yield in splitter/median.
3. MUTCD recommended "chevron" signs in center island to line up with driver.
4. Pedestrian crossing signs back-to-back in splitter/median.
5. Advance roundabout warning sign with street name plaque per MUTCD.
6. Street Name directional plaque at roundabout exit within splitter/median.

C. Typical Lighting (minor collector or greater)

1. Minimum 2 lights for single lane approaches
2. Minimum 4 lights for major collector or greater

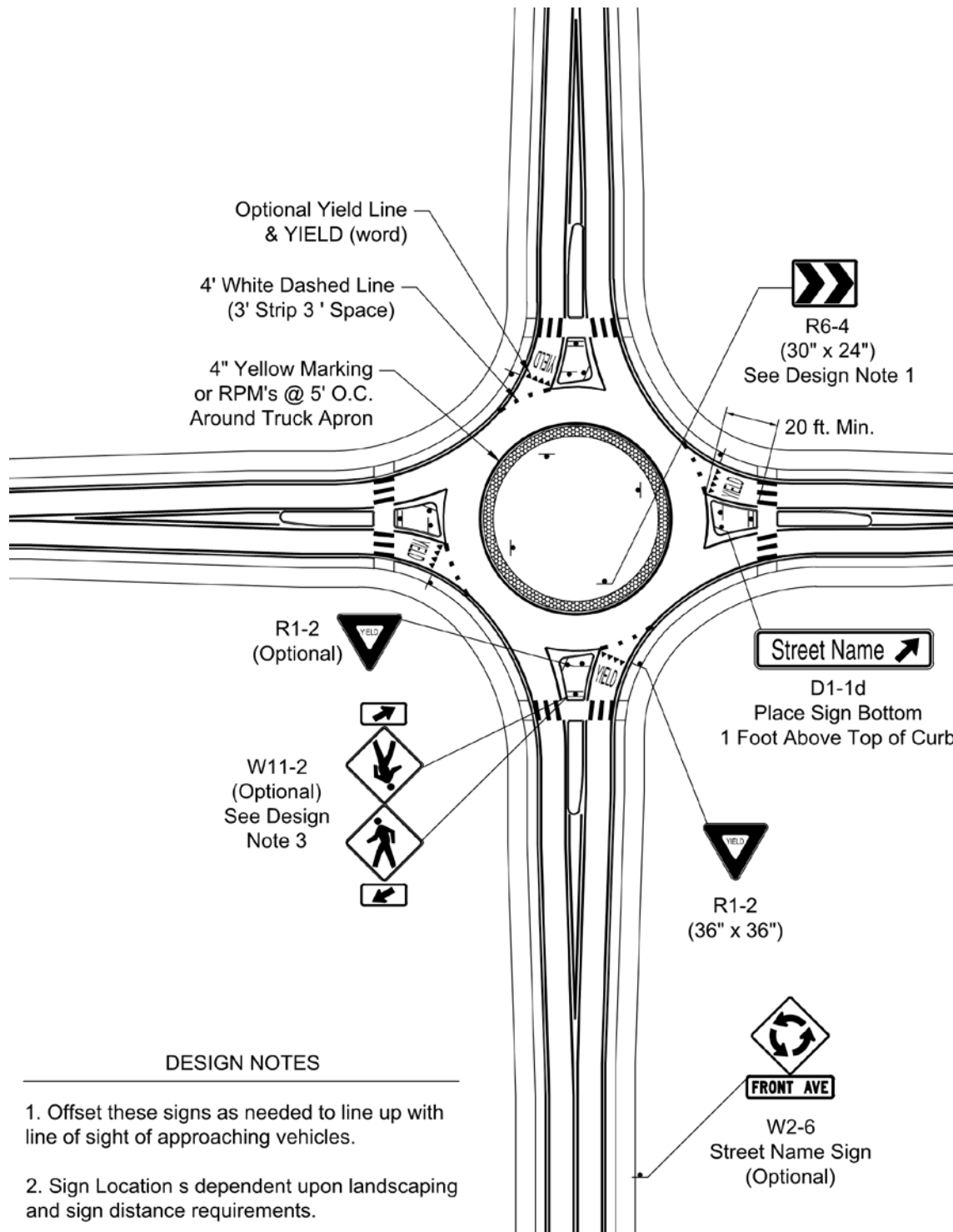

FIGURE 5-3.33 ROUNDABOUT SIGNING AND MARKINGS

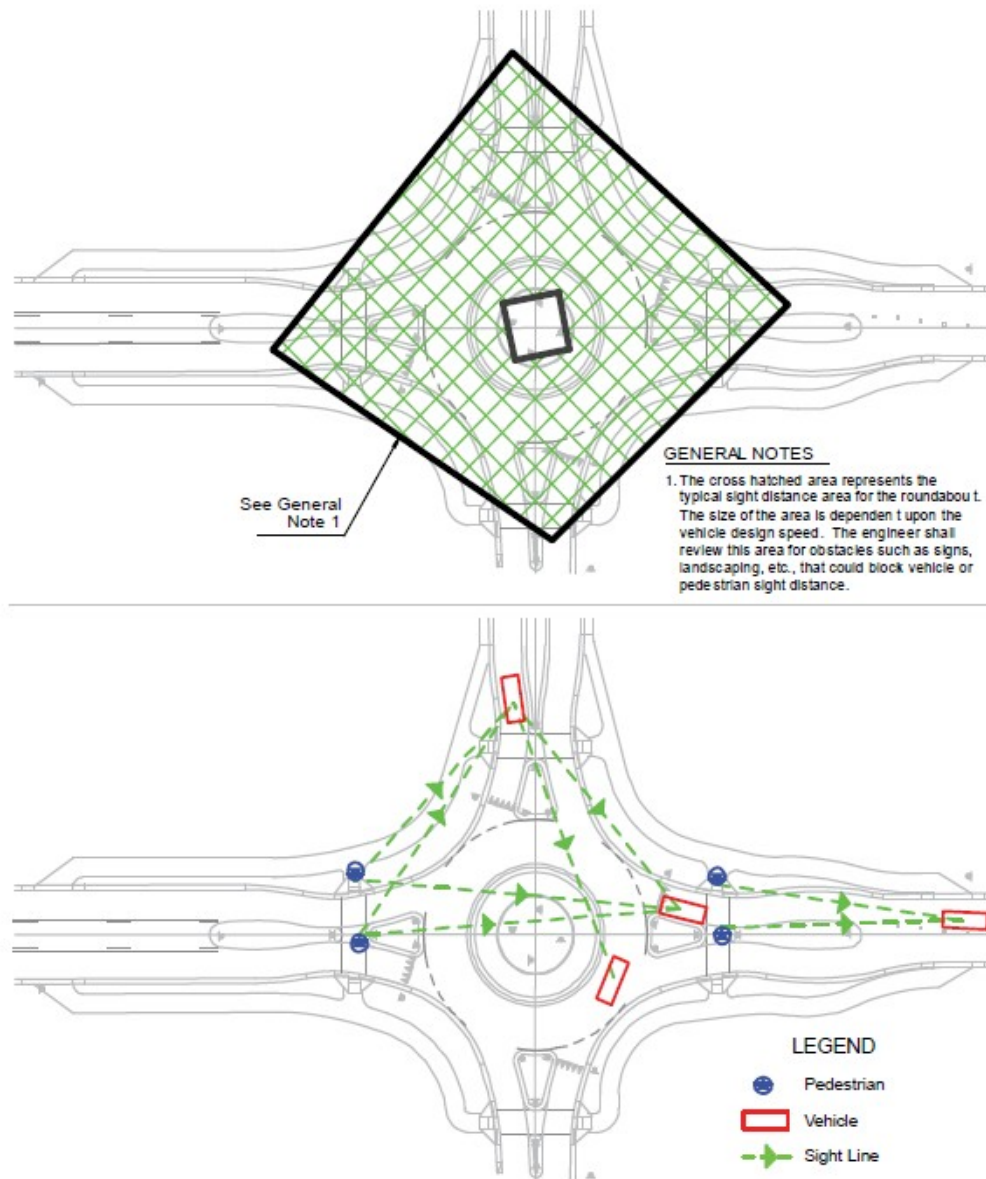

FIGURE 5-3.34 ROUNDABOUT SIGHT DISTANCE

STREET ACCESS AND DRIVEWAYS

5-3.2000

Driveway types are determined by land use type and street classification. The standards for these driveway types are illustrated in Figure 5-3.38 through Figure 5-3.43. Refer to Figure 5-3.39 for driveway grade standards.

DRIVEWAY SPACING

5-3.201

Standard and minimum driveway spacing will generally conform to the following standards. This minimum spacing applies to proposed site driveway separation as well

as separation from existing or planned driveways and streets on adjacent parcels. The spacing is measured to the driveway or street centerline.

STREET TYPE	STANDARD DRIVEWAY SPACING	MINIMUM DRIVEWAY SPACING
Local Residential / Local Collector	50 feet	50 feet
Local Industrial / Local Commercial	165 feet	125 feet
Minor Collector	165 feet	125 feet
Major Collector	250 feet	150 feet
Minor Arterial	330 feet	250 feet
Major Arterial	500 feet	300 feet

FIGURE 5-3.35 DRIVEWAY SPACING

Standard driveway spacing criteria shall apply for all new driveways where there are no conflicts with existing driveway and street intersections, site frontage is adequate, and there are no conflicts with natural features or drainage structures. The minimum driveway spacing may be allowed when approved by Transportation staff where those conflicts noted above exist or other site plan associated issues do not allow the standard driveway spacing to be implemented. In locations where the standard driveway spacing cannot be achieved, a deceleration lane may be required to mitigate the impact of the closer driveway spacing.

For sites that have frontage on two streets, primary access should be onto the minor street frontage. A maximum of two driveway openings is permitted to a site or parcel from the abutting street(s). The Transportation Department may permit additional driveway entrances when projected travel demands indicate it is in the interests of good traffic operation, and when adequate street frontage exists to maintain the above guidelines.

Where new development adjoins other similarly zoned property or compatible land uses, a cross access easement may be required to permit vehicular movement between the parcels or to reduce the number of access points required onto the adjacent public street. Combining driveways reduces the number of conflict points for pedestrians, bicyclists, and other vehicles. This may be required regardless of the development status of the adjoining property, unless the cross access is determined to be unfeasible by city staff.

New driveways on collector and arterial streets in areas that do not have raised medians shall align with existing or planned driveways and street intersections to avoid creating interlocking left turns and other conflicts. Offsets in the driveway centerlines may be allowed up to 6 feet. If the driveways cannot be aligned, the driveways should be offset a minimum distance of 125 feet along streets without a center turn lane, and a minimum 250 feet along streets with a center turn lane.

When site driveway locations are modified, any existing driveways that are not going to be utilized for access must be removed and replaced with curb, gutter, and sidewalk to match the adjacent improvements.

DRIVEWAY LOCATIONS

5-3.202

A new access driveway will not be allowed (measured to the driveway centerline):

- A. Within 30 feet of any commercial property line, except when it is a joint-use driveway serving two abutting commercial properties and access agreements have been exchanged between, and recorded by, the two abutting property owners;
- B. When the total width of all driveways serving a property exceeds 50 percent of the curb line frontage;
- C. Within 50 feet of the rights-of-way line of an intersecting non-arterial street;
- D. Within 100 feet of the rights-of-way line of an intersecting arterial street;
- E. Within 100 feet of an approved median opening location on an arterial street;
- F. Less than the minimum spacing as established under Section 5-3.201;

VEHICULAR NON-ACCESS EASEMENT

5-3.203

For proper control of driveway access, a vehicular non-access easement (V.N.E.) is to be granted to the city, except at approved access points, along all collector and arterial streets when abutting property develops.

RESIDENTIAL DRIVEWAYS

5-3.204

A. **Single-family Residential Development**

Driveways serving single-family residential units should be S-1 type driveways as shown in Figure 5-3.40. Only one driveway per lot street frontage is allowed except where the street frontage is of sufficient length to maintain a separation of 50 feet between driveways. The minimum driveway length is 18 feet, measured from the face of the garage opening to the back of sidewalk or the back of curb if no sidewalk is provided. Refer to Section 2-2.308 for additional discussion on driveways. Refer to Standard Detail Drawings (2200 Series) for access ramp design requirements.

B. **Multi-family Residential Development**

Driveways serving multi-family residential units should be CL and CH type driveways, as shown in Figure 5-3.41 through Figure 5-3.44. Type CL-1 and CL-2 are low-volume driveways to be used on local streets. Type CH-1, -2 and -3 are high volume driveways to be used on collector and arterial streets. CL type driveways may be required along urban character collector and arterial streets with higher pedestrian traffic. The minimum driveway length is 50 feet, measured from the entrance to the off-street parking area to the back of sidewalk, or to the back of curb if no sidewalk is provided. Refer to Standard Detail Drawings (2200 Series) for access ramp design requirements.

C. **Limitations on Residential Access**

Residential properties that have frontage on a local street, an arterial, or collector street are limited to local street access.

In some instances, residential parcels fronting only on arterial or collector streets may be given access if alternate public access is not available. When such access is allowed, the driveway must be circular, or it must have a turn-around area to ensure there is no need for backing onto the street.

NON-RESIDENTIAL DRIVEWAYS

Driveways for commercial and industrial development are shown on Figure 5-3.41 through Figure 5-3.44. The minimum length for a commercial or industrial driveway is 50 feet, measured from the entrance to the off-street parking area to the back of sidewalk or the back of curb if no sidewalk is provided. Driveway designs need to include a level path of travel across the driveway for pedestrians in conformance with ADA requirements.

A. **Commercial Driveways**

The "CL" and "CH" type driveways are designed to serve commercial properties. A "CL" type driveway is used for low-volume driveways on low volume streets. A "CH" type driveway is used for driveways on arterials, major collectors and high volume minor collectors, or at other locations when required by the Transportation Department. The CH-2 and CH-3 driveways are used at all access driveways opposite median openings. CL type driveways may be required along urban character collector and arterial streets with higher pedestrian traffic. Refer to Standard Detail Drawings (2200 Series) for access ramp design requirements.

B. **Industrial Driveways**

The CL-1 and CH-1 type driveways are typically used to serve industrial properties. Normally industrial access is not permitted on arterial or major collector streets; however, if such access is allowed, commercial driveway standards apply. Refer to Standard Detail Drawings (2200 Series) for access ramp design requirements.

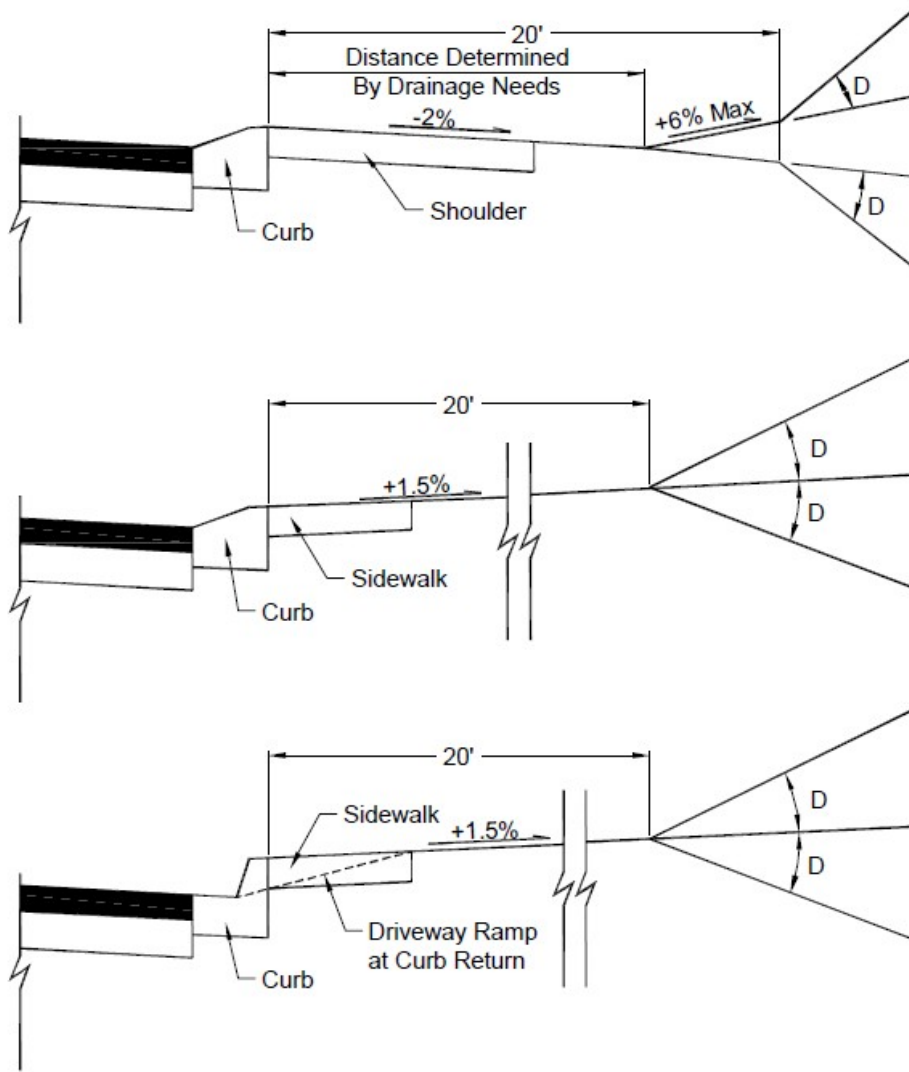

A.D.T. For Driveway		Grade Difference, D	
		Desirable	Maximum
Low Volume	1-500	6%	10%
Medium Volume	500-1500	3%	10%
High Volume	1500 or More	0%	10%

3.36 DRIVEWAY GRADE STANDARDS

FIGURE 5-

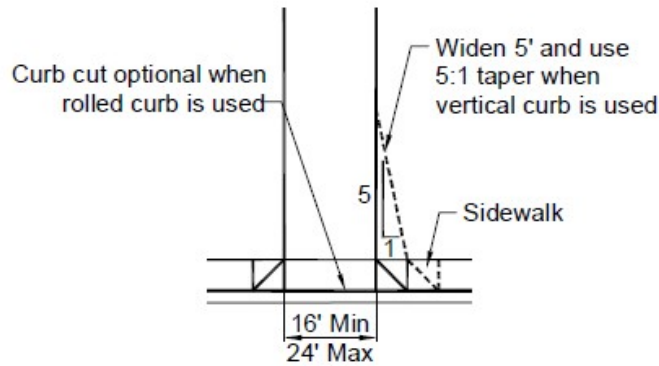

Suburban Single Family Unit

NOTE: See COS Standard Details for more specific information.

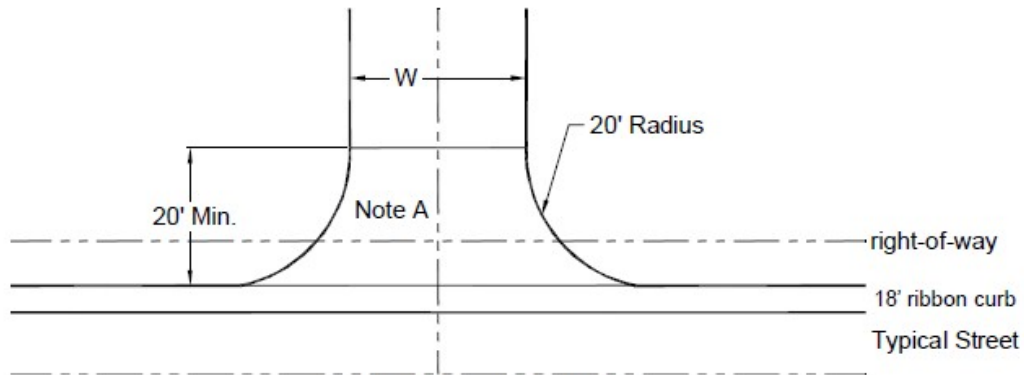

Rural/ESL Single Family Unit

- W=16' for driveway serving one lot
- W=24' for driveway serving two lots
- Note A: Pavement section-2" A.C/6" A.B.C. Minimum

FIGURE 5-3.37 TYPE S-1 DRIVEWAY STANDARDS

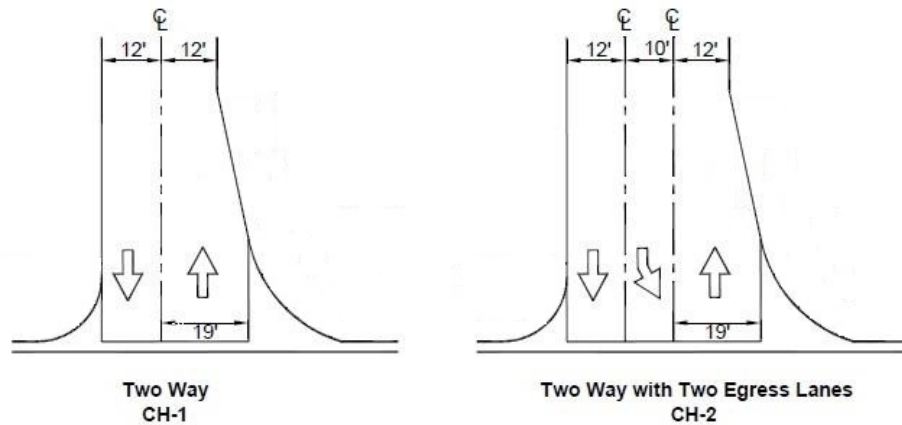

*Note: Pedestrian ramps in this figure are illustrative only and should be designed and constructed per COS Supplement to MAG Details.

FIGURE 5-3.38 TYPE CH TWO-WAY DRIVEWAYS

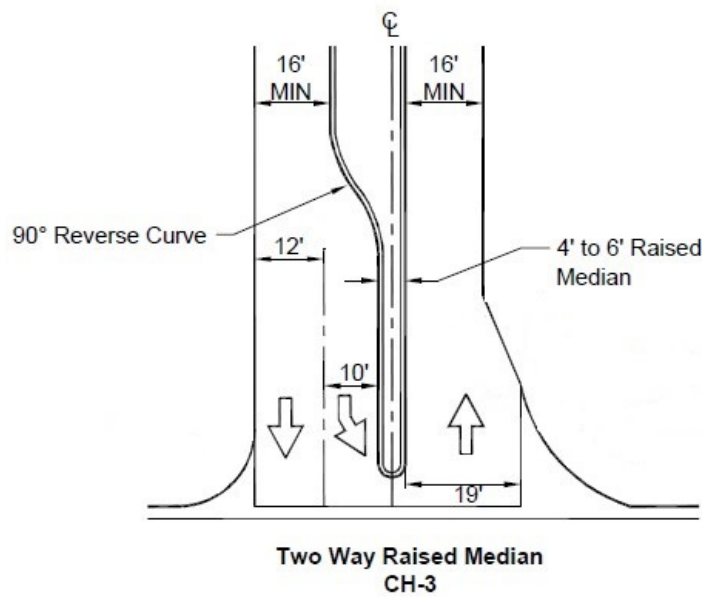

*Note: Pedestrian ramps in this figure are illustrative only and should be designed and constructed per COS Supplement to MAG Details.

FIGURE 5-3.39 TYPE CH TWO-WAY DRIVEWAYS WITH RAISED MEDIAN

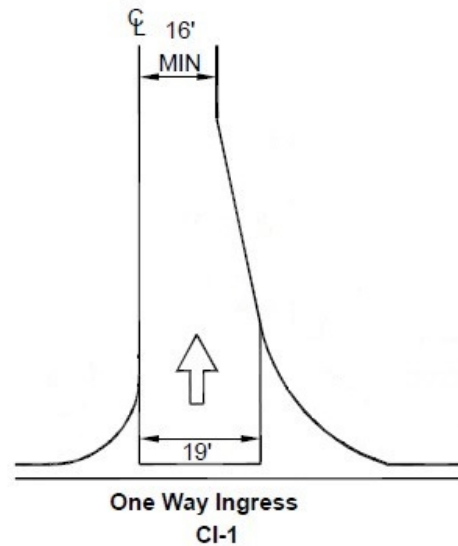

*Note: Pedestrian ramps in this figure are illustrative only and should be designed and constructed per COS Supplement to MAG Details.

FIGURE 5-3.40 TYPE CL ONE-WAY INGRESS DRIVEWAYS

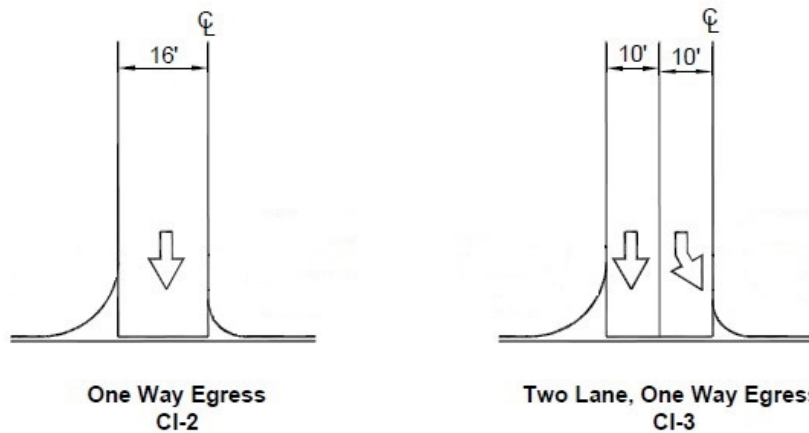

*Note: Pedestrian ramps in this figure are illustrative only and should be designed and constructed per COS Supplement to MAG Details.

FIGURE 5-3.41 TYPE CL ONE-WAY INGRESS DRIVEWAYS

DECELERATION LANES

The requirement for an auxiliary lane may necessitate additional rights-of-way. The standard storage length for a deceleration lane is 150 feet, with a 100-foot minimum length. Modifications to the design standard are allowed by the Transportation Department where the conditions do not allow the full taper or storage length. Deceleration lanes are required at all new driveways on major arterials and at new commercial/retail driveways minor arterials. Deceleration lanes for driveways may also

5-3.206

be required on collector streets and for non-commercial/retail driveways on minor arterials. The lane length should be based on the distance needed to allow the vehicle to exit the through lane and slow to a 15-mph travel speed. To determine the need for a deceleration lane on streets classified as a minor arterial or collector, use the following criteria:

- A. At least 5,000 vpd are expected to use the street;
 - B. The 85th percentile traffic speed on the street is at least 35 mph;
 - C. At least 30 vehicles will make right turns into the driveway during a 1-hour period.
- Deceleration lanes may be required at driveways along collector and arterial streets that are at or over capacity to minimize the impacts to traffic flow along the adjacent street. They may also be required at driveway locations that cannot meet the standard driveway spacing to reduce the impacts of the separation from closely spaced streets and driveways.

The requirement for deceleration lanes may be subject to the Transportation Department review in urban areas and where conflicts with deceleration lane(s) exist.

BRIDGES, RETAINING WALLS, AND STRUCTURAL CLEARANCES

5-3.300

BRIDGES

5-3.301

A. **Bridge Roadbed Width**

The clear width of all bridges, including grade separation structures, needs to equal the full width of the physical improvements consisting of sidewalk, street, median and curb and gutter.

B. **Approach Guardrail**

If a vehicular railing or safety-shaped barrier is within the clear zone as defined by AASHTO Roadside Design Guide, approach guardrails are to be installed on all approach ends in accordance with AASHTO guidelines and the below paragraph, E. Railings.

C. **Cross Slope**

The crown is normally centered on the bridge except for one-way bridges, where a straight cross slope in one direction is used. The cross slope needs to be the same as for the approach pavement.

D. **Median**

On multi-lane divided highways, a bridge median that is 26 feet wide or less needs to be decked. The decking of all medians greater than 6 feet wide needs to be grated to allow natural light into the structure. Exceptions must be submitted to the Transportation Department for approval.

E. **Railings**

The length of the railing should be calculated as part of the design process. The railings to be used are the State of Arizona or State of California Department of Transportation standard design railings. There are four types of railings:

1. Vehicular Barrier Railings

The primary function of these railings is to retain and redirect errant vehicles.

2. **Combination Vehicular and Pedestrian Railings**
These railings perform the dual function of retaining both vehicles and pedestrians on the bridge. They consist of two parts:
 - a. A concrete barrier railing with a sidewalk, and
 - b. A metal hand railing or fence-type railing (must be ADA compliant).
3. **Pedestrian Railings**
These railings prevent pedestrians from accidentally falling from the structure and, in the case of the fence-type railing, prevent objects from being thrown to the roadway below the bridge (must be ADA compliant).
4. **Bridge Approach Railings**
Approach railings are required at the ends of bridge railings exposed to approach traffic. On divided highways, with separate one-way traffic structures, they need to be placed to the left and right of approach traffic.
 - a. On two-way roadbeds with clear width less than 60 feet across the structure, approach railings need to be placed on both ends of the structure.
 - b. When the clear width is 60 feet or more, approach railings need to be placed only to the right of approach traffic.
 - c. Several types of approach railings are available, including Metal Beam Guardrail, Bridge Approach Guardrail (Types I and II) and Safety-Shape Barriers. The type of approach railing selected should match the rail to be used on the bridge. When long runs of guardrail (such as embankment guardrail) precede the bridge, the guardrail should connect to the bridge railing to serve the approach railing function.
 - d. Approach railings need to be flared or attenuation devices provided at their exposed end. (For detailed information refer to the AASHTO publication, Roadside Design Guide.)
 - e. Approach railing end treatments that use energy absorbing terminals should be flared by 2 feet for design speeds of 45 mph or above

RETAINING WALLS

5-3.302

A. Types and Uses

Recommended types of retaining walls include reinforced concrete and structural masonry. Heavy timber construction is not encouraged except when approved by the Transportation Department. The walls need to include integral attachments for railings and weep drainage where applicable.

B. Aesthetic Considerations

In general, the materials and design of retaining walls need to match or blend with the adjacent natural features, landscaping and/or buildings. The surface of the retaining wall should have a low light reflectance. Suggested surface treatments include exposed aggregate, stucco or mortar wash and native stone, or other surfaces as approved by the DRB.

The height of retaining walls within city rights-of-way cannot exceed 6 feet except when approved by the Transportation Department. If approved to retain above 6 feet, terracing is encouraged and the length of the alignment of the retaining walls should be foreshortened by vertical grooves, periodic offsets and height changes,

or other configurations as approved by the DRB. For more information refer to Chapter 2.

C. Safety Railings

A safety railing is required on or adjacent to vertical faces such as retaining walls, wing-walls and abutments, etc., and where the vertical fall is 30 inches or more. The safety railing needs to be constructed per city standard details and placed on top of the vertical face structure of the vertical drop. Guidelines for determining when safety railing should be installed are outlined in Appendix 5-3C.

STRUCTURAL CLEARANCES

5-3.303

A. Horizontal Clearance

1. Clear roadside design is recommended for all arterials and collectors whenever practical. Where the roadway is curbed, the clearance between curb face to edge of the object should be a minimum of 1.5 feet. A clearance of 3 feet should be provided near the turning radii at intersections and driveways to provide clearance for the overhang of trucks. For further guidance, refer to the AASHTO Roadside Design Guide.
2. The horizontal clearance to bridge piers, abutments, headwalls and retaining walls on all streets shall meet requirements of AASHTO Roadside Design Guide, can be no less than 10 feet from the edge of the traveled way and may require protection depending on the roadway design speed.
3. Drainage structures (pipes, box culverts, etc.) are to be extended to 10 feet from the edge of the travel way. A reduced clearance may only be allowed when rights-of-way limitations make the desired clearance unreasonable and appropriate traffic barriers are installed in accordance with the AASHTO Roadside Design Guide.

B. Vertical Clearance

Minimum vertical clearance shall be 16.5 feet over the entire width of the traveled way of an arterial street or major collector street. On other streets, the minimum shall be 14.5 feet. The Transportation Department must approve exceptions.

PARTIAL STREET IMPROVEMENTS

5-3.400

A full street cross-section is required for the interior streets of a development; typically, "half-street" improvements are required for unimproved perimeter streets. The required street cross section for half-street improvements will be determined by the Transportation Department based upon such factors as available right-of-way, existing street improvements, the need for auxiliary lanes, and proportionality to the development intensity/traffic generation. The half-street improvements will always include curb, gutter, and sidewalk along the site frontage unless it is determined that it is not feasible to be constructed in the ultimate location.

CONSTRUCTION OF HALF-STREETS

5-3.500

A. Design of Cross-Section for Half-Streets

Half-street construction consists of a minimum 24-foot-wide pavement section for major streets (major collector classification or higher) and a 20-foot-wide

pavement section for minor streets (minor collector classification or lower). For half-street construction, the engineer needs to design the full cross-section of the street. The plans need to include, in dashed lines, the half-street, which will be constructed in the future. The half street construction needs to provide adequate transitions and tapers to the adjoining roadways.

B. Joining Existing Street Pavement

The half-street must be designed to match existing construction as much as possible unless doing so is likely to create an unsatisfactory condition. If changes are needed to correct conditions on an existing half-street to properly construct the other half of the street, the solutions must be developed with Transportation Department staff on a case-by-case basis. The plans for the new half-street must contain sufficient information on the profile and cross-sections of the existing street to demonstrate that the new construction will match the old construction and result in a full street with proper cross-sections.

C. Culverts Under Half-Streets

A culvert to be provided in conjunction with half-street construction must extend a minimum of 10 feet beyond the edge of the traveled way into the area where the other half of the street will be constructed in the future (subject to rights-of-way availability). The 10-foot distance is measured perpendicular to the street alignment. The culvert capacity, flow line slope and alignment must be based upon the ultimate design requirements for the culvert if it were to be built under the full cross-section where it could be considerably longer. The culvert ends shall be protected in accordance with the AASHTO Roadside Design Guide. Temporary installation of culvert safety end section may be considered for an interim condition.

PAVEMENT TRANSITIONS

5-3.600

When development causes the widening of a portion of the pavement of an existing road, pavement transitions are required at each end of the widened portion. Design of the various features of the transition between pavements of different widths should be consistent with the design standards of the superior facility. The transitions should be made on a tangent section whenever possible. Locations with horizontal and vertical sight distance restrictions should be avoided. Whenever feasible, the entire transition should be visible to the driver of a vehicle approaching the narrower section. Intersections at grade within the transition area should be avoided.

A. Transition to a Wider Pavement Section

A transition from a narrower cross-section to a wider cross-section should be a length that is 5 times the street design speed in miles per hour. Refer to Figure 5-3.45.

B. Transition to a Narrower Pavement Section

For streets with speeds greater than 45 mph, a transition from a wider cross-section to a narrower cross-section needs to be a length equal to the difference of the two widths in feet times the street design speed in miles per hour, or the 85th percentile speed in miles per hour, whichever is greater. For streets with speed equal to or less than 45 mph, the transition should be equal to the difference of the two widths,

times the square of the design speed divided by 60. Figure 5-3.45 illustrates this requirement.

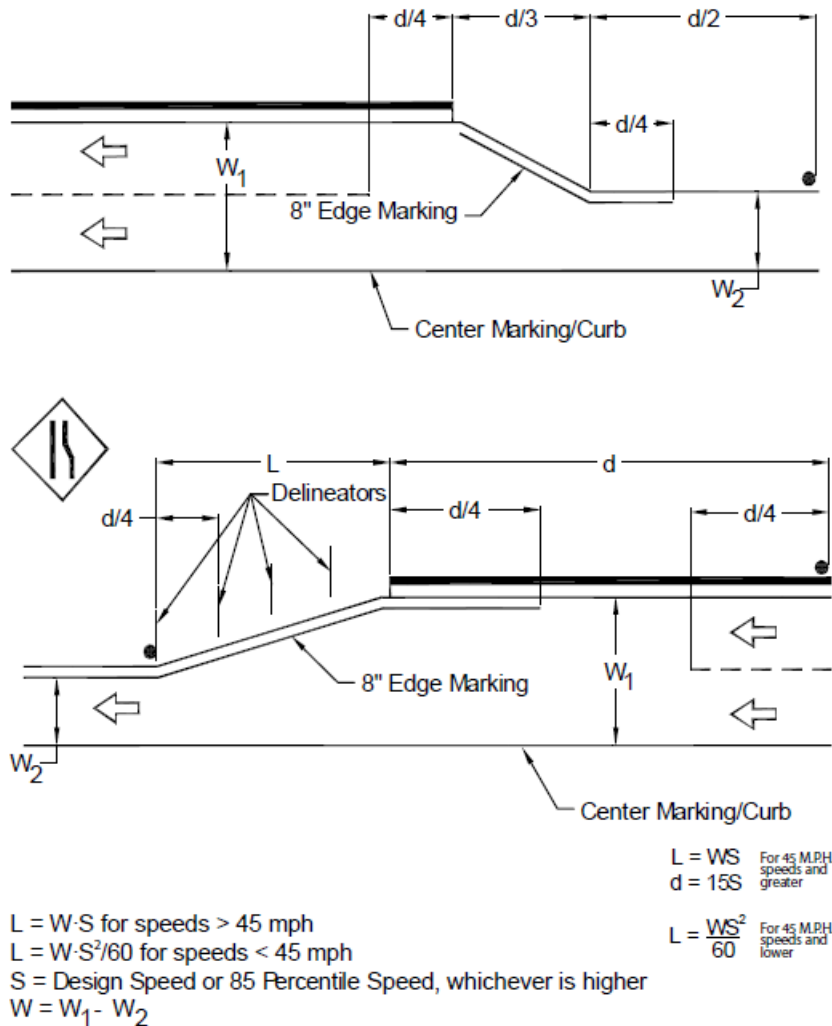

FIGURE 5-3.42 PAVEMENT WIDTH TRANSITIONS

FRONTAGE ROADS

5-3.700

Generally, there are two types of frontage roads, those along freeways that provide commercial access and those along arterials that provide residential access. The city does not typically have jurisdiction over freeway frontage roads.

A. Freeway Frontage Road Access

Any proposed freeway frontage roads, or access to existing or planned frontage roads, should be coordinated with the city's Transportation Department and ADOT. The city must be consulted to ensure the frontage road, or access to such, does not have a detrimental impact on the adjacent city street system.

B. City Street Frontage Roads

New frontage roads for residential access are not encouraged and must be approved by the Transportation Department. Frontage road geometrics are to be based upon specific project requirements, but generally should not be less than 20 feet in width. Connections to the intersecting side street need to be out of the intersection influence area as outlined in the Access Management Manual.

SUBDIVISION STREET PLANNING

5-3.800

Subdivision street plans should produce the minimum number of intersections and wash crossings and discourage through traffic. Pedestrian connections should be provided even where streets do not connect, such as from cul-de-sacs to adjacent streets, to minimize the walking distance to nearby parks, schools, commercial centers, etc. Figure 5-3.46 illustrates many concepts associated with desired subdivision street design. The following paragraphs describe certain other concepts and requirements.

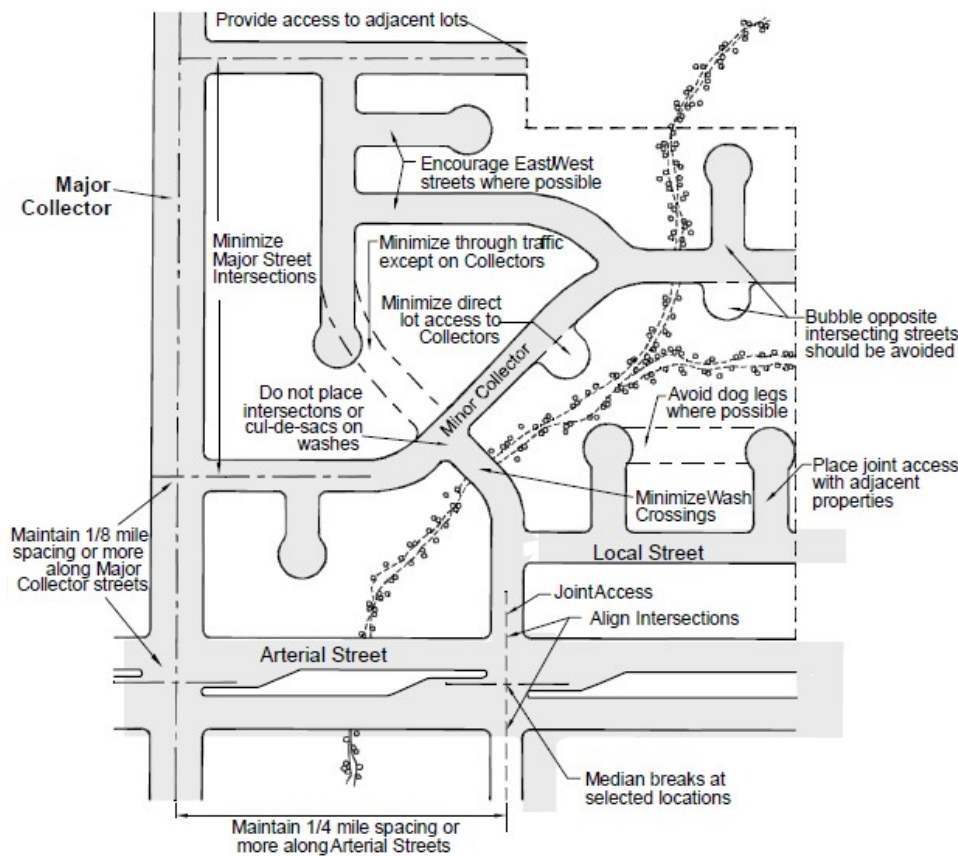

FIGURE 5-3.43 SUBDIVISION STREET PLANNING

A. Existing and Proposed Streets

Existing streets and proposed streets of the Mobility Element of the General Plan, the Streets Master Plan, or any applicable Master Circulation Plan or Area Plan should be incorporated into the design of new subdivisions. Exceptions must be approved by the Transportation Department and may require the approval of the Transportation Commission.

B. Street Abandonment

An existing public street may be abandoned if it is not a street indicated in the Street Classification Map or an Area Plan, and if it will not eliminate reasonable access to existing adjacent properties. The abandonment should alleviate a significant traffic problem and not create a new problem. If a street abandonment is approved, the abandonment must occur prior to submitting a final plat to the City Council.

C. Cul-de-Sac Street Lengths

A cul-de-sac street is a street that serves more than one property owner and has only one direct access to the public street system. The following requirements apply to both public and private streets. The length of a cul-de-sac is measured between the centerline of an intersecting street and the radius point of the cul-de-sac, as shown below in Figure 5-3.47; the minimum length of a cul-de-sac is two times radius R1, as illustrated. A cul-de-sac street cannot be longer than 1,500 feet and it cannot serve more than 25 single-family dwelling units; in situations where these conditions cannot be met, a secondary access may be required, or the street may need to be upgraded to a collector level classification.

Classification of Cul-de-sac	Bubble Radii (ft.)	
	R1 (B.C.)	R2 (P.L.)
Local Residential	40.5	50
Local Commercial/Multi-family	60.5	70
Local Industrial	60.5	70

- Minimum Length = 2R
- Maximum Length = 1500 ft.
- ADT = 250 vpd maximum
- Maximum number of units served = 25
- Cul-de-sac radii are the same for private streets

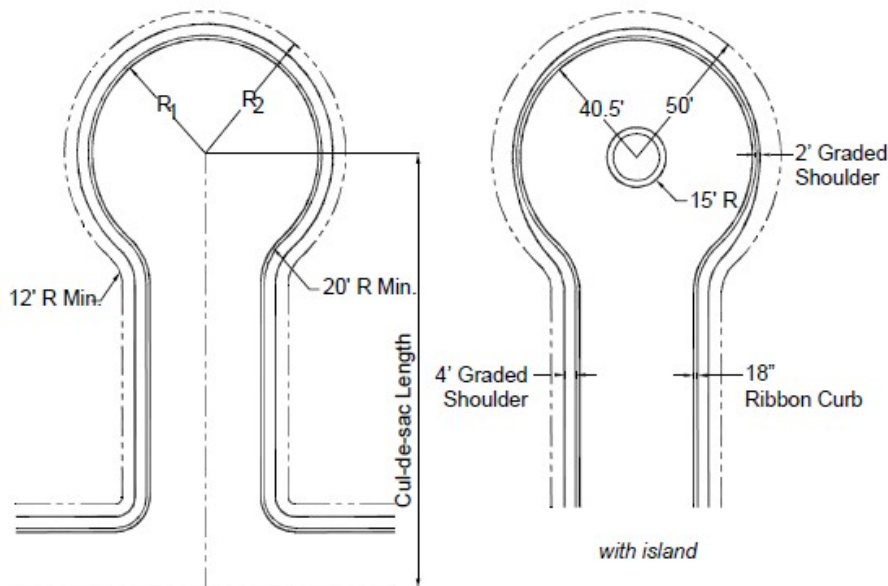

FIGURE 5-3.44 CUL-DE-SAC STREET LENGTH

D. Dead-End Streets

Dead-end streets are required where a street connection is necessary to serve adjacent properties that will develop at a future date. When a dead-end street is created, a temporary cul-de-sac needs to be provided. A dead-end street should not exceed 300 feet in length without an approved turn-around.

E. Bubbles

Bubbles are areas on the roadway expanded to provide a turn-around and additional access or lot frontage on minor collector and local streets. Bubbles are required at intersections where each street extends in only one direction from the intersection. Bubbles are permitted between intersections to improve accessibility to odd-shaped sites, or on minor collector streets where direct access is not permitted. The bubble radii for local streets are shown on Figure 5-3.49. Radii for cul-de-sac bubbles for other street classifications are shown below in Figure 5-3.48. The use of bubbles (except for on a cul-de-sac) on other than local residential streets must be approved by the Transportation Department. Radii appropriate for these bubbles will be established as part of that approval.

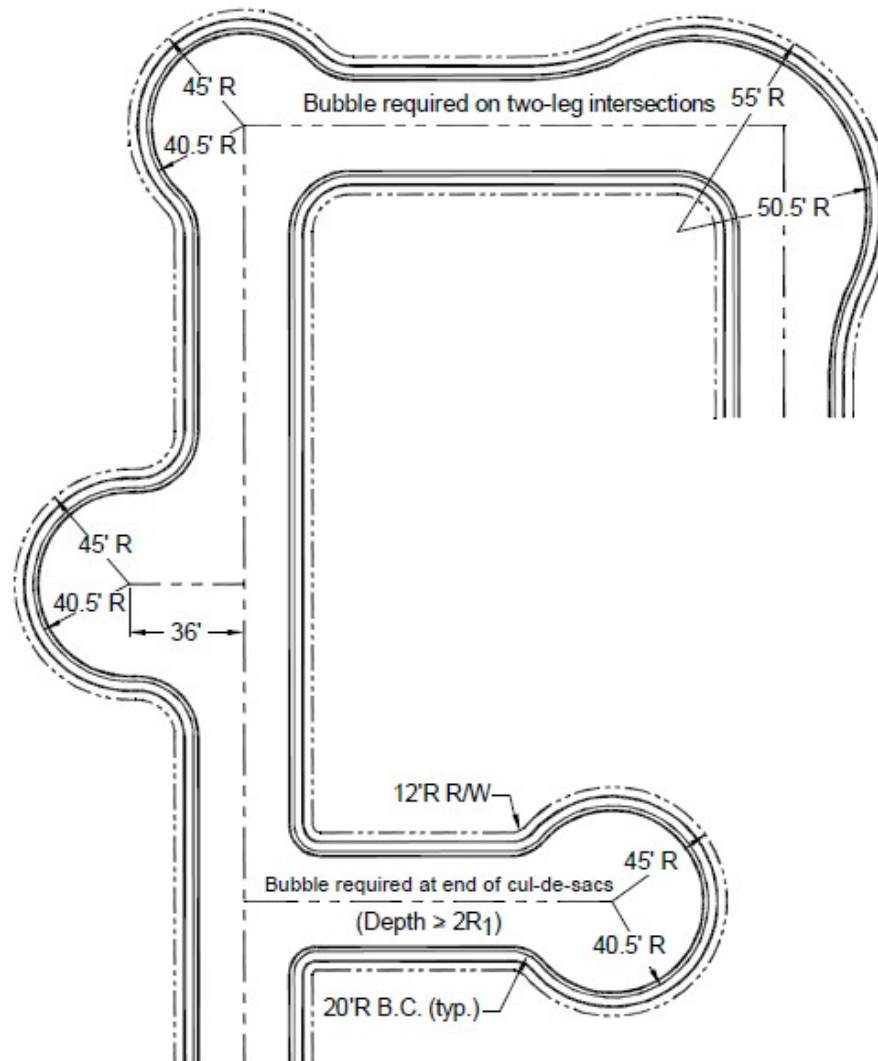

FIGURE 5-3.45 BUBBLES FOR STREETS

The bubble radii shown on this Figure 5-3.45 are for local streets. The use of bubbles (except for a cul-de-sac) on other than local residential streets must be approved by the Transportation Department. Radii appropriate for these bubbles will be established as part of that approval.

F. Alleys

Alleys are discouraged and are subject to Transportation Department approval; however, alleys may be required where other alleys exist or where the extension of an existing alley or alley system is necessary. Dead-end alleys will not be permitted.

1. Alley Widths

Residential alleys abutting single-family uses need to be 16 feet in width. For other abutting uses, the alley provision is 20 feet in width.

2. Alley Intersections

Alley intersections and sharp changes in alignment should be avoided. When intersections or alignment changes are allowed, the inside corners need to be

cut off on each side to provide a tangent section between the two sides at least 20 feet long, as shown in Figure 5-3.49 below.

3. Alley Paving

All alleys are to be fully paved with at least 2.5 inches of asphaltic concrete over 6 inches of ABC.

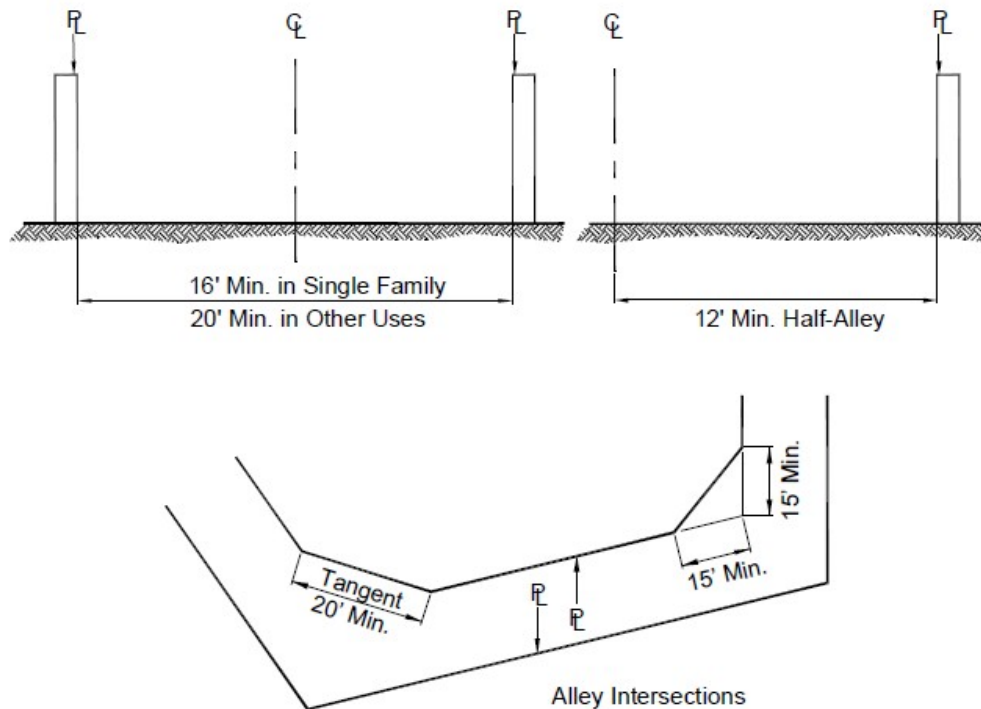

FIGURE 5-3.46 ALLEY WIDTHS AND INTERSECTIONS

G. Offset Intersections

Street jogs with centerline offsets less than 250 feet are not permitted along arterial and major collector streets, or on minor collector and local commercial and industrial streets where interlocking left turns will occur. Offsets as small as 125 feet are allowed on local residential streets and minor collector and local commercial and industrial streets where interlocking left turns will not occur.

H. Intersecting Tangents

A tangent section of roadway is desirable prior to an intersection on a curvilinear street. Minor street intersections with major streets need to have a minimum tangent outside the intersecting rights-of-way. Refer to Appendix 5-3A for design criteria.

SPECIAL STANDARDS

A development may desire a special set of standards that differs from the city standards contained in this document. This request is typically made for master planned communities as part of their associated master circulation plan. In such a case, a qualified traffic engineer, registered in the State of Arizona, must prepare a preliminary and final traffic design report and secure city approval of the reports

5-3.900

before plans incorporating the special standards can be submitted for review and approval.

A. Preliminary Traffic Design Report

A preliminary design report needs to be submitted prior to or at the time of preliminary plat submittal refer to Chapter 5-1 for specific information. At a minimum, the preliminary report must address the following subjects:

1. Vehicle Trip Generation
2. Traffic Control Device Requirements
3. Pedestrian, Bicycle and Equestrian Requirements
4. Auxiliary Additional Lane Requirements
5. Special Features and Their Influences
6. ADA Access
7. Design Speeds
8. Roadway Classifications
9. Parking Requirements
10. Transit Facility Requirements
11. Intersection Sight Distance Evaluation
12. Expected Safety Performance

Where possible the Preliminary Traffic Design Report should include a discussion of the elements required in the Final Traffic Design Report so that the city may comment and suggest changes prior to submission of the Final Design Report.

B. Final Traffic Design Report

A final design report needs to be submitted prior to or concurrently with the improvement plan submittal. The report must include a refinement of the preliminary design report and address the following subjects as a minimum:

1. Horizontal and Vertical Alignment
2. Intersection Location
3. Traffic Control Devices
4. Treatment of Special Features

C. City Review and Approval of Special Standards

The following factors will be considered by the city in its review of the report:

1. Relationship of the proposed standards to national, state and city standards
2. Similarity of the proposed standards to standards utilized in other communities
3. Comparison of the proposed standards with alternatives
4. Sensitivity of the proposed standards to safety, environmental and law enforcement concerns

ESL STANDARDS

5-3.1000

Streets that are constructed within the ESL area should be designed to minimize the impact on the adjacent topography and landscape. The following standards have been developed specifically for streets that are constructed within the ESL areas and vary from design standards for the non-ESL area streets that are contained in the previous sections of this document. Additional information is contained in Section 2-2. Environmentally Sensitive Lands; Figure 2-2.1 depicts the areas within the city where these criteria apply.

A. Design Vehicle

For ESL areas, the basic design vehicle for all non-arterial streets is the Single Unit Truck as defined by AASHTO.

B. Horizontal Curves

Tangent sections between horizontal curves (compound or reverse) are not required for local residential streets in the ESL areas.

C. Street Grades

Longitudinal street grades within the ESL areas may range from 0.4 percent to 12 percent. In general, the maximum street grade should be 5 percent for major collectors, 10 percent for minor collectors and 12 percent for local residential streets. In areas with steep slopes and no alternative access provisions, steeper grades may be approved as shown in Figure 5-3.50. Lengths of flatter grades should be incorporated on steeper grades to provide a recovery area for emergency and service vehicles. Steeper grades may be approved in areas where it can be shown they would be less disruptive to the surrounding area and emergency and service vehicle access can be maintained. The city will not approve exceptions for any federally-funded projects.

Street Classification	Maximum Grade
Major Collector	9 percent
Minor Collector	12 percent
Local Collector	12 percent
Local Residential	15 percent
Gradient	Maximum Grade Length
7 – 9 percent	1400 ft
9 – 12 percent	700 ft
12 - 15 percent	12 percent
Local Residential	15 percent

FIGURE 5-3.47 STREET GRADES AND LENGTHS

D. Cross Slope

Cross slope should not exceed 4 percent. In ESL areas it may be necessary to use roadway cross slope to control drainage. Shoulder slopes should match the pavement cross slope.

E. Street Intersections

Right-angle intersections, those that intersect at an angle of 90 degrees, are the most desirable. They provide the shortest crossing distance and the best driver sight distance. Intersection angles that diverge by five degrees or more from 90 degrees are not allowed on minor collector or higher classified streets without approval from the Transportation Department. Local streets may have an angle divergence up to 15 percent at street intersections. If an intersection occurs along a curve, the side street centerline must be radial (no divergence) to the curve of the through street.

The minimum intersection spacing along local collector and local residential streets should be a minimum distance of 165 feet.

ROADWAY DESIGN CRITERIA

STREET DESIGN ELEMENT	DESIGN SPEED (MPH)						
	55	50	45	40	35	30	25
Minimum horizontal curve radius without superelevation, ft ¹	1837	1392	1039	762	510	333	198
Minimum horizontal curve radius with 2% superelevation, ft ²	1347	1044	764	593	408	273	167
Minimum horizontal curve length, ft	500	500	500	450	400	250	100
Minimum tangent length between reverse curves, ft	300	300	250	200	200	150	100
Minimum tangent length between curves in same direction, ft	660	660	500	450	400	250	100
Minimum tangent approaching intersection, ft	300	300	250	200	200	150	100
Minimum stopping sight distance (< 3% grade), ft ³	495	425	360	305	250	200	155
Maximum rate of vertical curve, K	114	84	61	44	29	19	12

Intersection sight distance

Refer to Appendix 5-3B

1. Minimum radii values from AASHTO A Policy on Geometric Design of Highways and Streets (Green Book), 6th Edition, 2011, Table 3-13b for a 2% cross slope or -2% superelevation. Values for 50 and 55 mph calculated using Equation 3-8.
2. Minimum radii values from Table 3-13b in AASHTO Green Book, Table 3-13b for a 2% superelevation. Values for 50 and 55 mph calculated using Equation 3-8.
3. Stopping Sight Distance from AASHTO A Policy on Geometric Design of Highways and Streets (Green Book), 6th Edition, 201; Table 3-2 for stopping sign distance requirements on grades >3%.

SITE DISTANCE

SIX LANE ROADWAY¹

SIGHT DISTANCE						
DESIGN SPEED	PASSENGER CAR		SINGLE-UNIT TRUCK		COMBINATION TRUCK	
	TH	LT	TH	LT	TH	LT
25	304	340	403	440	476	513
30	364	408	483	527	572	616
35	425	476	564	615	667	718
40	486	544	644	703	762	821
45	546	612	725	791	857	923
50	607	680	805	879	952	1026
55	668	748	886	967	1048	1128

FOUR LANE ROADWAY¹

SIGHT DISTANCE						
DESIGN SPEED	PASSENGER CAR		SINGLE-UNIT TRUCK		COMBINATION TRUCK	
	TH	LT	TH	LT	TH	LT
25	285	322	377	414	451	487
30	342	386	453	497	541	585
35	399	451	528	579	631	682
40	456	515	603	662	721	780
45	513	579	679	745	811	877
50	570	644	754	827	901	974
55	627	708	829	910	991	1072

THREE LANE ROADWAY¹

SIGHT DISTANCE						
DESIGN SPEED	PASSENGER CAR		SINGLE-UNIT TRUCK		COMBINATION TRUCK	
	TH	LT	TH	LT	TH	LT
25	267	304	351	388	425	462
30	320	364	422	466	510	554
35	374	425	492	543	595	646
40	427	486	562	621	680	738
45	480	546	632	698	765	831
50	267	304	351	388	425	462
55	320	364	422	466	510	554

SITE DISTANCE

TWO LANE ROADWAY¹

SIGHT DISTANCE						
DESIGN SPEED	PASSENGER CAR		SINGLE-UNIT TRUCK		COMBINATION TRUCK	
	TH	LT	TH	LT	TH	LT
25	239	276	313	350	386	423
30	287	331	375	419	464	508
35	335	386	438	489	541	592
40	383	441	500	559	618	677
45	430	497	563	629	695	761
50	478	552	625	699	772	846
55	526	607	688	769	849	930

Notes: ¹

Cross section assumed to include a 12' median/center lane and 6' bike lane

TH = Through Movement, LT = Turn Movement

All distances given in feet

Design speed by roadway classification is shown in Appendix 5-3A

For cross sections deviating from the tabulated configurations, refer to the AASHTO Geometric Design of Highways and Streets (current editions) for additional information

SAFETY RAIL

When a pedestrian facility is adjacent to a steep downwards slope, a body of water, or other potential obstacles consideration should be given towards some form of mitigation. As reference, the IBC uses 30-inch drop and 30 inches of separation to help determine the need for mitigation in the built environment. The following table is provided as a general guideline in the less built environment outside of areas covered by the IBC such as right of way:

SAFETY RAIL GUIDELINE

Distance to Pedestrian Facility (ft)	Total Drop (ft)	Slope	Action
10+	& ≤ 1	& N/A	then None
10+	& 1 to 2.5	& >1/1	then None
10+	& 2.5 to 4	& >1/1	then None
10+	& 4 to 6	& >2/1	then None
10+	& >6	& >3/1	then Consider
5 to 10	& ≤ 1	& N/A	then None
5 to 10	& 1 to 2.5	& >1/1	then None
5 to 10	& 2.5 to 4	& >1/1	then None
5 to 10	& 4 to 6	& >2/1	then Consider
5 to 10	& >6	& >3/1	then Consider
2 to 5	& ≤ 1	& N/A	then None
2 to 5	& 1 to 2.5	& >1/1	then None
2 to 5	& 2.5 to 4	& >1/1	then Consider
2 to 5	& 4 to 6	& >2/1	then Recommended
2 to 5	& >6	& >3/1	then Recommended
< 2	& ≤ 1	& N/A	then None
Less than 2	& 1 to 2.5	& >1/1	then Consider
Less than 2	& 2.5 to 4	& >1/1	then Recommended
Less than 2	& 4 to 6	& >2/1	then Recommended
Less than 2	& >6	& >3/1	then Recommended

Notes:

Pedestrian facility refers to any sidewalk, path, trail, etc.

Distance to pedestrian facility is to be measured from the edge of the facility

Total drop is the difference in elevation (in feet) between the top and bottom of a slope adjacent to a pedestrian facility

SAFETY RAIL

A. Considerations

1. The proximity of the potential obstacle to the pedestrian facility is of utmost importance (typically) when determining if mitigation is required. The closer a potential obstacle is to the pedestrians expected travel path, the greater the consideration given towards mitigation.
2. Furthermore, the potential severity of encountering an obstacle should also be considered. The material/type of potential obstacle adjacent to the pedestrian facility must be analyzed. For instance, a rough angular rip-rap embankment next to a sidewalk would be given more consideration than a grass or lightly vegetated embankment.
3. In general, a higher severity is assigned to a potential obstacle if it is considered non-traversable or if encountering the obstacle could lead to severe injury. Likewise, a lower severity is assigned if the potential obstacle is considered traversable or if encountering the obstacle is unlikely to lead to injury. The table below outlines the potential severity of a few potential obstacles; however, engineering judgment should be applied on a case by case basis.

SEVERITY	SEVERITY OF HAZARDS		
	High	Medium	Low
POTENTIAL OBSTACLES	Body of water	Dense vegetation	Sand
	Rip-rap	Slippery surfaces	Native Soils
	Boulders		Grass
	Large rocks		Sparse vegetation

B. Alignment

1. The vertical alignment of a pedestrian facility could lead to mitigation being required. For example, consideration should be given to mitigation in cases where the vertical alignment a facility negatively impacts the visibility leading up to an obstacle or where a downhill grade would lead to increased speeds leading up to an obstacle.
2. The horizontal alignment of a pedestrian facility also needs to be considered, especially when sharp curves exist along the facility. For example, if a curve exists within a pedestrian facility, and remaining on the alignment throughout the curve would lead to an encounter with an obstacle, consideration should be given to mitigation. See Figure 5-3C1 below; while the bottom of the slope at point B is closer to the facility than point A, point A presents a greater potential threat due to the horizontal alignment.

SAFETY RAIL

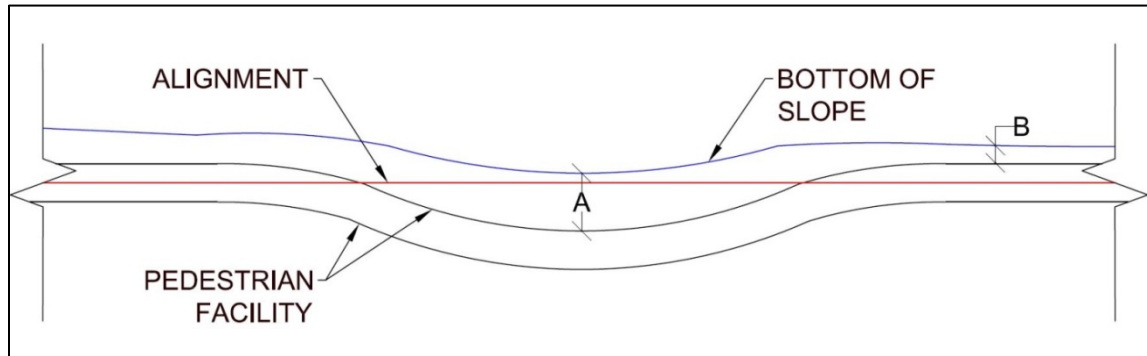

FIGURE 5-3C1: HORIZONTAL CURVE IN PEDESTRIAN FACILITY

C. Types of Treatments

1. If some form of action is deemed necessary, then one of the three following alternatives can be considered:
 - a. **Remove obstacle**- may not always be feasible due to extent of removals required and/or associated costs
 - b. **Add safety rail** – It should be noted that the installation of a safety rail in of itself is a potential obstacle for both pedestrians and vehicles. A safety rail should only be selected when it is determined that the installation of the rail would decrease the potential severity for some users and not significantly increase the potential severity to other users.
 - c. **Signage and markings** – Striping, object markers, and signage can be used to highlight a potential obstacle to nearby pedestrians, thus increasing their awareness.
2. Engineering judgment should be applied when selecting the type of treatment and should consider the potential severity of encountering the obstacle, the likelihood of encountering the obstacle, the horizontal alignment of the pedestrian facility, and associated costs of mitigation.

Section 5-4

TRAFFIC SIGNAL DESIGN

5-4

This section presents the process and criteria for preparing traffic signal plans for the city. It identifies traffic signal design criteria, plan content, and equipment requirements and specifications.

GENERAL INFORMATION

5-4.000

A. Scottsdale Traffic Signal Policies

The following policies have been adopted by the City Council. Requests to deviate from these policies must be submitted in writing to the STED for consideration.

1. Install warranted traffic signals to maintain 1/2-mile signal spacing on expressways, parkways and major and minor arterials. Spacing must be consistent with the city's traffic control system plan.
2. Install warranted traffic signals to maintain 1/4 mile spacing on major collectors. Spacing must be consistent with the city's traffic control system plan.
3. Install warranted left-turn arrows based upon established City of Scottsdale criteria.
4. Require a complete traffic signal plan when a new traffic signal is to be constructed, or when an existing signal or any part of an existing signal is to be modified in any way.
5. Require any traffic signal construction, private or public, to be supervised on-site by a certified International Municipal Signal Association (IMSA) Level II Signal Technician.

B. Reference Documents

The current version of the following publications, adopted by ADOT, is to be used in conjunction with the design criteria in this document.

1. Manual on Uniform Traffic Control Devices for Streets and Highways (MUTCD) - USDOT, FHWA
2. Standard Specifications for Road and Bridge Construction and General Specifications for Traffic Signals and Highway Lighting - Construction Specifications, ADOT
3. Traffic Signals and Lighting and Signing and Marking - Standard Drawings, ADOT
4. Equipment and Materials Standards for Light-Emitting Diode (LED) Signal Modules, ITE
5. Traffic Control Design Guidelines - ADOT
6. Manual of Signs Approved for Use on State Highway System - ADOT
7. Traffic Engineering Policies, Guide and Procedure Manual - ADOT
8. Informational Guide for Roadway Lighting - AASHTO
9. Guide to Standardized Highway Lighting Pole Hardware - AASHTO
10. Uniform Standard Specifications for Public Works Construction - MAG
11. Uniform Standard Details for Public Works Construction - MAG
12. COS Supplement to MAG Uniform Standard Specifications for Public Works Construction
13. COS Supplement to MAG Uniform Standard Details for Public Works Construction
14. COS Traffic Signal Special Requirements

C. Other References

United States Access Board Proposed Guidelines for Pedestrian Facilities in the Public Right-of-Way ([PROWAG](#)), July 26, 2011.

D. Pre-Design Conference with Traffic Engineering Division

Prior to beginning traffic signal design, a pre-design conference may be requested by either Traffic Engineering or the design consultant.

E. Pre-Construction Conference with Traffic Signal Division

Prior to start of work, the contractor must contact City of Scottsdale Traffic Signals at 480-312-7777 to arrange a pre-construction conference.

DESIGN CRITERIA

5-4.100

All equipment and materials specified must be listed on the COS Qualified Products List (QPL) as shown in Appendix 5-4B. For items listed on the QPL, material submittals must be provided to Traffic Signals Division at least 30 working days prior to signal construction.

For items not on the Scottsdale QPL, material submittals must be received for review and/or approval to Traffic Signals Division, 60 working days prior to signal construction. For information call 480-312-5620.

New or modified traffic signals shall be provided with Ethernet connectivity to the Scottsdale Traffic Management Center (TMC) and central management system. Scottsdale Intelligent Transportation Systems (ITS) designs are not listed in these guidelines. However, reference to ITS special provisions, plans or details may be called out on the signal plans for coordination requirements. To obtain ITS details and special provisions, the applicant must submit a separate plan and special provisions document to the Scottsdale Traffic Management Center. For information call 480-312-7777.

PROVISIONS

5-4.101

The COS "Boiler Plate" construction specifications need to be used. Traffic Engineering and/or the designer will determine the need for project-specific construction special provisions. Notes may be added to the construction plans if the designer feels that it is necessary to deviate from these listed requirements.

SIGNAL STRUCTURES

5-4.102

- A. Poles and foundations need to adhere to ADOT's Traffic Signals and Lighting-Standard Drawings, ADOT Standard Specifications for Road and Bridge Construction and must meet the COS QPL.
- B. Pedestrian landings and level surfaces meeting the MUTCD and PROWAG design guidelines must be provided. Refer to Section 5-4.104 for details.
- C. Contact Traffic Signal Division to confirm specific pole/ structure styles and colors in designated development areas.
- D. Combination poles, bracket arms, mast arms, bases and foundation entrance conduit need to be included on the traffic signal plan.

SIGNALS

- A. All design elements must comply with the MUTCD standards unless directed otherwise by Traffic Engineering.
- B. Twelve-inch signal faces are required for all through indications and for all left-turn and right-turn indications. Eight-inch signal faces shall not be used. Refer to Figure 5-4.1.
- C. Typically, a minimum of 4 heads is required for control of a through movement (2 overhead mount and 2, side-mounts – left and right). Typically, a minimum of 2 heads is required for control of other movements. The overhead indications need to be centered on the lane lines to increase sight distance.
- D. Typically, a minimum of 2 heads is required to control a left-turn movement. One head shall be overhead-mounted on the mast arm containing the heads that control the corresponding through movement (or median mounted if the median width is greater than 6 feet) and the other head shall be side-mounted or pole-mounted on the far-side left corner facing the corresponding through movement.
- E. All indications shall be wide-angle LED lamps and meet ITE Equipment and Material Standards for LED traffic signal indications. All pedestrian indications shall also be LED lamps.
- F. Questions regarding indication type should be directed to COS Traffic Operations Division at 480-312-5620.
- G. Fiber optic signal indications shall not be used unless directed otherwise by Traffic Engineering.
- H. All traffic signals shall provide Ethernet communications to the city's central system, unless explicitly exempted by Traffic Operations Division.
- I. Signal heads shall be polycarbonate and painted 'flat' black.
- J. Mounting brackets shall be painted black semi-gloss.
- K. Back plates and tunnel visors shall be aluminum, painted 'flat' black, and installed on all signal faces.
- L. Base-mount mounting height of 4- and 5-section heads should be adjusted to avoid conflict with mast arm. The aiming of the head cannot conflict with the mast arm or mast arm connection. These side-mount heads should be mounted on the backside of the pole, at a 45-degree angle and at a height of 115 inches. See COS Standard Detail 2138.
- M. A maximum of 3 heads may be installed on a mast arm that is 40 feet in length or less. A maximum of 4 heads may be installed on a mast arm that is 45 feet to 50 feet long. A maximum of 5 heads may be installed on mast arms longer than 50 feet.
- N. The mast arm must include tenons to install the maximum allowed number of signal heads. All mast arms tenons shall be installed at 12-foot intervals, with the outboard (left) tenon at 14 feet from the first inboard tenon.
- O. Traffic Engineering must approve the use and placement of right-turn arrow heads. Right-turn heads shall be 4-section "G" heads.
- P. ADOT type XI mounting hardware will not be used in Scottsdale signal designs, refer to Figure 5-4.2.

- Q. 4-section "G" heads shall be used instead of 5-section "Q" heads for all locations where permitted/protected left turn phasing is designed, refer to Figure 5-4.1. All hardware shall be mounted on pole "backside at 45 degrees" or per COS Traffic Signal Division requirements.

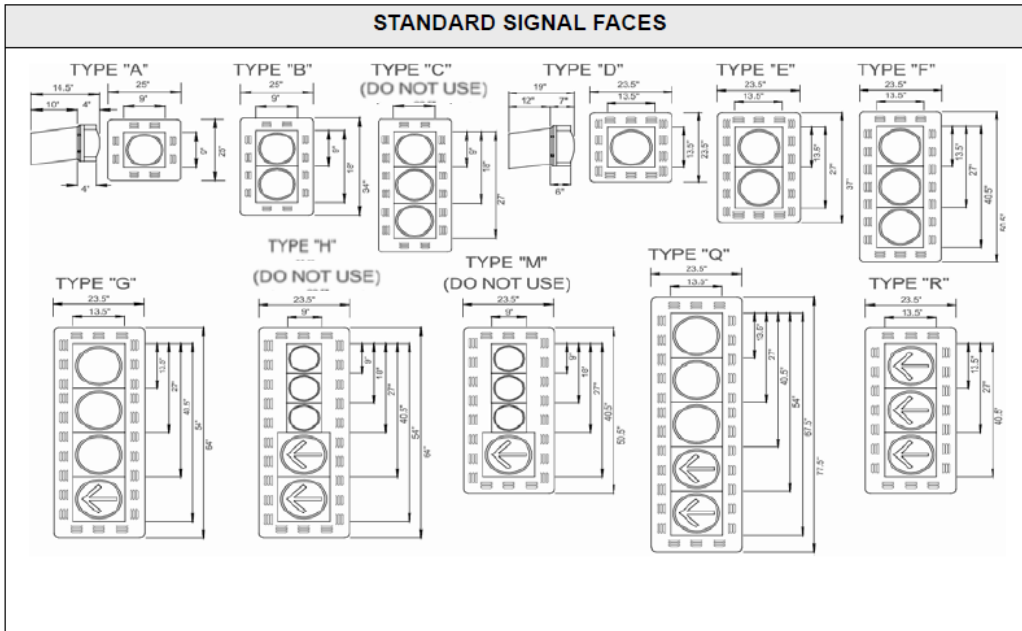

FIGURE 5-4.1 STANDARD SIGNAL FACES

MOUNTING ASSEMBLIES					
Type	Plan Symbol	Ref.	Type	Plan Symbol	Ref.
I		ADOT T.S. 9-1	VII		ADOT T.S. 9-5
II		ADOT T.S. 9-2	VIII		ADOT T.S. 9-6
III		ADOT T.S. 9-2	IX		ADOT T.S. 9-7
IV		ADOT T.S. 9-2	X		ADOT T.S. 9-8
V		ADOT T.S. 9-3	XI		ADOT T.S. 9-9
VI		ADOT T.S. 9-4	do not use		

FIGURE 5-4.2 MOUNTING ASSEMBLIES PLAN SYMBOLS

PEDESTRIAN SIGNALS

- A. Pedestrian signals should be installed at ALL intersections unless directed otherwise by the Traffic Engineering Division.
- B. Pedestrian pushbuttons should be installed for ALL crossing directions unless directed otherwise by the Traffic Engineering Division.
- C. Pedestrian signal facilities shall satisfy the most current MUTCD and PROWAG for ADA compliance.
 1. New or modified traffic signals will be provided with MUTCD compliant audible pedestrian signals for all crosswalks at the intersection. Refer to QPL for approved products.
 2. Provide compliant pedestrian ramps and a concrete level landing immediately adjacent to the pole and directly under the pedestrian signal button.
 3. The landing shall have no more than 1.5 percent slope in any direction. Minimum dimension of the landing will be 30" by 48".
 4. Pushbutton posts, if used, will conform to ADOT Detail T.S. 4-22, except that the pedestrian signal button shall be mounted at 42 inches to center of button from finished level landing elevation.
- D. Pedestrian signals must be 16-inch LED "Man/Hand with Countdown" indication and have bottom hinges.
- E. The pedestrian push button sign, R10-3b (R or L), 9" x 12", needs to be included in the design. Contact Traffic Operations Division at 480-312-5620 for details.

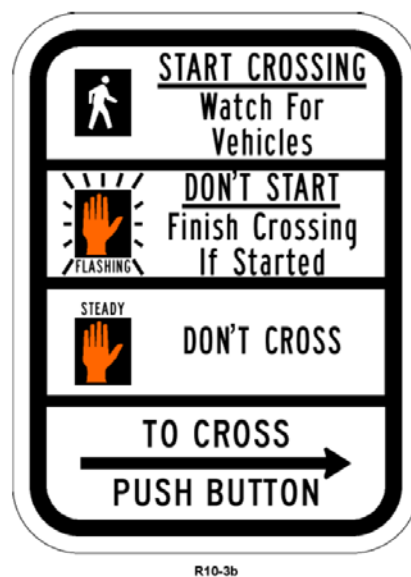

FIGURE 5-4.3 PEDESTRIAN PUSH BUTTON SIGN

CONTROLLER

The Controller shall be an Econolite Cobalt Rack Mount unless otherwise directed by the Traffic Operations Division. The controller shall be new, of latest release. No used or refurbished units will be allowed.

CONTROLLER CABINET

The controller cabinet must be Safetran model 332 hybrid traffic/ ITS cabinet with extender base and access panel, unless otherwise directed by the Traffic Operations Division. Traffic Operations Division must review and approve all cabinets prior to installation.

Typically, the cabinet shall be located on the same corner as the power cabinet, usually on the corner nearest to the power source as specified by the power provider. To the extent possible, the cabinet should be shielded and protected from the threat of errant vehicles and outside the desired driver sight lines to oncoming traffic. The cabinet should be positioned to allow a technician working within the cabinet to face the intersection under control with a clear view of the intersection operation.

The cabinet foundation dimensions need to be 36-inch x 36-inch, project 6 to 8 inches above the adjacent (ultimate) ground elevation and extend 32 to 36 inches below the adjacent (ultimate) ground elevation. Refer to COS Standard Detail 2139 for Traffic Signal Controller Cabinet Base Extender. The Tech Pad needs to be installed in front of the cabinet with the dimensions of 36-inch x 36-inch x 4 inch. Installation of an 8 feet x 5/8-inch copper ground rod shall be installed in the cabinet using 1-inch polyvinyl chloride pipe (PVC) conduit.

A. Electric Service Cabinet

1. The electric service cabinet shall be MEYERS model MEUG16-M125 or approved equivalent unless otherwise directed by the Traffic Engineering Division. The electric service cabinet must include the following: lightning arrest (2 ground rods, min. 5 ft separation), photocell receptacle rated for 20 amperages or more, sub-breakers and test/auto switch, painted per city cabinet specs. Photocell shall be oriented in the North direction.
2. Designer is responsible to contact the utility company for power run design. Install a #7 pull box adjacent to the electric service cabinet. Also, install a power run from the pull box to the cabinet. Power run design shall be per utility company requirements.
3. When the power source is an overhead power drop, use a 2-inch galvanized conduit above ground and through the first underground sweep. Power run design shall be per utility company requirements.
4. The cabinet foundation should have dimensions of 30-inch x 30 inch and project 6 to 8 inches above the adjacent (ultimate) ground elevation. Extend the cabinet foundation 32 to 36 inches below the adjacent (ultimate) ground elevation. Install a tech pad in front of the cabinet with dimensions of 30 inches x 36 inches x 4 inches. Locate the service cabinet no closer than 10 feet from the traffic signal control cabinet (edge-to-edge).
5. Mount a permanently affixed metal address tag on the front side of the electrical service cabinet with 1-inch lettering that faces the road, and a second tag with 2-inch lettering on the side.

B. Vehicle Detection

1. Video vehicle detection will be provided for all new and existing approaches at all new or modified traffic signal installations. Refer to the QPL for approved products.

2. Contractor is responsible for placement of all detection and detection equipment. Layout shall be inspected by COS Traffic Signal Inspector prior to implementation.
3. Prior to city acceptance, the contractor must inspect and test the vehicle detection, in the presence of the COS Traffic Signal Inspector.

C. Conductors

1. IMSA 19-1 stranded cable shall be used for all signal and pedestrian conductors. Two 20-conductor cables shall be installed in all street crossings and in the cabinet home run. Dedicated cables will be provided from the nearest pullbox to the signal heads as indicated:
 - a. Install 7-conductor cables on the outboard mast arm mounted vehicle head and all side mount vehicle heads.
 - b. Install 4-conductor cables to each remaining vehicle head and pedestrian signal head, and each pushbutton.
2. Signal conductor grounding wire shall be #8 green stranded for all runs.
3. Preemption detector cable per QPL, or approved equivalent, shall be used with preemption detectors. Do not splice preemption detector cable between pole connection and cabinet termination.
4. In any disturbed existing conduit run, remove old wire and re-pull completely with new wire. Use of wire pulling lubricant is required in all conduits. Install detectable pull strap (min. 2500 lb. strength) in every conduit run.
5. Do not splice wires except in pull boxes. Twist wire splices prior to installing silicone-filled wire nuts per approved product on QPL.
6. All conductors shall run continuous from the signal indication to the pull box. Do not splice conductors and do not loop conductors through the side mount termination block.
7. Where cables loop through pullboxes, they shall be marked with tape to designate cable 1 (one tape wrap) or cable 2 (2 tape wraps), colored per direction or appropriate phasing tape for other conductors. Refer to Figures 5.4-6 thru -8.
8. Conductors and cables have a minimum of 36 inches of slack in all pullboxes.
9. All future conduits and mast arm tenons shall have a detectable pull strap installed and be capped with a 2-inch cap to prevent contaminants from entering the mast arm.
10. The contractor shall use split bolt or #11 crimp for all neutral conductors in pull boxes.

D. Conduits

1. All signal conduits shall be 3-inch with 2 conduits installed for all street crossings.
2. If approved by Traffic Engineering and Traffic Operations Division for installation, 2 additional 4-inch conduits or one 6-inch conduit are now required in pole foundations to later incorporate the installation of Cell Tower conductors.
3. Use galvanized conduit for exposed, above-ground runs through the first sweep below grade.

4. Place red warning tape in all conduit trenches, 12 inches below final grade, witnessed by the city's Traffic Signal Inspector.
5. Use Schedule 40 PVC, except for service runs above ground.
6. Avoid installing conduit or pull boxes in the medians, unless otherwise directed by Traffic Engineering.
7. Traffic signal conduit sweep radius shall be a minimum of 12 inch and ITS conduit sweep radius shall be 36-inch minimum.

E. Pull Boxes

1. All pull boxes shall be fiber composite type and shall include minimum 8-inch extension on main pull box. All pull boxes require sump #57 rock, per ADOT standards.
2. Size all boxes in accordance with ADOT sized #7 called for on the prints or as specified by the Traffic Signal Inspector. All pull boxes shall be sized #7, the main pull box shall be size #7 with minimum 8-inch extension.
3. Additional and/ or larger pull boxes may be needed for fiber communications. Contact Traffic Management Center for direction.
4. Do not place pull boxes in traveled roadways. Conduit must be extended where necessary to relocate pull box to a non-traveled area. However, if the conduit cannot maintain a straight route, install a new conduit run.
5. Use pull boxes at all corners. When possible, locate pull boxes adjacent to sidewalks rather than in the sidewalk.
6. Communication and all other low-voltage cable shall be pulled continuously from service point back to controller cabinet, with no breaks or splices.
7. Mark all traffic signal pull boxes "Traffic Signal" on the lid.

F. Lighting

1. Luminaires shall be provided on all signal poles unless there is a utility conflict or unless directed otherwise by the Traffic Engineering Division. Luminaire wire connections will only be made in pull boxes and not brought into the signal controller cabinet.
2. All street lights will be connected in the junction box with a 10 ampere in-line fuse holder (non-locking type), refer to QPL for approved products.

G. Emergency Vehicle Pre-Emption

1. Emergency vehicle pre-emption shall be used for all directions and at all locations, unless otherwise directed by the Traffic Engineering Division. Additional sensors may be necessary if approaches are offset or vision is obstructed. All receivers shall be GTT 722, dual sensor-dual direction detectors.
2. Do not splice preemption detector wire between pole connection and cabinet termination.
3. Tape and color-code all preemption detector cables.
4. Phase selector shall be GTT Model 762.

H. Phasing Standard

1. The Traffic Engineering Division will determine all intersection phasing. Left-turn phasing will operate as lag-left unless otherwise directed by Traffic Engineering. Typical phasing is shown in Appendix 5-4A.

2. The signal controller must be wired by a certified IMSA Level II Signal Technician.
- I. **Electrical Power**
 1. Contact the applicable power provider to determine source for traffic signal power and to coordinate applicable requirements.
 2. Show the electrical service address on the signal plan. The address may be obtained from the COS (One Stop Shop) Records Department, 480-312-2500.
 3. The contractor must obtain an electrical service permit from the COS One Stop Shop, One Civic Center, 7447 East Indian School Road.
 - J. **Traffic Signal System (Communications)**

Interconnect all traffic signals to the COS Traffic Signal System by means of fiber optic communication cable or wireless IP, per direction of Traffic Operations. Contact Traffic Management Center at 480-312-7777 for information.
 - K. **Signing**

All regulatory, warning and route marker signs shall be provided with the traffic signal installation and shall be in accordance with the Manual on Uniform Traffic Control Devices. Metro street name signs or LED lighted signs (refer to Section 5-5), as required, shall be installed on signal poles per COS standards. Refer to COS Standard Detail 2134.

All wiring for LED signs shall be marked with brown tape.
 - L. **Striping**

All necessary striping shall be provided with the traffic signal installation and shall be in accordance with the Manual on Uniform Traffic Control Devices. Crosswalks shall be installed prior to the intersection being energized. Refer to Section 5-5, Signs and Markings for details.
 - M. **Removal and Salvage**
 1. Keep all existing traffic signal equipment and streetlights in operation until new installations are operational. Refer to Section 5-4.303.
 2. Keep all pedestrian and vehicle detection in operation during construction. Construction staging to avoid existing detectors, or the installation of temporary detectors will be required to maintain detection during construction.
 3. Keep existing communications to the signal network in operation during construction.
 4. Remove foundations to at least 36 inches below grade or as directed by the COS inspector.

CONSTRUCTION PLAN SUBMITTALS

5-4.200

Traffic signal plans shall be submitted to the One Stop Shop and must comply with all requirements of this manual. Two sets of Mylar plans are required to receive final project approval. One set will be approved and returned to the submitter; one set will be forwarded to the Traffic Engineering Division.

A final signal plan shall be submitted in MicroStation format, current version, and must be submitted to the Traffic Engineering Division no later than 10 working days after final approval.

“As-built” plans must be completed by the designer in the same MicroStation format and submitted to Traffic Engineering Division within 15 working days after the signal is energized for public use. Any changes reflected on the plans shall be crossed out and new locations shown in bold.

TRAFFIC SIGNAL PLAN CONTENT

5-4.300

PLAN CONTENT

5-4.301

Traffic signal plans shall be developed in accordance with the requirements of Chapter 1 and conform to ADOT standard practices. As a general guide, the traffic signal plan layout shall be drawn at 1 inch = 20 feet scale, shall be scalable when printed “half-size”, and shall include the following items:

- A. Locate and identify ALL existing and/or proposed improvements, above and below ground, within 200 feet of the intersection. INCLUDE ALL UTILITIES.
- B. Locate and identify ALL existing and/or proposed pavement marking and signing, include turn-arrows for exclusive turn lanes.
- C. Locate existing vegetation (trees, etc.), which could conflict with any proposed equipment locations or impact required signal visibility distances.
- D. Provide a profile layout when vertical roadway alignment may impact traffic signal visibility requirements. (1 inch = 40 inches-scale for profile is acceptable.)
- E. Provide bearings for each leg of the intersection when deflection is greater than 2 degrees. Provide roadway curve data if applicable.
- F. Locate all traffic signal equipment (poles, controller cabinet, electric service cabinet and telephone drop, etc.) by station and offset dimension.
- G. All traffic signal poles, conduits and equipment must be located within public rights-of-way or easement.
- H. Controller and cabinet must be Econolite COBALT system with type 332 Hybrid cabinet, with extension base and access panel.
- I. Electric service cabinet and uninterruptured power supplies (UPS), if specified, shall be selected from the QPL, or approved equivalent.
- J. Designer shall coordinate the location of electric service with Salt River Project (SRP) or Arizona Public Service (APS) and provide detail on the plan with appropriate notes.
- K. Provide address for electric service cabinet, available through COS Records Department.
- L. Locate conduit with fiber optic communication cable back to signal controller.
- M. Provide emergency vehicle signal pre-emption, using GTT optical detectors model 722 or approved equivalent.
- N. Provide phasing diagram for initial signal operation and ultimate 8-phase operation, unless directed otherwise by the Traffic Engineering Division. Refer to Appendix 5.4.A for layout.
- O. Provide conductor schedule indicating conduit run number, conduit size, wire type/size, phase and any other pertinent information.
- P. Details of any items not covered by standards.

- Q. All signal pole foundations shall have two 3-inch PVC conduits leading to adjacent pull box, except all A, E and F foundations shall have one 3-inch PVC conduit. Verify with Traffic Engineering at 480-312-7641 before designing foundation conduits. Two 4-inch or one 6-inch conduit stubbed out of the foundation may be required for future cell tower installation.
- R. All plans must include a signal system number on the plan set. Contact the Traffic Management Center at 480-312-7777 to acquire the signal system number.
- S. All plans must include the Traffic Signal Approval Block, as shown in Figure 5-4.4.

Date	Revision			By	
Project Title					
Review By		Designed By		Drawn By	
Date	As-Built Date	Bid No.	Scale	Sheet OF	
Engineers Stamp		 <p style="text-align: center;">TRANSPORTATION DEPARTMENT TRAFFIC ENGINEERING 7447 E Indian School Road Scottsdale, AZ 85251</p>			
TRAFFIC SIGNAL APPROVAL BLOCK					
Engineering Coordination Manager (or designee)		Engineering Review		Traffic Engineering Director (or designee)	

FIGURE 5-4.4 TRAFFIC SIGNAL APPROVAL BLOCK

GENERAL NOTES

5-4.302

Include the current General Notes on all COS Traffic Signal Construction Plans. As of the adoption of this document, Figure 5-4.5 represents the current General Notes. Contact Traffic Operations to confirm for use. Refer to Chapter 1 for additional notes that may also be required.

GENERAL CONSTRUCTION NOTES
<ol style="list-style-type: none"> 1. All traffic signal equipment and all construction in public rights-of-way or in easements granted for public use shall conform to: <ol style="list-style-type: none"> a. The ADOT standard drawings and specifications, b. The Maricopa Association of Governments (MAG) Uniform Standard Specifications and Details for Public Works Construction, c. The COS Supplement to MAG Standard Specifications and Details for Public Works Construction, and d. The COS Traffic Signal requirements 2. Traffic control shall conform to the City of Phoenix Traffic Barricade Manual and/or as directed by the city Public Works Inspector.

GENERAL CONSTRUCTION NOTES

3. Utility locations shown are based upon the best available information. The Contractor shall contact Arizona 811 (formerly Arizona Blue Stake) at 602-659-7500 before construction and verify actual utility locations.
4. Traffic signal poles, mast arms and service cabinets shall be painted with 2 coats of enamel paint meeting ADOT Specification Section #1002.
5. All pull boxes shall be ADOT standard type #7 as previously noted. The main pull box shall be an ADOT #7 Ext., with 18-inch drainage, consisting of #57 rock, per ADOT spec.
6. A ground rod shall be installed within the customer side of the electrical service panel and in the control cabinet foundation and an attached #4 bare grounding conductor.
7. Pavement replacement shall conform to COS Standard Detail 2200 and 2201. Sidewalk replacement shall conform to MAG Standard Detail 230.
8. Metro Street Name Signs shall be installed on traffic signal mast arms per COS Supplement to MAG Specifications, Section 402.3.4 and COS Standard Detail 2134.
9. Applicable signal and pedestrian indications shall be LED type lamps that meet ITE Equipment and Materials Standards for LED traffic signal indications.
10. Emergency Vehicle Pre-Emption shall be field-adjusted to optimize reception. All detectors shall be GTT model 722.
11. All existing traffic control devices (including pedestrian and vehicle detectors, communications, closed circuit television (CCTV) and stop signs) and street lights shall remain in operation until new installations are energized and operational. Any traffic detectors disturbed during construction shall be replaced with temporary detectors until the final detection system is in place and operational.
12. Any removed COS equipment shall be salvaged and returned to the COS Traffic Signal Shop at 9191 E. San Salvador, Scottsdale. All salvaged equipment shall be dismantled.
13. Questions concerning traffic signal design should be directed to the "Signal Designer, Firm or Agency, Address, Phone Number."
14. The electrical service address is: XXXXXXXXXX.
15. Prior to START of construction the contractor shall contact the COS Traffic Operations Division at 480-312-5620 to coordinate power authorization, cabinet set-up, inspection requirements and the pre-construction meeting. COS Traffic Signals shall be called 48 hours prior to all inspection points.
16. Prior to START of construction the contractor shall contact the electric power provider to confirm power location and to schedule inspection.
17. All wires shall be color coded with tape as shown in COS Standard Detail 2141.
18. All signal foundations shall be flat, not dished or blocked/out. Foundations shall be no lower than back of sidewalk and/or 6-½ inch above the finished edge of the road and shall not be grouted.

GENERAL CONSTRUCTION NOTES

19. All traffic signal poles, new, borrowed or existing, shall be brought to “like new” condition, including unused holes welded, pole painted, wire upgraded to IMSA cable.

FIGURE 5-4.5 GENERAL CONSTRUCTION NOTES BLOCK

CONSTRUCTION VEHICLE DETECTION

For all construction projects in the city with duration of 15 days or more, temporary vehicle detection will be required for all approaches at signalized intersections that currently have detection which will be disturbed by the construction. In addition, traffic signal communications to the central signal computer and closed-circuit television (CCTV, if present) shall be maintained continuously during the project. The contractor or sub-contractor through the life of the project shall maintain the detection zones and communications by ensuring full functionality 24 hours a day, 7 days a week.

The contractor shall be responsible for the on-going operation of the detection equipment, which may require redeployment of detection zones as traffic barricading and lane use changes require.

CIRCUITRY

Each signal phase wire shall be coded with colored tape in the pull box as shown in COS Standard Detail No. 2141 and Figure 5-4.6 below through Figure 5-4.8.

5-4.303

5-4.400

20 CONDUCTOR IMSA CABLE				
Cable #1	Cable #2	Conductor Cable		Signal Interval
		Basic Color	Tracer Stripe	
Phase 1	Phase 5	Red	Solid	Red
		Orange	Solid	Yellow
		Green	Solid	Green
Phase 2	Phase 6	Red	Black	Red
		Orange	Black	Yellow
		Green	Black	Green
Phase 3	Phase 7	Red	White	Red
		Blue	White	Yellow
		Green	White	Green
Phase 4	Phase 8	Red	Green	Red
		Orange	Red	Yellow
		Blue	Red	Green
Phase 1 or 2 PED*	Ph 5 Or 6 PED*	Blue	Solid	Walk
		Black	Solid	Don't Walk
Phase 1 or 2 PB*	Ph 5 Or 6 PB*	White	Red	Push Button
Ph 3 Or 4 PED*	Ph 7 Or 8 PED*	Blue	Black	Walk
		Black	White	Don't Walk
Ph 3 Or 4 PB*	Ph 7 Or 8 PB*	Black	Red	Push Button
All Phases	All Phases	White	Solid	P.B. Common
		White	Black	Spare

*Cable #1 shall be marked with an individual wrap of White Tape.
 Cable #2 shall be marked with two individual wraps of White Tape, side by side with a 1/2 inch gap between wraps.
 Cables shall have 12 inches of Black Insulation Jacket extending past Conduit Bell End.
 Individual conductors in the cable shall be tagged as to assigned phase.
 * Refer to Engineering Timing Sheet to determine Ped Phases.
 All wire groups in pull boxes must be tape coded per Scottsdale Directional Tape Color Code.*

FIGURE 5-4.6 IMSA CABLE 19-1, #14 AWG (STRANDED) 20 CONDUCTOR

4 CONDUCTOR and 7 CONDUCTOR IMSA CABLE (STRANDED)																																			
<table border="1" style="width: 100%; border-collapse: collapse;"> <thead> <tr> <th colspan="2" style="text-align: left; padding: 2px;">SIGNAL HEADS FOR G or Q HEAD, FUTURE OR INITIAL</th> </tr> <tr> <th colspan="2" style="text-align: left; padding: 2px;">7 Conductor Cable</th> </tr> <tr> <th style="width: 50%; padding: 2px;">Basic Color</th> <th style="padding: 2px;">Signal Interval</th> </tr> </thead> <tbody> <tr> <td style="padding: 2px;">Red</td> <td style="padding: 2px;">Red</td> </tr> <tr> <td style="padding: 2px;">Black</td> <td style="padding: 2px;">Yellow</td> </tr> <tr> <td style="padding: 2px;">Green</td> <td style="padding: 2px;">Green</td> </tr> <tr> <td style="padding: 2px;">Orange</td> <td style="padding: 2px;">Yellow Arrow</td> </tr> <tr> <td style="padding: 2px;">Blue</td> <td style="padding: 2px;">Green Arrow</td> </tr> <tr> <td style="padding: 2px;">White</td> <td style="padding: 2px;">Veh. Com</td> </tr> <tr> <td style="padding: 2px;">White/ Black</td> <td style="padding: 2px;">Spare</td> </tr> </tbody> </table>	SIGNAL HEADS FOR G or Q HEAD, FUTURE OR INITIAL		7 Conductor Cable		Basic Color	Signal Interval	Red	Red	Black	Yellow	Green	Green	Orange	Yellow Arrow	Blue	Green Arrow	White	Veh. Com	White/ Black	Spare	<table border="1" style="width: 100%; border-collapse: collapse;"> <thead> <tr> <th colspan="2" style="text-align: left; padding: 2px;">SIGNAL HEADS INBOARD AND SIDE MOUNT</th> </tr> <tr> <th colspan="2" style="text-align: left; padding: 2px;">4 Conductor Cable</th> </tr> <tr> <th style="width: 50%; padding: 2px;">Basic Color</th> <th style="padding: 2px;">Signal Interval</th> </tr> </thead> <tbody> <tr> <td style="padding: 2px;">Red</td> <td style="padding: 2px;">Red</td> </tr> <tr> <td style="padding: 2px;">Black</td> <td style="padding: 2px;">Yellow</td> </tr> <tr> <td style="padding: 2px;">Green</td> <td style="padding: 2px;">Green</td> </tr> <tr> <td style="padding: 2px;">White</td> <td style="padding: 2px;">Veh. Common</td> </tr> </tbody> </table>	SIGNAL HEADS INBOARD AND SIDE MOUNT		4 Conductor Cable		Basic Color	Signal Interval	Red	Red	Black	Yellow	Green	Green	White	Veh. Common
SIGNAL HEADS FOR G or Q HEAD, FUTURE OR INITIAL																																			
7 Conductor Cable																																			
Basic Color	Signal Interval																																		
Red	Red																																		
Black	Yellow																																		
Green	Green																																		
Orange	Yellow Arrow																																		
Blue	Green Arrow																																		
White	Veh. Com																																		
White/ Black	Spare																																		
SIGNAL HEADS INBOARD AND SIDE MOUNT																																			
4 Conductor Cable																																			
Basic Color	Signal Interval																																		
Red	Red																																		
Black	Yellow																																		
Green	Green																																		
White	Veh. Common																																		
<table border="1" style="width: 100%; border-collapse: collapse;"> <thead> <tr> <th colspan="2" style="text-align: left; padding: 2px;">PEDESTRIAN HEADS</th> </tr> <tr> <th colspan="2" style="text-align: left; padding: 2px;">4 Conductor Cable</th> </tr> <tr> <th style="width: 50%; padding: 2px;">Basic Color</th> <th style="padding: 2px;">Signal Interval</th> </tr> </thead> <tbody> <tr> <td style="padding: 2px;">Red</td> <td style="padding: 2px;">Don't Walk</td> </tr> <tr> <td style="padding: 2px;">Green</td> <td style="padding: 2px;">Walk</td> </tr> <tr> <td style="padding: 2px;">White</td> <td style="padding: 2px;">Ped. Com.</td> </tr> <tr> <td style="padding: 2px;">Black</td> <td style="padding: 2px;">Spare</td> </tr> </tbody> </table>	PEDESTRIAN HEADS		4 Conductor Cable		Basic Color	Signal Interval	Red	Don't Walk	Green	Walk	White	Ped. Com.	Black	Spare	<table border="1" style="width: 100%; border-collapse: collapse;"> <thead> <tr> <th colspan="2" style="text-align: left; padding: 2px;">PUSHBUTTON</th> </tr> <tr> <th colspan="2" style="text-align: left; padding: 2px;">2 Conductor Cable</th> </tr> <tr> <th style="width: 50%; padding: 2px;">Basic Color</th> <th style="padding: 2px;">Push Button Station</th> </tr> </thead> <tbody> <tr> <td style="padding: 2px;">Red</td> <td style="padding: 2px;">Push Button</td> </tr> <tr> <td style="padding: 2px;">White</td> <td style="padding: 2px;">P.B. Common</td> </tr> <tr> <td style="padding: 2px;">Green</td> <td style="padding: 2px;">Spare</td> </tr> <tr> <td style="padding: 2px;">Black</td> <td style="padding: 2px;">Spare</td> </tr> </tbody> </table>	PUSHBUTTON		2 Conductor Cable		Basic Color	Push Button Station	Red	Push Button	White	P.B. Common	Green	Spare	Black	Spare						
PEDESTRIAN HEADS																																			
4 Conductor Cable																																			
Basic Color	Signal Interval																																		
Red	Don't Walk																																		
Green	Walk																																		
White	Ped. Com.																																		
Black	Spare																																		
PUSHBUTTON																																			
2 Conductor Cable																																			
Basic Color	Push Button Station																																		
Red	Push Button																																		
White	P.B. Common																																		
Green	Spare																																		
Black	Spare																																		
<p><i>Cables shall be tagged as to assigned phase, per Scottsdale Directional Tape Color Code. Cable shall be pulled to all tenons on mast arm. Any unused tenons shall be capped. Cables shall extend 18 inches into signal head with 8 inches of Black Insulation Jacket. Cables shall have 12 inches of Black Insulation Jacket extending past conduit bell end. Cables shall be identified in pull boxes by individual wraps of colored tape, incrementing by one, starting with inboard side mount as #1.</i></p>																																			

FIGURE 5-4.7 IMSA CABLE 19-1, #14 AWG (STRANDED)

4 AND 7 CONDUCTOR (STRANDED)	
THROUGHGS	
North Bound (NB) = Red East Bound (EB) = Green	South Bound (SB) = Yellow West Bound (WB) = Blue
TURNS	
Left Turn (LT) = Color + White Right Turn (RT) = Color + Black Example: WBLT = Blue + White	
PEDESTRIAN CROSSINGS	
Pedestrian Heads = Color + Purple Examples: NB = Red + Purple EB = Green + Purple	
PEDESTRIAN PUSH BUTTONS	
Color + Orange	
OVERLAPS	
Color + Brown	

FIGURE 5-4.8 DIRECTIONAL TAPE COLOR CODE

STRUCTURES

5-4.500

A. Qualified Products List (QPL)

A QPL has been established for Scottsdale traffic signal structures, refer to Appendix 5-4B.

All contractors submitting bids for traffic structures not on the QPL must provide documentation for city review in advance of their bid submittal. Submit the following for city's review:

1. Traffic signal structure drawings and specifications.
2. Traffic signal structure load calculations (based on the maximum city loading), signed and sealed by an engineer registered in the State of Arizona.
3. Documentation of all deviations from ADOT specifications.
4. A letter signed and stamped by a State of Arizona registered professional engineer stating that the signal structure will safely support the maximum loading as described by the city.
5. Recommended foundation designs and specifications for all traffic signal structures, except the ADOT/Scottsdale traffic signal structures.

B. Traffic Signal Structures ADOT/Scottsdale

The base specification and warranty requirements for the ADOT/Scottsdale traffic signal structure shall be:

1. Standard Specification for Road and Bridge Construction - ADOT (Current)
2. Traffic Signals and Lighting, Standard Drawings - ADOT (Current)

PHASING

The city desires to use NEMA phasing to streamline traffic signal operations. To that end, the following policy has been put in place:

- A. The NEMA movements should be oriented such that phases 2 and 6 align with the major street thru movement. For intersections with a north-south major street, phase 2 is southbound and phase 6 is northbound. For intersections with an east-west major street, phase 2 is eastbound and phase 6 is westbound.
- B. The geographic orientation of phasing is shown in Figure 5-4A1, below:

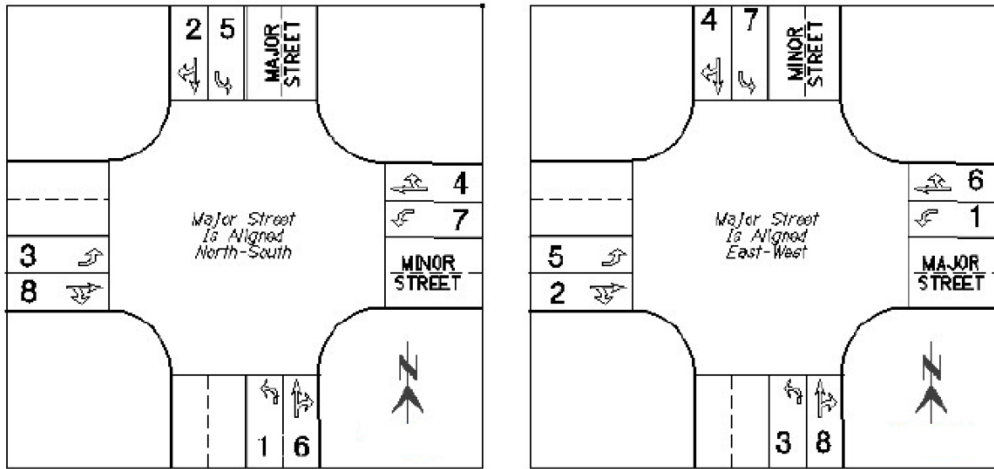

FIGURE 5-4A1 NEMA STANDARD MOVEMENTS

QUALIFIED PRODUCTS LIST

SCOTTSDALE PUBLIC WORKS DEPARTMENT STREET OPERATIONS DIVISION QUALIFIED PRODUCTS LIST

Traffic Signal System Cabinet: Model 332 Hybrid Cabinet, Scottsdale Specifications Safetran Traffic Systems, Inc.	Traffic Signal Controller Units: Cobalt - RM w/Ethernet Port Econolite Control Products, Inc.	Conflict Monitor: Model 210E Eberle Design, Inc.
Flasher: Model 204 Solid State Devices 204K Eberle Design, Inc.	Load Switch: EDI 200-SF Solid State Device 200K Eberle Design, Inc.	Audio Crosswalk ADA Device: AGPS Campbell
Traffic Signal Pre-emption Devices: Model 722, Detector Model 762 Phase Selector Global Traffic Technologies (GTT)	Photo Electric Cell: Model 2172 NP3 Associated Lighting Representatives (ALR)	Flash Transfer Relay: 21XBXPL, 120VAC 50/60 Hz Struthers-Dunn
Opticom Belden 3C20 cable (B, O, Y)	Malfunction Management Unit (MMU) MMU2-16LEip-RM Smart Monitor Safetran Traffic Systems, Inc.	Electric Service Cabinet, Models: MUEG16-M125 Myers Power Products CP3B11115AWSP3 Milbank Manufacturing Company
Two Channel DC Isolators: Model 242 General Devices and Instruments PDC Model 242 Detector Systems	Video Detection: Vantage Next® Iteris, Inc.	Power Distribution Assembly (PDA): Compatible with 330 Safetran Traffic Systems, Inc.
Power Supply: PS-250-RM TS2 Safetran Traffic Systems, Inc.	Traffic Signal Conductor Cable: IMSA 19-1 "14 AWG" stranded cable, in 20, 7 or 4 conductor	Loop Wire: IMSA 51-5 with orange jacket #14 AWG
CCTV: Q6045-E Mk II PTZ Dome Network Camera AXIS	Loop Lead-in: IMSA 50-2, #14 AWG	Streetlight Cable: 12/2 UF-B Wire with ground, outdoor rated Romex
	Wire Connectors: Ideal Weatherproof 30-1262J	

QUALIFIED PRODUCTS LIST

The effective period of this QPL is indeterminate. Manufacturers are required to notify the ITS Signals Manager of any changes affecting design or performance in the product that has been approved. This includes all components listed in manuals and all engineering changes.

Manufacturers not on the list who want their assemblies or units tested to be added to the QPL for future bids should submit a written request to the ITS Signals Manager at the Street Operations address below.

Failure to perform satisfactorily on purchase orders by failing to meet delivery schedules or maintain a high rate of acceptance may result in being removed from the QPL.

Street Operations Division
Public Works Department
9191 E. San Salvador
Scottsdale, AZ 85258
Phone: 480-312-5620

Traffic Signal Structures:

ADOT/Scottsdale

Valmont Industries, Inc.

Drawing #DB00181, no Rev.

Valmont Industries, Inc.

Drawing #DB00182, no Rev.

Couplet "Trombone" Type Pole

Valmont Industries, Inc.

Drawing #DB00243

Type "R" Mod-Cell Tower Monopole

Drawing #DB00707

American Pole Products Division

Drawing #01127 for "Q" and "R" poles

Millerbernd

Drawings 780B14, 780B15, 780B16,
780B17, 780B2430, 730A495

SIGNS AND MARKINGS

5-5

This section provides the procedures and criteria for designing traffic signs and pavement markings within the city. It presents standards for plan layout, signing, and striping.

GENERAL INFORMATION

5-5.000

USE OF NATIONAL AND LOCAL STANDARDS

5-5.001

The following current publications are to be used in conjunction with the design criteria in this manual for traffic signs and markings design work.

- A. MUTCD - USDOT/FHWA, current edition.
- B. Signing and Marking - Standard Drawings - ADOT
- C. ADOT Traffic Control Design Guidelines - ADOT
- D. Manual of Approved Signs (MOAS) - ADOT
- E. Traffic Engineering Policies, Guidelines and Procedures - ADOT
- F. Supplement to MAG Uniform Standard Specifications for Public Works Construction - City of Scottsdale
- G. Supplemental Standard Details for Public Works Construction – City of Scottsdale
- H. Uniform Standard Specifications for Public Works Construction - MAG
- I. Uniform Standard Details for Public Works Construction - MAG
- J. Traffic Barricade Manual - City of Phoenix

DESIGN STANDARDS

5-5.100

Design is to be in accordance with the MUTCD unless modified by the city as noted. The requirements of the MUTCD apply to privately owned facilities where the public can travel without restrictions.

SIGNING

5-5.101

- A. All sign posts are to be telespar pre-punched square steel tubing per [COS Standard Detail](#) No. 2131. American Society for Testing Materials (ASTM) Type XI Sheeting (minimum) shall be used for all warning, regulatory, street name signs, advance street name signs, and metro signs. All signs shall have a premium transparent protective overlay film applied to the sign face (3M-1160 or equivalent) and shall consist of a matched component system. All metro signs shall comply with the [COS Standard Detail](#) No. 2134-4. School warning signs and accompanying placards must be ASTM Type XI fluorescent yellow green sheeting.
- B. Streetlight poles should be used for sign mounting when the light pole is within 50 feet of the proposed sign location.
- C. "No Parking" signs shall only be used when the following site conditions exist:
 - 1. When any right-hand lane (curb lane) is 16 feet or wider, or if a paved shoulder area is present.
 - 2. Where on-street parking could be expected to occur, such as commercial areas where businesses have direct frontage on the street.When the above criteria exist "No Parking" signs (R8-3a, 12-inch x 18 inch) with an arrow (single direction or bi-directional) below the "P" symbol on the sign to designate the direction of the restriction shall be installed approximately every 350-400 feet along the length of the project. No parking signs shall be installed approximately 5 feet from the back of curb at a 45-degree angle to the curb.

Street light poles should be used for sign mounting if it is located approximately within 50 feet of the proposed sign location.

- D. Speed limit signs (R2-1) are to be installed at 4 signs per mile, per direction.
- E. Stop signs (R1-1) are to be 30-inch x 30-inch minimum size. Larger stop signs may be required on high-speed and multi-lane conventional roads as required in Table 2B-1, chapter 2B of the MUTCD 2009 edition.
- F. Street name signs in subdivisions must conform to the [City of Scottsdale Supplement](#) to MAG Uniform Standard Specifications for Public Works.
- G. Advance street name, directional arrows, chevrons, one-way signs are to be installed at a height of 4 feet to the bottom of sign and placed so they are not obstructed by vegetation. Advance street name signs are to be installed in medians whenever possible.
- H. Median nose signing is to be installed per [COS Standard Detail](#) No. 2133 as follows:
 - 1. Type "A" is to be installed at signalized intersections and the first median nose in a succession of medians, or where the gap between medians exceeds 250 feet.
 - 2. Type "B" is to be used at all other median nose locations.
- I. Photo Enforcement Signing
 - All photo enforcement signing shall comply with DS&PM section 5-5.101 A
 - 1. Fixed Sites and portable tower sites
 - a. Two R10-18 Mod signs (Figure 5-5.1) shall be installed.
 - b. The first R10-18 Mod. Sign, closest to the photo device, is installed approximately 300' before the photo enforcement system and may be installed below a regulatory sign. The second R10-18 Mod. Sign needs to be installed between 200'-600' from the first sign. See Arizona Revised Statutes (ARS) 28-1204 B.1.
 - c. A speed limit sign (R2-1) shall be present in between the two R10-18 Mod. Signs. A S4-5 sign shall be mounted below the R2-1 between the two R10-18 Modified signs in advance of school zone sites. The mounting of the S4-5 sign shall comply with MUTCD section 2A.18.
 - 2. Mobile Van Sites
 - a. Speed limit of 40 mph or less: One R10-18 Mod sign shall be posted approximately 300' in advance of the photo enforcement equipment
 - b. Speed limit of 45 mph or greater: Criteria for fixed photo enforcement sites shall be used.

Typestyle shall be Highway Gothic Mod C or D. Text: upper case word "NOTICE" shall be black, letters 6" high, on Yellow background. "TRAFFIC LAWS PHOTO ENFORCED" shall be black, upper case and 3" high; camera symbol shall be black, 6.5" high on white background. R10-18 Modified - 30" H x 36" W



REF. ARS 28-1204 AND MUTCD 2B.55 & 2C.61
 FIGURE 5-5.1 PHOTO ENFORCEMENT SIGN

STRIPING

5-5.102

- A. All permanent longitudinal pavement striping (centerlines, lane lines, bay lines) shall be 90 millimeter (mil) extruded thermoplastic. Reflective beads shall be applied in accordance with section 704 of ADOT’s Standard Specifications for Road and Bridge Construction. All permanent lateral pavement striping (stop lines, crosswalk lines) shall be 90 mil extruded thermoplastic. Reflective beads shall be applied as per Section 704 above.
- B. All temporary pavement markings shall be reflective traffic paint.
- C. All median noses shall be painted with reflectorized traffic paint and have Type D yellow raised pavement markers (RPMs) per [COS Standard Detail](#) No. 2225 and 2226.
- D. COS striping and marking standards are shown in Figure 5-5.2 through Figure 5-5.16.
 - 1. Skip (Broken) Lines per MUTCD Section 3A.06
 - a. Skip lines direct lanes of through traffic
 - b. Striping: 4-inch-wide lines, 10 feet long, 30 feet gaps
 - c. Include RPMs centered within gaps:
 - i. Yellow Type D 2-way reflective
 - ii. White Type G 1-way reflective

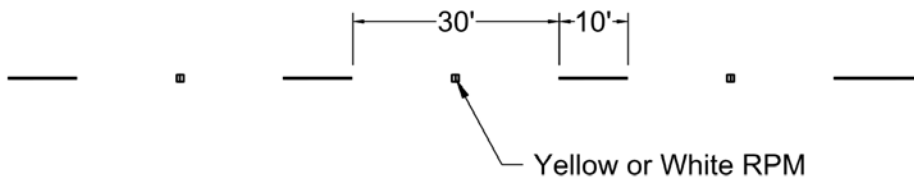

FIGURE 5-5.2 SKIP LINES MARKINGS

- 2. Guide Lines per MUTCD Section 3A.06
 - a. Direct traffic or emphasize certain movements
 - b. Striping: typical 4-inch-wide lines (8 inch when matching an existing solid line), 2 feet long, gaps 6 feet

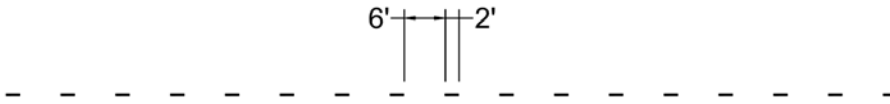

FIGURE 5-5.3 GUIDE LINES MARKINGS

- 3. Lane Drop Lines per MUTCD Section 3A.06
 - Striping: 8-inch-wide lines, 3 feet long, gaps 9 feet



FIGURE 5-5.4 LANE DROP LINES

- 4. Edge Lines
 - a. 4-inch-wide White off the edge of pavement where curbs are omitted
 - b. 8-inch-wide White between travel lane and bike lane, unless directed to be 4-inch-wide by the Transportation Director or assignee
 - c. 8-inch-wide White where asphalt tapers for a curve, a lane drop, etc.



FIGURE 5-5.5 EDGE LINE MARKING

- 5. Two-Way Left Turn Lanes
 - a. All lines 4-inch-wide Yellow, skip lines to follow typical skip dimensions
 - b. Include RPMs centered within gaps: Yellow Type D 2-way reflective



FIGURE 5-5.6 TWO-WAY LEFT TURN LANE MARKINGS

6. Left Turn Bays
 - a. Used at signalized intersections and major cross streets and driveways
 - b. Arrow and "ONLY" shall be placed in left turn bays
 - c. A second arrow is placed at the top of the bay only as determined by Traffic Engineering through review
 - d. All pavement symbols, arrows and legends shall be Type 1 permanent, high performance pre-formed pavement tape (tape must perform as 3M 380I-ES series or equivalent)
 - e. Use White RPMs Type G 1-way reflective

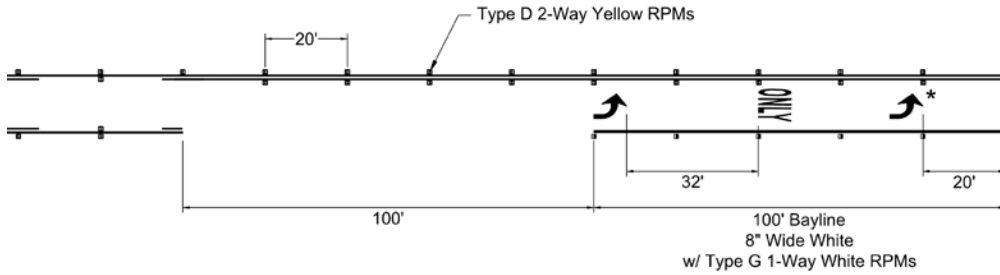

FIGURE 5-5.7 LEFT TURN BAY MARKINGS

Offset Left Turn Lanes

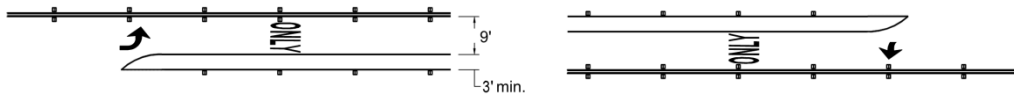

FIGURE 5-5.8 OFFSET LEFT TURN LANES

7. Left-In/Left-Out

- a. Turn and Merge Arrows as per ADOT Signing and Marking Standard Drawing M-10 1&2
- b. Concrete curb shall be 8" thick at median bullnose per MAG Detail 223
- c. Type D Roll Curb and Gutter shall be used for separating island per MAG Detail 220-1

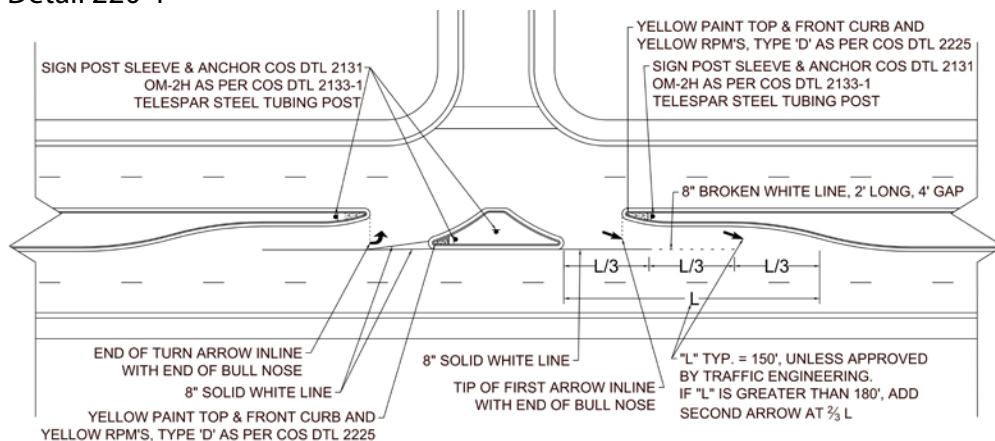

FIGURE 5-5.9 LEFT-IN/LEFT-OUT MARKINGS AND SIGNING

8. Right Turn Bay
 - a. 100 feet bay line, 8-inch-wide White line
 - b. One R3-5R
 - c. Arrow and "ONLY" shall be placed in right turn bays
 - d. If bay is 150' feet or more, a second arrow is placed at the top of the bay only as determined by Traffic Engineering through review
 - e. For turn bays at stop sign, R3-5R not to obstruct stop sign

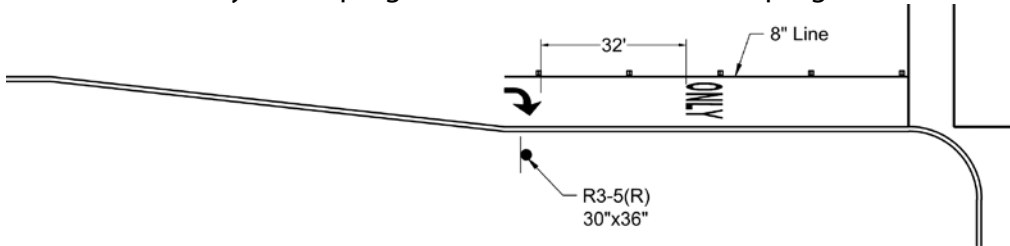

FIGURE 5-5.10 RIGHT TURN BAY MARKINGS

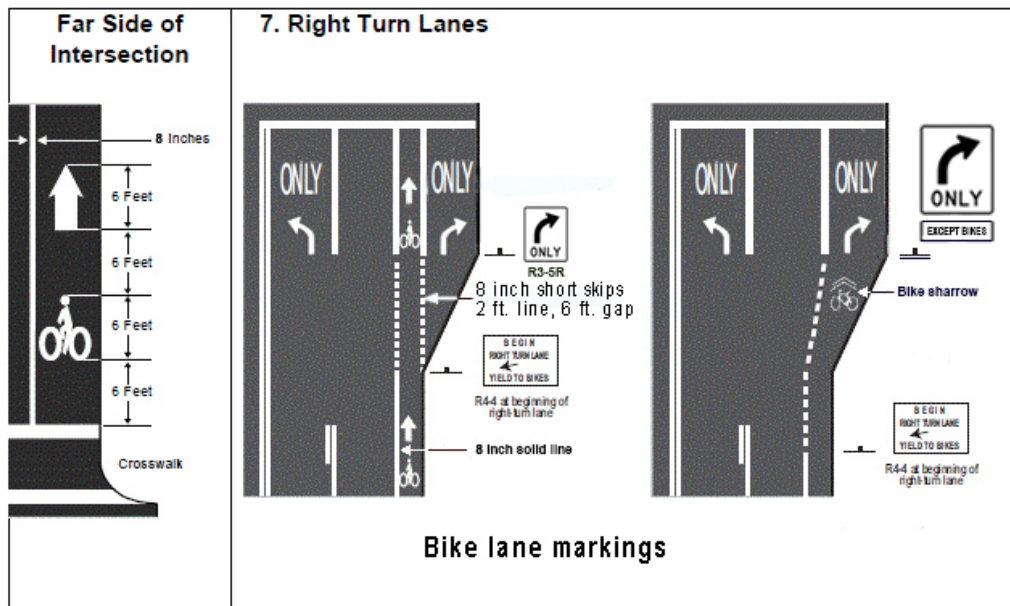
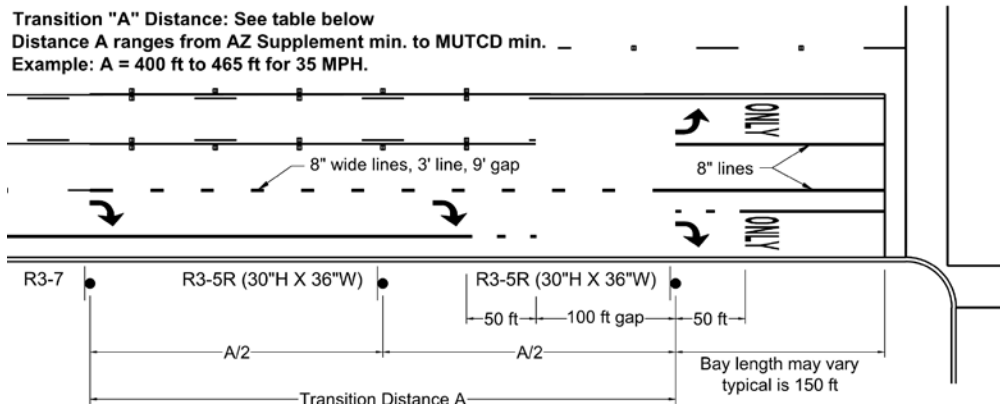

FIGURE 5-5.11 BIKE LANE MARKINGS

9. Trap Lanes



Posted or 85th Percentile Speed	AZ Supplement Condition A: Speed reduction and lane changing in heavy traffic	MUTCD
20 mph	175 ft	225 ft
25 mph	250 ft	325 ft
30 mph	325 ft	460 ft
35 mph	400 ft	565 ft
40 mph	475 ft	670 ft
45 mph	550 ft	775 ft
50 mph	625 ft	885 ft
55 mph	700 ft	990 ft
60 mph	775 ft	1,100 ft
65 mph	850 ft	1,200 ft
70 mph	925 ft	1,250 ft
75 mph	1,000 ft	1,350 ft

FIGURE 5-5.12 TRAP LANE MARKINGS

10. Lane Reduction/Merge

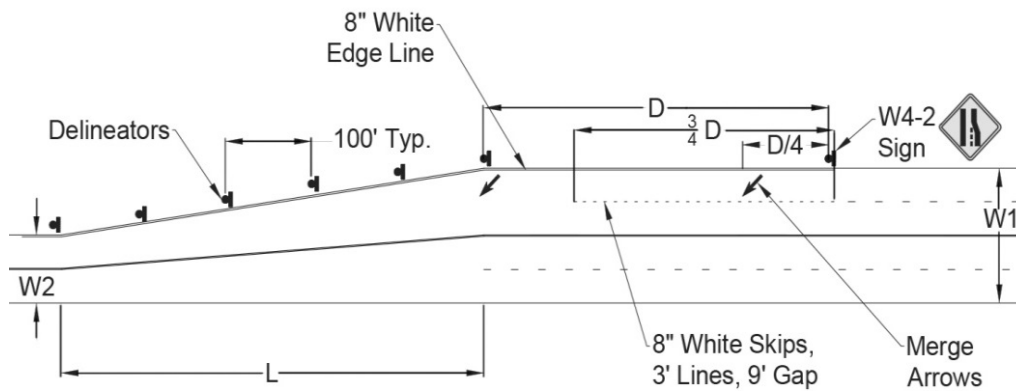

- $L = W \times S$ for speeds > 45 mph
- $L = \frac{W \times S^2}{60}$ for speeds < 45 mph
- S = Design speed for 85th percentile speed, whichever is higher
- $W = W1 - W2$
- Dimension "D" equals advance warning distance as per the 2009 MUTCD, Refer to Table 2C-4
- At least two Merge arrows should be used. If "D" ≥ 400 ft., additional arrows should be considered

FIGURE 5-5.13 LANE REDUCTION/MERGE

11. Crosswalks and Stop Bars

- a. Crosswalks are to be used at signalized intersections, all-way stops, roundabouts, and at other locations determined by Traffic Engineering.
- b. 25 M.P.H. = 12-inch wide stop bar
- c. 30 M.P.H. and greater = 18-inch wide stop bar

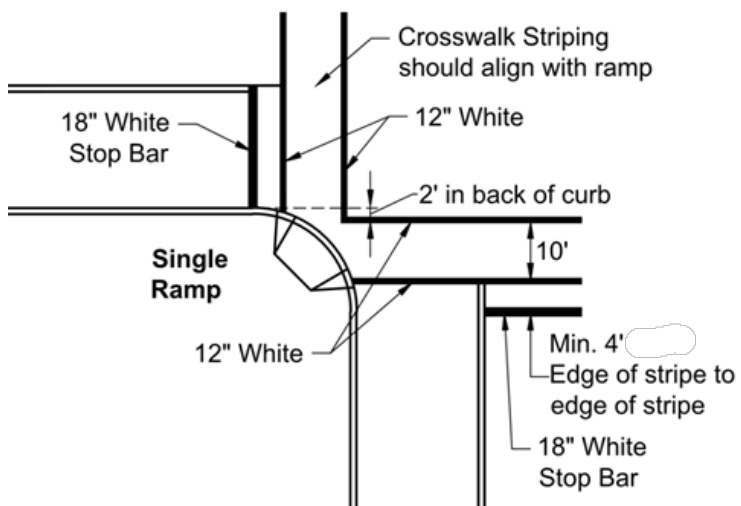

FIGURE 5-5.14 SINGLE RAMP CROSSWALK MARKINGS

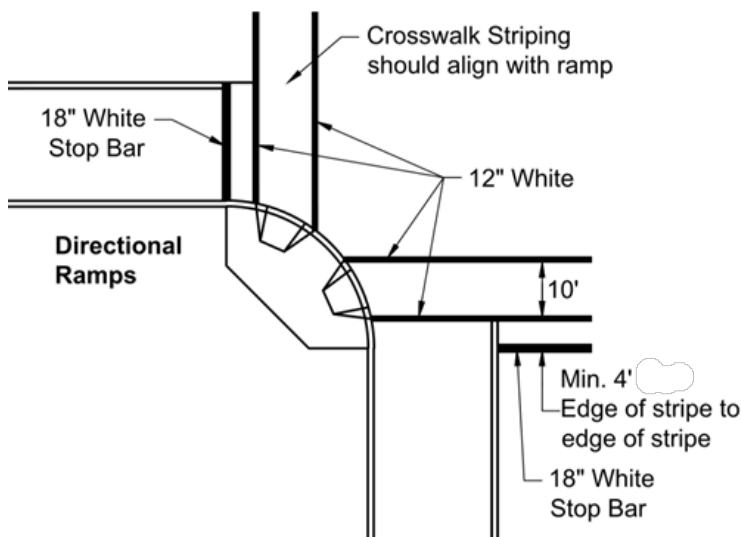

FIGURE 5-5.15 DIRECTIONAL RAMP CROSSWALK MARKINGS

12. Dual Left Turn Movement

Paint short skips through intersection

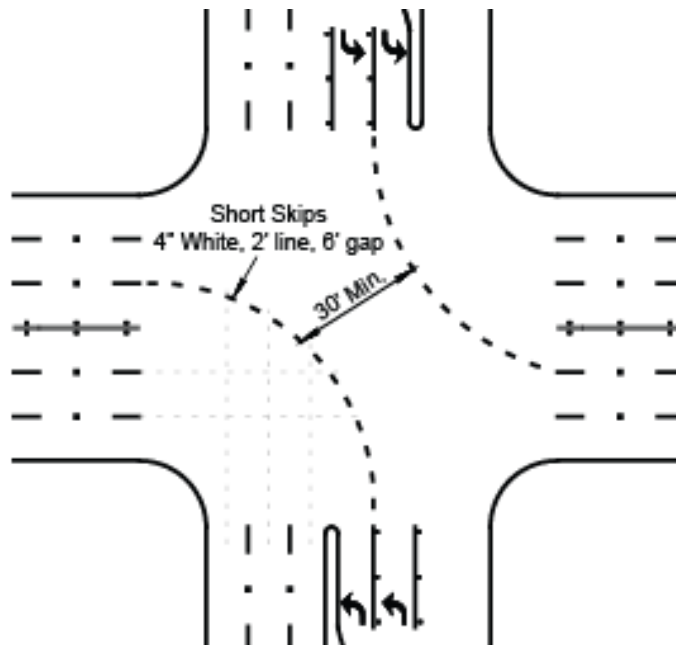

FIGURE 5-5.16 DUAL LEFT TURN INTERSECTION

13. Roundabouts

Refer to Section 5-3.124 of this manual

14. Lane Widths, Typical and Exceptions

a. Travel Lane Widths:

Travel lane widths for new street construction shall be as shown in the street cross-sections contained in Section 5-3.100. Typical lane widths are 11 feet wide; some local streets may have 10 feet wide lane widths. Alternatives to the typical lane width may be approved by the Traffic Engineering Director upon written request. The lane widths shall be determined as measured on a consistent asphalt surface from edge of asphalt, lip of gutter, or center of lane stripe.

- i. Through lanes may be reduced to 10' feet on arterial streets where there are constraints or where bike lanes are being added.
- ii. Through lanes may be reduced to 9.5' feet on collector streets where there are constraints or where bike lanes are being added.
- iii. Turn lane widths may be reduced to 9.5' feet when needed to accommodate wider through lanes or bike lanes, or when adjacent to curbing.
- iv. Through lane and turn lane widths of 9.5' feet may only be considered on straight sections of roadway with minimal truck traffic.

b. Bike lane widths:

Bike lane widths for new street construction shall be as shown in the street cross-sections contained in Section 5-3.100. Typical lane widths are 4' or 6' feet wide of asphalt not including gutters or other portions of curbing.

Alternatives to the typical lane width may be approved by the Traffic Engineering Director upon written request. The lane widths shall be determined as measured on a consistent asphalt surface from edge of asphalt, lip of gutter, or center of lane stripe.

- i. Standard bike lanes widths with curb:
 - 1) 5' feet of asphalt + 1.5' feet of gutter width with vertical curb and gutter – 6.5' feet total width, 7' to back of curb.
 - 2) 4' feet of asphalt + 2' feet of rolled curb and gutter – 6' feet total width to back of curb.
 - 3) 4' feet of asphalt + 1.5' feet of ribbon curb – 5.5' feet total width to back of curb.
- ii. Minimum bike lanes with curb:
 - 1) 4' feet of asphalt + 1.5' feet of gutter width with vertical curb and gutter – 5.5' feet total width to face of curb, 6' feet to back of curb.
 - 2) 3' feet of asphalt + 2' feet of rolled curb and gutter – 5' feet total width to back of curb.
 - 3) 3' feet of asphalt + 1.5' feet of ribbon curb – 4.5' feet total width to back of curb.

PLAN LAYOUT

5-5.200

GENERAL REQUIREMENTS

5-5.201

- A. Signing and pavement marking design should be shown in the same plan view on the same plan sheet if practical.
- B. Plan sheets are to be complete and to scale, no smaller than 1 inch = 40 feet unless otherwise approved by the city Traffic Engineering Division.
- C. Entire length of project is to be shown in plan view. Typical Sections representative of striping and/or signing will not be accepted.
- D. Signing and pavement marking plans need to include all existing signing and pavement markings for a minimum of 300 feet past the limits of construction (except those devices that are to be removed) and include adequate transitions and tapers to existing pavement markings to maintain traffic at the design speed.
- E. The city requires a specific title and signature block to be placed in the lower right corner of each sheet, refer to Figure 5-4.4 Traffic Signal Approval Block. The consultant's title block is placed adjacent to the city block. The signature block includes the Transportation Director or designee.
- F. Rights-of-way lines are to be clearly identified.

SIGNING

5-5.202

- A. All signs should be graphically depicted in the direction of travel.
- B. All signs shall be stationed and referenced to the appropriate [MUTCD sign designation](#) with size noted.
- C. New and existing signs shall be visible to traffic for a value equal to 4 times the existing or proposed posted speed limit to provide adequate approach visibility.

- D. Existing or proposed speed limit should be posted to provide adequate approach visibility. Existing or proposed roadway improvements, vegetation or structures shall not block traffic sign visibility.
- E. All existing signs shall be identified to remain, be removed, or be relocated and shall be stationed and referenced to the appropriate [MUTCD sign designation](#).
- F. All existing advance or approach signing applicable to the project shall be field verified and referenced on the plan sheets, including location and/or station and proposed status of sign.

STRIPING

5-5.203

- A. All existing striping that is to remain shall be fully shown (as screened lines or lightly inked pen lines), identified by type and width, and completely dimensioned across roadway.
- B. Raised pavement markers shall be graphically shown in plan view and referenced by construction notation.
- C. All new striping shall be clearly identified noting color, line width, beginning station, ending station and intermediate stations at all directional changes.
- D. Striping to be removed needs to be identified as such on the plans.
- E. All striping shall be fully dimensioned across roadway and tied to a construction centerline or monument line at each side of an intersection.
- F. All pavement arrows, legends and crosswalks, etc., shall be located by station or dimension lines.

PLAN NOTES

5-5.204

These notes along with any additional project specific notes are to be placed on the lead signing and pavement marking plan sheet:

GENERAL NOTES BLOCK
<p>All pavement markings, signing and work zone traffic control type and layout need to conform to the latest edition of the Manual on Uniform Traffic Control Devices. Work zone traffic control needs to conform to the City of Phoenix Traffic Barricade Manual and/or as directed by the city Public Works Inspector or Traffic Engineering Division.</p> <p>Signs are to be installed on telespar prepunched square steel tubing posts per COS Standard Detail No. 2131.</p> <p>Dimensions to signs need to include the sign post, or in the case of multiple posts, the plan view center of the sign.</p> <p>“No Parking” signs shall only be used when the following site conditions exist. When any right-hand lane (curb lane) is 16 feet or wider, or if a paved shoulder area is present.</p> <p>Where on-street parking could be expected to occur, such as commercial areas where businesses have direct frontage on the street.</p> <p>When the above criteria exist “No Parking” signs (R8-3a 12-inch x 18 inch) with an arrow (single direction or bi-directional) below the “P” symbol on the sign to designate the direction of the restriction shall be installed approximately every 350-400 feet along the length of the project. No parking signs shall be installed approximately 5 feet from</p>

GENERAL NOTES BLOCK

the back of curb at a 45-degree angle to the curb. Street light poles should be used for sign mounting when a light pole is within 50 feet of the proposed sign location.

All longitudinal striping (edge line, lane line and centerline) shall be .090" (90 mil) extruded thermoplastic, unless otherwise noted on the plans.

All transverse striping (stop lines, crosswalk lines) shall be a minimum of .090" (90 mil) extruded thermoplastic, unless noted otherwise on the plans.

All plan view striping dimensions are measured to the center of the line or center of the double line.

All pavement symbols, arrows and legends shall be Type 1 permanent, high performance pre-formed pavement tape. (Tape must perform as 3M 380I-ES series or equivalent.)

RPMs shall be used on all striped streets. RPMs shall be installed per COS Standard Detail No. 2132 and ADOT Standard Drawing M-19, with a city approved bituminous adhesive.

Blue Type F (2-way reflective) RPMs shall be used to indicate the location of all fire hydrants and remote fire department connections, per COS Standard Detail No. 2363.

All existing pavement markings that conflict with proposed markings shall be removed by sandblasting, hydro blasting or grinding prior to the installation of new pavement markings. Treatment of pavement after striping has been removed, shall be a SS-1H or a product approved by the city Inspector.

ASTM Type XI Sheeting (minimum) shall be used for all warning and regulatory and street name signs. All advance street name signs shall be Type XI sheeting. School warning signs and accompanying placards must be ASTM Type XI fluorescent yellow green sheeting. All metro signs shall comply with the COS Standard Detail No. 2134-4 and 2134-3.

The contractor is responsible for layout of all pavement markings using control points spaced no more than 50 feet apart. Pavement marking layout shall be approved by Traffic Engineering prior to the application of the final product. All pavement marking drawings are schematic only. The contractor shall follow all dimensions, details and standards when installing pavement striping, marking and markers.

FIGURE 5-5.17 STANDARD PLANS SHEET NOTES BLOCK

Section 5-6

TRANSIT**5-6**

This section documents guidelines for Scottsdale’s public works projects and for developers working on projects that impact the fixed route transit system. This includes projects that create high-activity centers such as shopping malls or high-density living areas. Criteria are documented for locating fixed route bus service amenities such as bus stops, bus benches, bicycle racks, refuse containers and transit shelters. It includes street geometrics for bus bays, standard signage, submittal and review requirements, and a brief discussion on landscaping as it relates to fixed route transit amenities. The guidelines consider the needs of the user, bus operator, the general public, and neighbors adjacent to bus stops.

GENERAL INFORMATION

5-6.000

BUS STOP SPECIFICATIONS

5-6.001

Frequency of bus stops is dictated by the distance bus patrons are willing to walk to board a bus. The minimum standard for bus stop locations in Scottsdale is at 1/4-mile intervals for residential areas and 1/8-mile intervals for major activity centers.

To provide the greatest convenience and safety for passengers, bus stops are generally located as close to intersections as possible, refer to Figure 5-6.1. This minimizes walking distance for transferring passengers and encourages the use of crosswalks. Far-side stops, those located immediately past an intersection, are optimal for the following reasons:

- A. Minimal interference with traffic flow
- B. Minimal interference with intersection sight distance
- C. Less likelihood of passengers crossing in front of a bus
- D. Less conflict for automobile right turns
- E. Less obstruction for vehicles entering the intersection from a side street
- F. More effective bus re-entry into the traffic stream

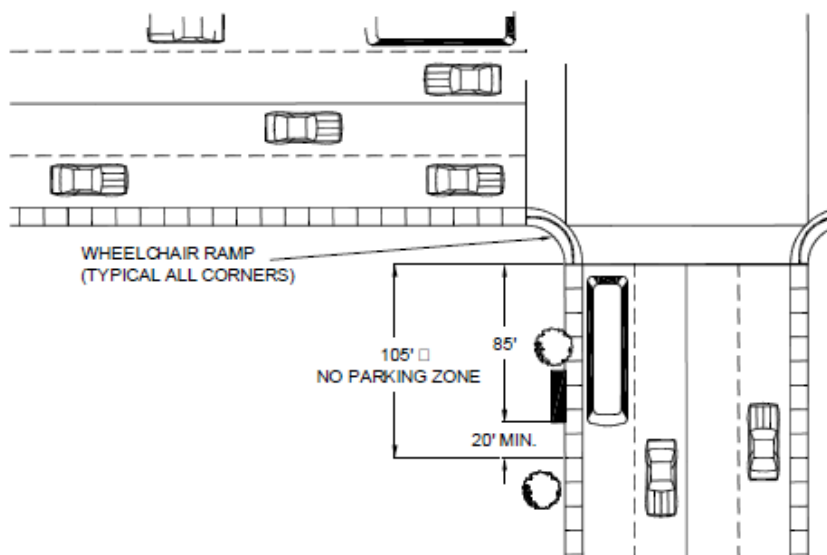

FIGURE 5-6.1 STANDARD BUS STOP LOCATION

The location of a bus stop is generally 85 feet, plus or minus 25 feet, from the curb of an unsignalized intersection, and 105 feet, plus or minus 25 feet, from a signalized intersection. In some circumstances, due to the location of major traffic generators, driveways, or unusual landscape issues, other locations can be submitted to the Transportation Department's Transit Manager for consideration and approval. Some circumstances are illustrated in Figure 5-6.2 and Figure 5-6.3.

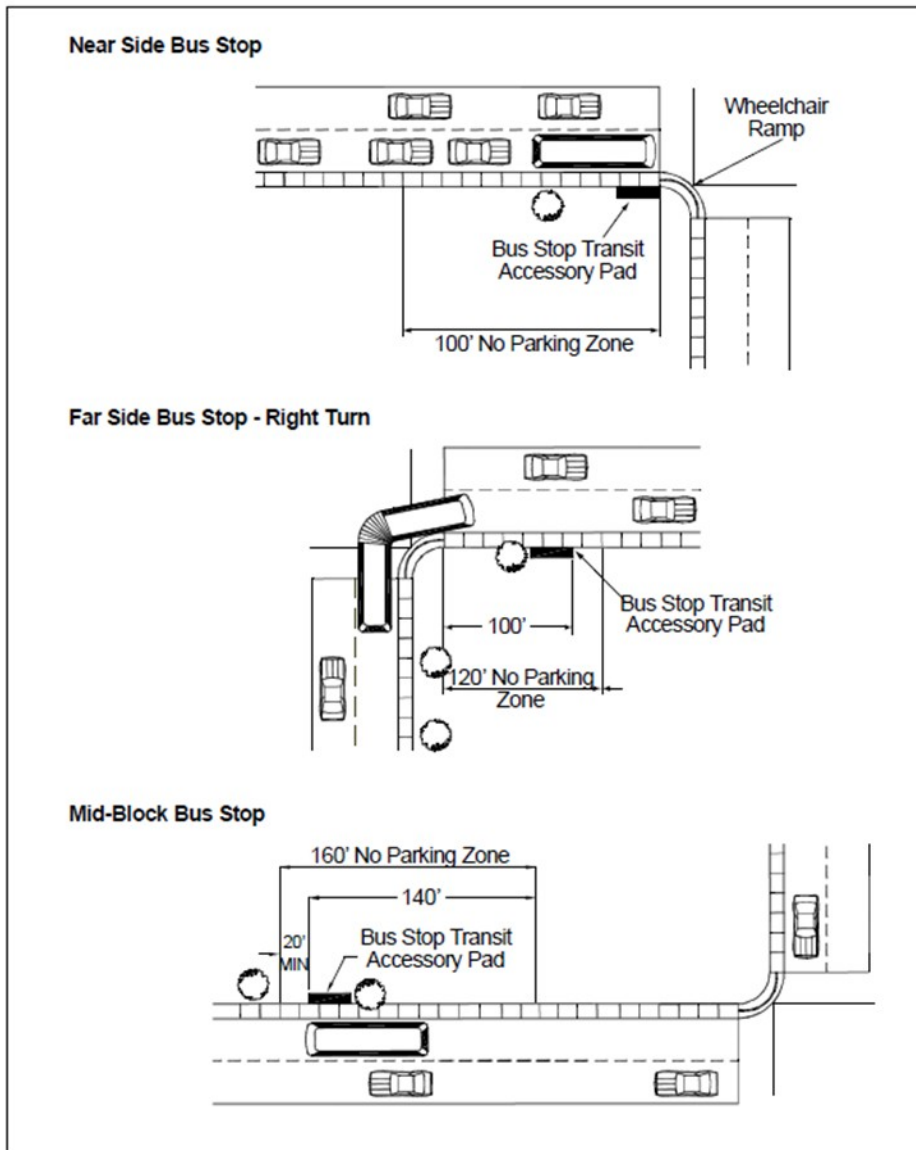

FIGURE 5-6.2 SPECIAL CONDITIONS BUS STOP LOCATIONS

Near side bus stops (those located immediately before an intersection) are considered when placement of far-side stops is not feasible or when that stop will be located near buildings with high volumes of transit riders. These types of stops may also be located where a high-volume bus transfer location would otherwise require a pedestrian crossing at a busy street.

On occasion, a mid-block bus stop may be utilized to provide access to a major generator, but it is generally discouraged due to the likelihood that pedestrians would cross streets mid-block rather than at intersections.

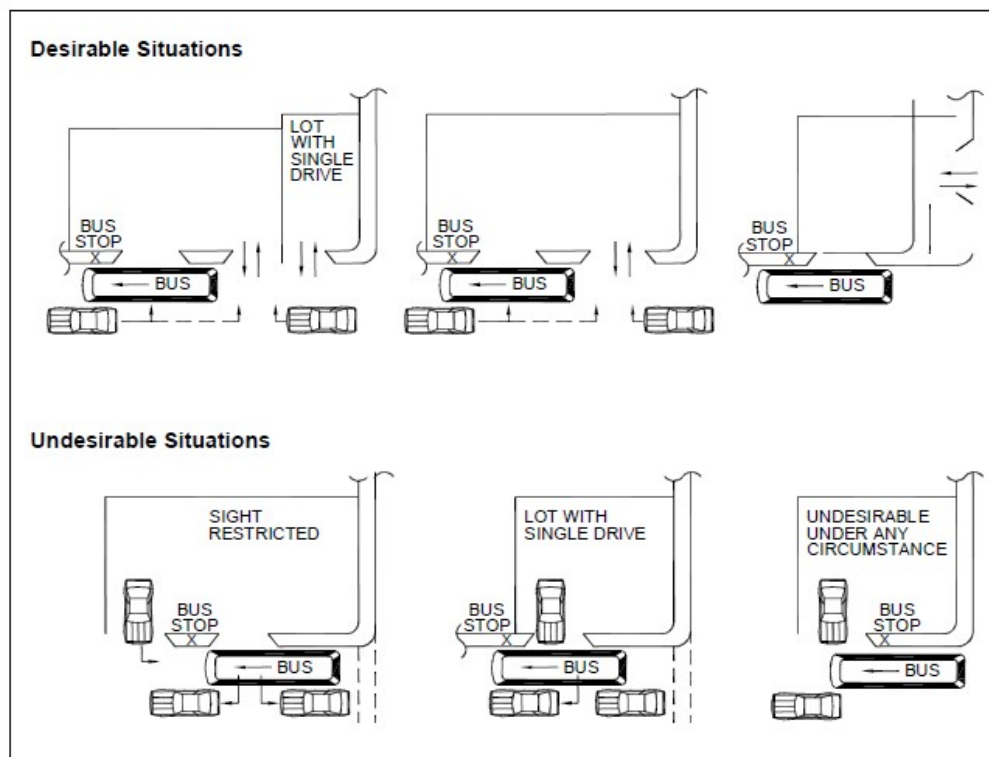

FIGURE 5-6.3 DRIVEWAY LOCATIONS NEAR BUS STOP

Where a development or subdivision is walled-off from the street, it is important to allow easy pedestrian access to the bus stop. This could include a pedestrian access path linking various sections of the development to the bus stop or a system of offset walls around development, which allow pedestrian passage.

ACCESSIBILITY

All transit facilities must comply with the applicable provisions of the ADA and associated guidelines, as updated, whenever technically feasible. At all bus stop locations where an accessible pedestrian route is available or where major improvements have been made to an existing inaccessible stop, the following elements shall be incorporated:

A. Surface:

Bus stop boarding, and alighting areas shall have a firm, stable and slip resistant surface.

B. Dimensions:

Bus stop boarding, and alighting areas shall provide a clear length of 96 inches (2440 mm) minimum, measured perpendicular to the curb or vehicle roadway edge, and a clear width of 60 inches (1525 mm) minimum, measured parallel to the vehicle roadway as shown in Figure 5-6.4

5-6.002

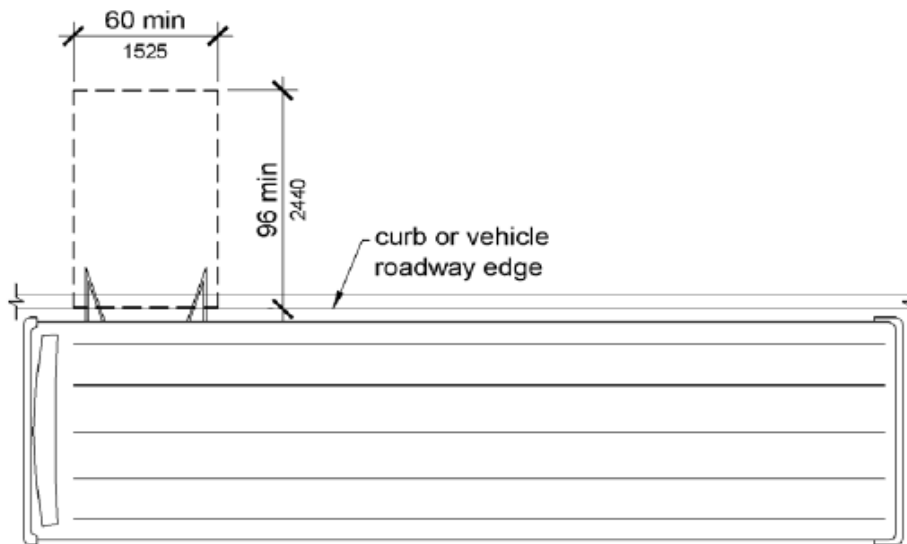

FIGURE 5-6.4 BUS STOP CLEARANCE ZONES

C. Connection:

Bus stop boarding, alighting areas and bus shelters shall be connected to streets, sidewalks or pedestrian paths by an unobstructed pedestrian access route at least 4 feet wide.

D. Grade:

Parallel to the street or highway, the grade of the bus stop boarding, and alighting area shall be the same as the street or highway, to the maximum extent practicable. Perpendicular to the street or highway, the grade of the bus stop boarding, and alighting area shall not be steeper than 2 percent.

E. Bus Shelters

Bus shelters shall have a minimum clear floor area of 30 inches (760 mm) by 48 inches (1220 mm), entirely within the perimeter of the shelter as shown in Figure 5-6.5. Such shelters shall be connected by an accessible route to the boarding area as stated in Section C – Connection as shown in Figure 5-6.6

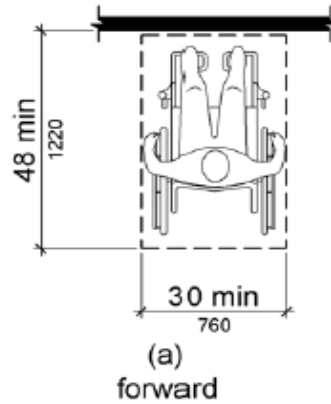

FIGURE 5-6.5 BUS SHELTER CLEARANCE ZONES

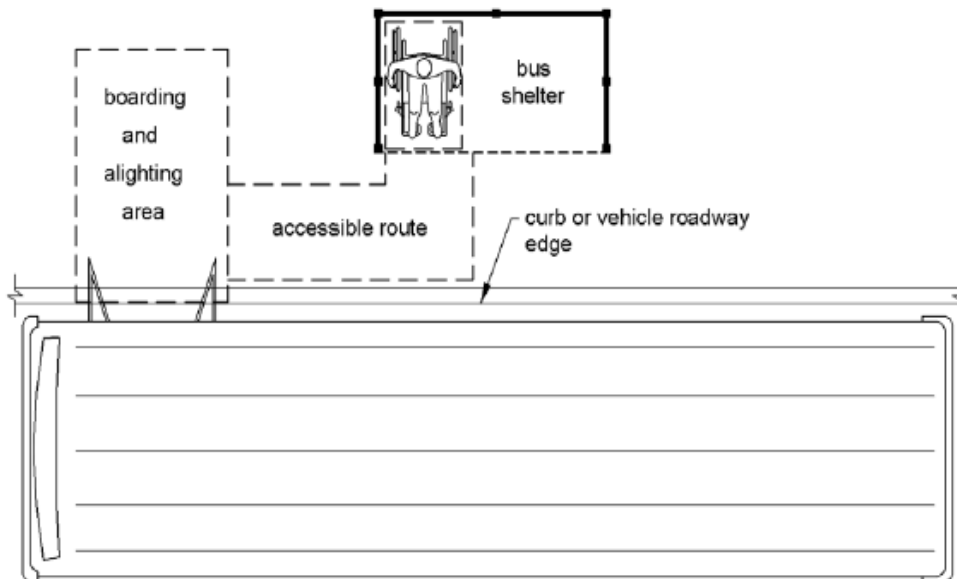

FIGURE 5-6.6 BUS SHELTER BOARDING AND ALIGHTING AREA

TRANSIT AMENITIES

5-6.100

Comfortable and secure passenger waiting areas should be provided at as many bus stops as feasible. The waiting areas may include a varying range of improvements depending upon ridership and specific site needs. All bus stop furniture must be placed outside the standard sidewalk. A minimum 4-foot clearance is required between transit components, fire hydrants, switch boxes and mail boxes, etc. Below are typical transit amenities and conditions under which they should be applied. Advertising and placards are not allowed.

Unique shelters, benches, trash receptacles and bike racks which reflect the architecture or surrounding urban form are sometimes used in Scottsdale and must be approved by the Transportation Department and/or the DRB.

The following paragraphs describe typical transit amenities and conditions under which they should be applied.

SHELTERS

5-6.101

The city strives to have a shelter provided at transfer points and other high-use stops. The city will continue to install additional shelters afforded by budgetary and other such restraints. In a development, city staff may waive any requirement for passenger shelters if there is adequate exterior shading and architectural shelter. Shelters should be arranged with consideration to the sun’s angles. Coverage should allow for maximum shade during the peak use hours of the summer morning and afternoon.

However, the shelter should also be oriented to allow the bus driver clear visibility of the passengers and to allow passengers a view of oncoming traffic.

Scottsdale has standard design criteria that must be met for all bus shelter locations. The dimensions of the bus stop and the minimum for a Bus Stop Easement are 11 x 28 feet; this allows a 2-foot working area around the shelter. A typical foundation used for all shelters is shown in Figure 5-6.7. Refer to [COS Standard Detail](#) 2263-1.

Contractors must provide shop drawings of shelter designs as well as the location of the shelter to the Transportation Department’s Transit Manager before construction.

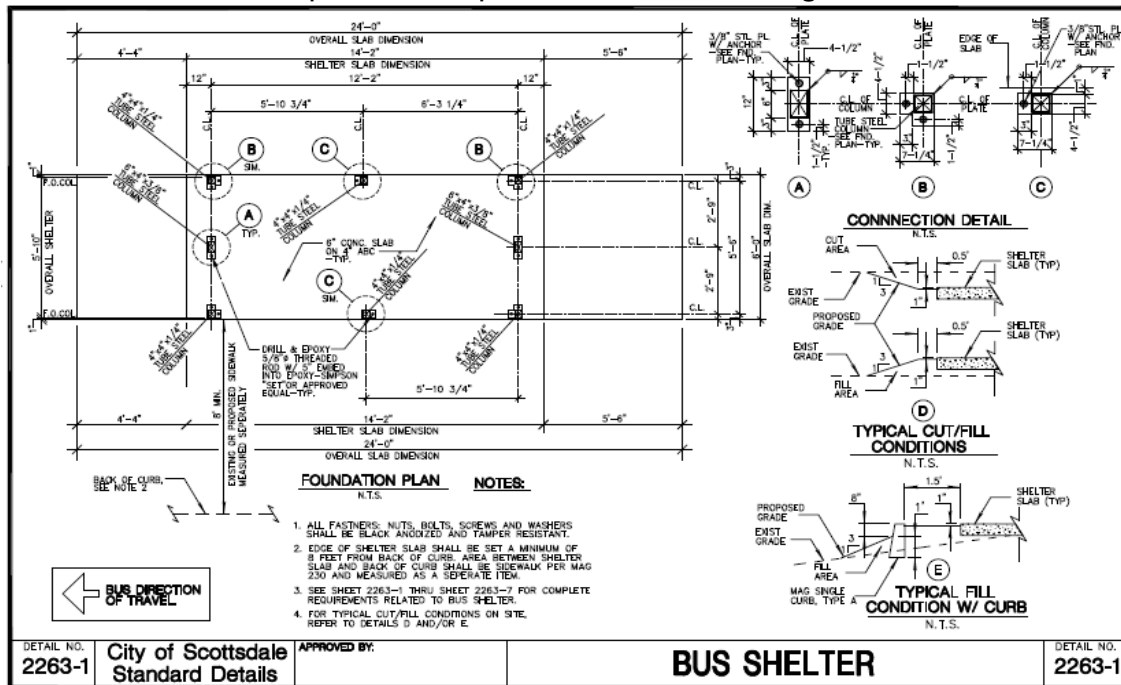

FIGURE 5-6.7 BUS SHELTER FOUNDATION PLAN

A. Shelter design must meet the following criteria:

1. Minimum canopy of 65 square feet with a minimum width of 5.5 feet
2. Minimum 7-foot clearance between underside of roof and sidewalk surface
3. Waterproofed shelter canopy with provisions for drainage away from transit users
4. Shaded seating areas
5. Sight distance into and out of the shelter

6. Minimum 6 inches of vertical clearance from the sidewalk to avoid trash and debris collection
 7. Fixed components to prevent unauthorized removal
 8. Materials that allow for air circulation and avoid hot air containment
 9. Materials finished to prevent overheating
 10. Insulated canopy materials that collect and radiate heat
 11. Materials, coatings and surfaces that are graffiti-resistant
 12. Components of the shelter that are readily replaceable
 13. Colors appropriate to the architectural character of the development and the transit system (per review and approval of DRB)
 14. Minimum 2-foot clearance between roof canopy and face of curb
 15. Arrangement of furniture that allows a 3-foot by 4-foot barrier-free access for wheelchair users.
 16. Minimum 4-foot-wide unobstructed pedestrian accessible route path into the shelter and connecting to streets, sidewalks or other pedestrian paths
- B. The city has two shelter designs:**
1. Standard Shelter: Refer to [COS Standard Details](#) 2263-1 through 2263-7.
 2. Scottsdale Road Streetscape Shelter. Refer to [COS Standard Details](#) 2264-1 through 2264-11.
 3. These shelters consist of varying design elements.
 - a. Standard Shelter

The most common type of shelter in Scottsdale is the Standard Shelter, known as the Double L configuration. Refer to Figure 5-6.8 and [COS Standard Detail](#) No. 2263.



FIGURE 5-6.8 STANDARD SHELTER “DOUBLE L” CONFIGURATION

- b. Scottsdale Road Streetscape Shelter

The Scottsdale Road Streetscape Shelter is only applicable to Scottsdale Road and is intended to maintain a strong identity and character of

Scottsdale Road (refer to Standard Detail No. 2264). Figure 5-6.9 provides a photo of a Scottsdale Road Streetscape Shelter.



FIGURE 5-6.9 SCOTTSDALE ROAD STREETSCAPE SHELTER

FURNITURE

5-6.102

A. Standard Benches

The desire of the city is to have benches at all bus stops. Several styles of benches have been approved for placement in Scottsdale depending on location. Specialty benches which reflect the architecture of the built environment are sometimes used in downtown Scottsdale but must be approved by the Transportation Department.

Base slab and foundations for bus stop benches and receptacles must follow city standards. Refer to [COS Standard Detail](#) No. 2268 for slab requirements. All standardized benches, other than specialty benches, must be Landscapeforms® Plexus II, bronze powder coat with anti-graffiti coating. All stops must include a three-seat bench, two-seat bench, and single-seat bench. A standardized bench is used in all locations except for those bus stops affected by the ESL area. Interested parties may contact the Transportation Department for the most recently approved standard. Transit amenities located within ESL area boundaries must conform to its [guidelines](#).

Additional styles may be acceptable but require city staff approval and may need DRB approval.

Design of benches shall have backrests for support and spacers between the seats to discourage people from lying on the seats. Seats should be 17 to 19 inches above finished floor. A minimum of 6 linear feet of seating should be used. More seating is required at high-use stops. Please contact the Transportation Department to determine if a location is a high-use stop.

B. Simme-Seat Benches

[Simme-Seats](#) are two small metal mesh jump seats attached to the bus stop pole (refer to Figure 5-6.10). Simme-Seats are used with limited space options or smaller right-of-way areas to provide seating when there is not enough space for a

standard bench. Simme-Seats must have a bronze powder coat with anti-graffiti coating.



FIGURE 5-6.10 SIMME-SEATS

C. Other Furniture

All locations except those bus stops in the ESL area shall have a Landscapeforms® Plexus matching trash receptacle (minimum capacity of 28 gallons, side opening with ash tray) and a minimum of two vertical bike loops to be installed per [COS Standard Detail](#) No. 2285. Scottsdale Road Streetscape Shelter bicycle racks must be Landscapeforms® Flo-surface mounts.

BUS BAYS (PULLOUTS)

Bus bays enable buses to pull completely out of the traffic lane while loading and unloading passengers. Bus bays are recommended under the following conditions:

- A. At or near transfer points,
- B. When average peak period dwell time exceeds 30 seconds per bus.

Two types of bus bays are allowed: open-ended and closed (refer to Figure 5-6.11). Closed bus bays are the preferred option. Generally, open-ended bays are used on far-side stops where space is limited. Refer to [COS Standard Details](#) 2266-1, 2266-2 and 2267 for specific dimensions.

5-6.103

Closed (Preferred)

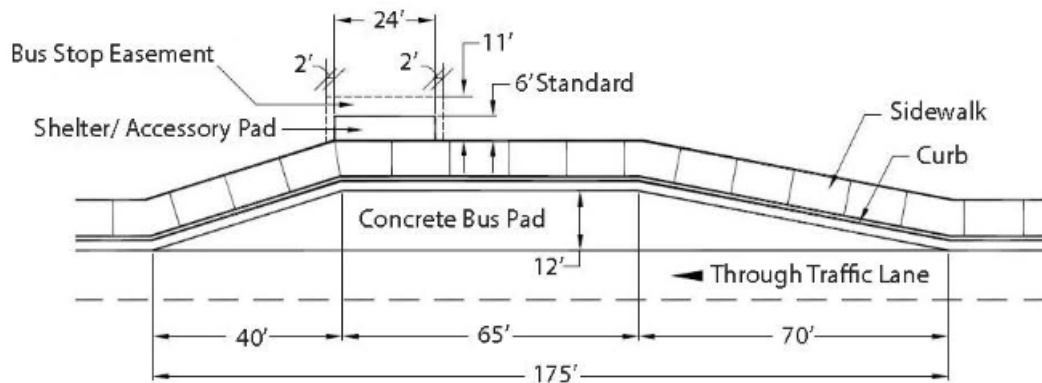

Open Ended

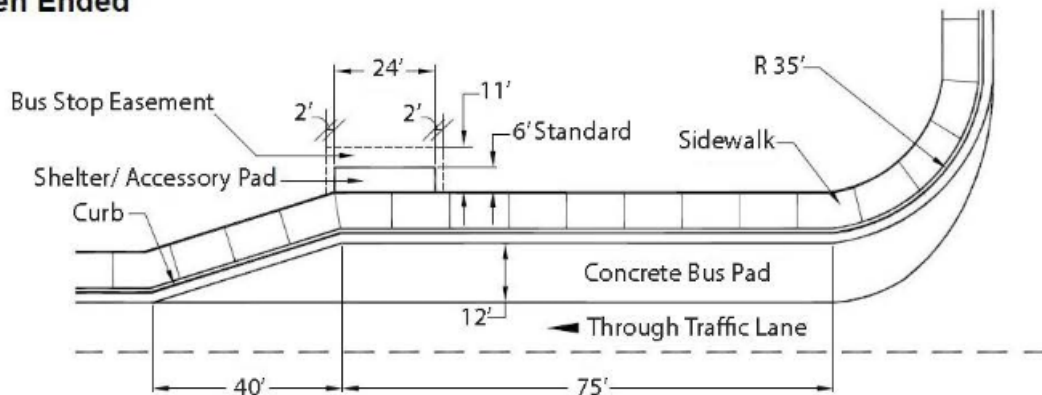

FIGURE 5-6.11 BUS BAYS

LANDSCAPING

5-6.200

Wherever possible provide shade trees and other protective landscaping. This landscaping could be considered part of the frontage landscape area for a development and could count towards any landscaping requirements that may apply. Considerations for selection and location of landscaping include:

- A. Trees should be mature and have an adequate canopy to shade the seating area.
 - B. Low-water consumption trees and shrubs should be used.
 - C. Tree location should consider the solar orientation of the bus stop. Priority should be given to shading from the afternoon summer sun.
 - D. Transit landscaping should be compatible with other frontage landscaping.
- Carefully locate all landscaping needs, so they do not obstruct the visibility of either the transit user or the bus operator. The developer/property owner is responsible for the maintenance of landscaping at bus stops.

SIGNAGE

5-6.300

BUS STOP SIGNS

5-6.301

A bus stop sign is an important passenger convenience and an operations and marketing tool for transit systems. It serves as a reference for passengers, bus operators, and as a point of identity for the transit system.

The bus stop sign is generally not a traffic sign other than the sign contains “No Parking” information for motorists approaching the bus stop.

A regional bus stop sign is currently in use throughout the Valley (refer to Figure 5-6.12). The sign is 18 inches wide x 24 inches high, reflectorized for nighttime visibility and is double-faced so that it can be seen from both directions. The upstream side of the

The standard regional sign identifies a location as a bus stop, includes the name and number of the bus route(s) being served and displays the transit information telephone number. Stops that are included in the NextRide automated system will have a sign that provides the NextRide STOP# (refer to Figure 5-6.13).

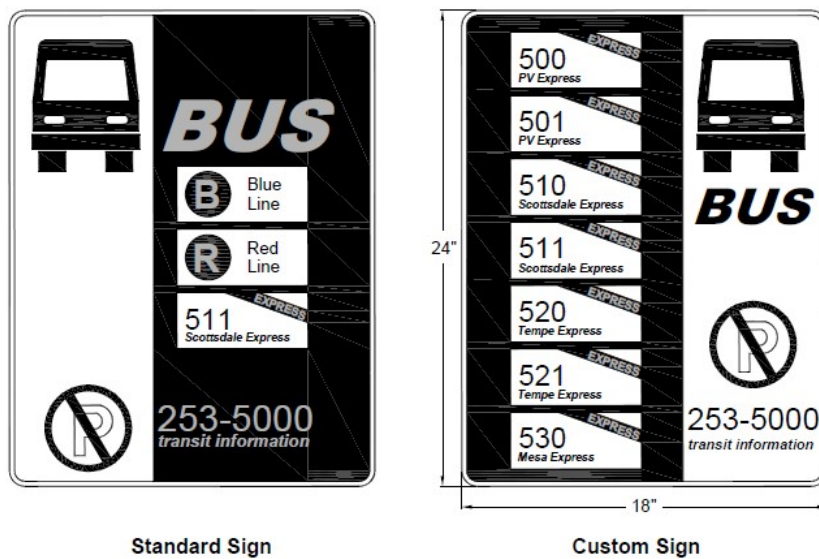

FIGURE 5-6.12 BUS STOP SIGNS



FIGURE 5-6.13 BUS NEXTRIDE SIGN

SIGN PLACEMENT

5-6.302

Bus stop signs must be placed at the location where people board at the front door of the bus. In cases where the bus stop sign is incorporated into the design of a TS, the need for a separate sign may be eliminated.

Ideally, bus stop signs should be placed independently of all other signs to maintain the importance of the bus stop identity. Each sign should be installed with its own signpost, although non-wood light poles may be used if it is at the proper stop location and if the sign face is visible from both sides. Do not place signs on wood poles as it poses a hazard to linemen who climb the poles.

Bus stop signs should be installed on signposts or metal poles so that the sign is “flagged.” In other words, the sign should be attached to the post by its edge. This allows both sides of the sign to be viewed without obstruction. The bottom of the sign should be 7 feet above ground level, at least 2 feet from the curb face, and away from obstructions such as landscaping or other signs. The standard regional sign has been designed so that it may be mounted by its edge to a 2-inch post without obscuring the backside message. Where metal street light poles are at the proper location but too close to the curb, the signs may be flagged away from the street (refer to Figure 5-6.14).

Usually, the city will be responsible for the installation of bus stop signs. For more information, contact the Transportation Department.

SIGN CLEARANCES

5-6.303

Sign clearance dimensions vary by sidewalk / curb relationships, as shown in Figure 5-6.14.

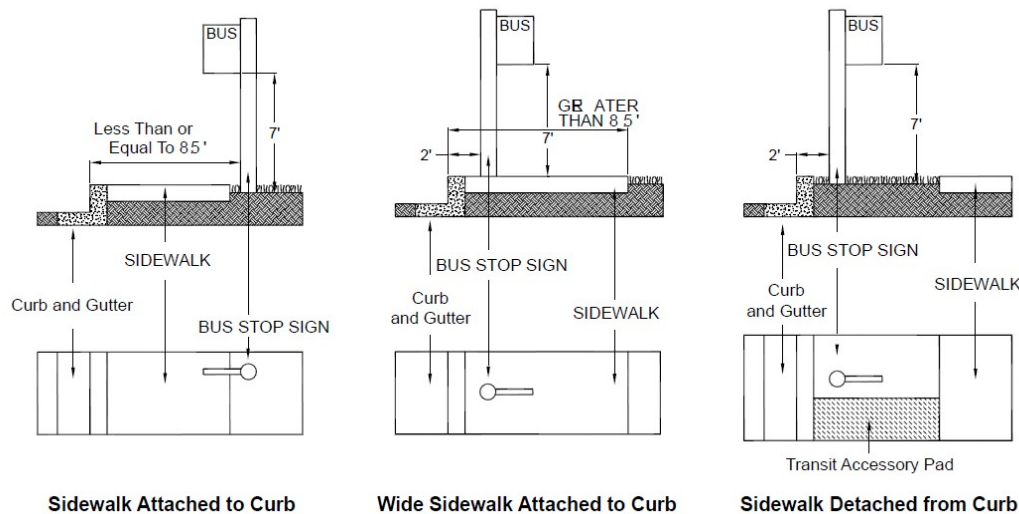

FIGURE 5-6.14 BUS STOP SIGN CLEARANCES

OTHER FACILITIES

5-6.304

Other facilities, such as park-and-ride lots or transfers centers, may be planned at special locations, usually high activity centers or a focal point of several transit routes. These facilities are unique and must be planned through discussion and negotiation between the city's Transportation Department and the developer and/or adjacent property owners/users. In general, the same criteria (as well as transit industry standards) apply for turning radii, passenger loading platforms and parking space requirements, etc.

SUBMITTAL REQUIREMENTS AND REVIEW PROCESS

5-6.305

The following facilities must be delineated on any site plan or preliminary plat submitted to the city:

- A. Bus bays
- B. Bus stops
- C. Shelter sites
- D. Major transfer centers
- E. Park-and-ride lots

Transit staff must approve the design and location of the above facilities during the project review process. Bus stop easements need to be completed during the project review process.

Developers may deposit funds in lieu of construction and installation of stipulated transit amenities. The amounts of funds to be deposited are determined during the project review process and are in force upon City Council approval of the project.

Section 5-7

BIKEWAYS

5-7

This section provides design criteria for bicycle and multiuse paths within the city. It presents information for planning, facility design, traffic controls, bicycle parking, and bikeway maintenance.

GENERAL INFORMATION

5-7.000

COMPONENTS OF BIKEWAY SYSTEM

5-7.001

A. **Bike Lanes**

Bike lanes are integral sections of a roadway that are marked for exclusive bicycle use and are always one-way.

B. **Bike Routes**

Bike routes may include shared streets, bike lanes or shared-use or multiuse paths, in any combination. Routes may be designated by signing or by placement on a map.

C. **Grade-Separated Crossings**

Crossings are underpasses or overpasses that serve to isolate motorized and non-motorized traffic from each other at points of intersections.

D. **Shared-Use or Multiuse Paths**

Shared-use or multiuse paths are paved pathways set aside for the exclusive use of non-motorized travel and are generally intended for 2-way traffic. Paths are typically separate from the road infrastructure.

E. **Shared-Use or Multiuse Trails**

Shared-Use or multiuse trails are unpaved and designed to accommodate equestrians, pedestrians and bicyclists. Refer to Section 8-3 for trail information.

F. **Shared Streets**

Shared streets are all streets that do not have bike lanes where bicycles and motor vehicles share the same roadway. This includes all public streets except those specifically posted to prohibit bicycles.

DOCUMENTS AND REFERENCES

5-7.002

The following publications or their current revisions are to be used in conjunction with the design criteria in this manual when designing bicycle or shared-use or multiuse paths for the city:

- A. American Association of State Highway and Transportation Officials (AASHTO) Guide for the Development of Bicycle Facilities, 2012.
- B. City of Scottsdale Transportation Master Plan, 2016.
- C. COS Community Mobility Element of the General Plan, 2001.
- D. COS Zoning Ordinance, Article IX.
- E. MUTCD Section IX, Traffic Controls for Bicycle Facilities.
- F. MAG Regional Bicycle Plan, 1999.
- G. MAG Regional Off-Street System Plan (ROSS), 2001.
- H. MAG Uniform Standard Specifications for Public Works Construction.
- I. COS Supplement to MAG Uniform Standard Specifications for Public Works Construction.
- J. National Association of City Transportation Officials (NACTO) Urban Bikeway Design Guide (2011).

PLANNING BIKEWAY SYSTEM

5-7.100

LOCATIONS

5-7.101

It is a goal of the Scottsdale bikeway system to provide facilities on a minimum of a:

- A. Half-mile grid south of Shea Boulevard.
- B. One-mile grid between Shea Blvd. and the Central Arizona Project (CAP) Canal.
- C. Two-mile grid north of the CAP Canal.

Providing equal grids for both on- and off-street types of bikeways is encouraged, as it will accommodate the widest possible range of users, purposes and trip destinations.

The COS Transportation Master Plan (2016) contains maps of existing on-street and off-street bikeways as well as planned off-street bikeways.

FACILITY SELECTION: ON-STREET

5-7.102

Bike lanes are the most desirable facility for any street with a classification of minor collector or higher. For these streets with higher volumes of traffic, the classification of a street will determine its cross-section; refer to Section 5-3.100. Major arterials, minor arterials, major collectors, minor collectors and certain special neighborhood and rural streets have standard cross-sections that include bicycle lanes. Bike lanes would, therefore, be included on these streets whenever they are built or reconstructed.

For streets that provide a connection for local or regional bikeway systems, but where a full cross-section with bicycle lanes cannot be accommodated, the following measures should be considered, in order of desirability:

- A. Edge line stripe with route signs
- B. Edge line stripe with no signs
- C. Route signs with no edge stripe

FACILITY SELECTION: OFF-STREET

5-7.103

In planning for off-street shared-use or multiuse paths, the following hierarchy should apply, starting with the most desirable:

- A. Ten- or 12-foot-wide shared-use or multiuse path well separated from streets and in a natural setting.
- B. Ten- or 12-foot-wide pathway set off from the street by at least 10 feet of landscaping.
- C. Ten- or 12-foot-wide shared-use or multiuse path protected from the street with a traffic barrier and railing.

Connections between different types of facilities are very important to ensure an efficient and functional system. In places, shared-use or multiuse paths may be used to connect sections of roadways that would otherwise dead-end. However, it is critical not to attempt to substitute a path or a sidewalk where bike lanes are warranted. Bike lanes allow direct, higher-speed travel for cyclists, unimpeded by pedestrians. Bike lanes are also one-way, going with the adjacent traffic. Since paths are typically two-way, designing a path to connect with bike lanes and not have cyclists riding the wrong way (against traffic) in one of the bike lanes requires very careful study and design.

Opportunities to provide bicycle access may occur in conjunction with public or private development, greenbelts, canal banks, flood control projects, vista corridors or any place with available open space or rights-of-way. It is the intention of Scottsdale's bicycle planning efforts to remain flexible and open to new opportunities.

EASEMENTS, DEDICATIONS AND ABANDONMENTS

5-7.104

In the case of on-street facilities, the bike lane or route is typically located within the street rights-of-way (ROW). Sometimes on-street facilities may need to be connected with short sections of paved path. An example of this would be cul-de-sacs that have only one direct access to the public street system. Sometimes the cul-de-sac street can be connected to allow bicycle and foot access to reach adjacent streets, paths, trails or property.

If a private, gated community will cut off functional access for cyclists, means should be explored to maintain a public use easement, on the streets and through the gates, for pedestrians and cyclists.

For off-street paths, the applicant may obtain a ROW through development stipulations or purchase. Any easements or dedications for paths should include a clear statement of maintenance responsibilities for (1) the actual concrete path, (2) any adjacent landscaping or lighting and (3) for maintaining proper grades and drainage along the path. Dedication of rights-of-way or public use easements for paths must be noted in the stipulations and on the site plan. This should occur in the Project Review process for new developments.

If the applicant proposes changing the classification of an existing/planned street or abandonment of a street easement or ROW, current and potential pedestrian and cyclist connections shall be reviewed, refer to Chapter 3 of this manual. The proposed changes will be evaluated against the needs of the bicycle program. If needed, some means of bicycle and/or foot access such as a public use easement should be obtained.

FACILITY DESIGNS

5-7.200

While every effort has been made to ensure the accuracy and completeness of these guidelines, the city shall not be held responsible for any errors or omissions. It shall be the sole responsibility of the design engineer to ensure a proper design and the accuracy and completeness of construction documents containing his or her signature.

Any substitutions or exceptions must provide the same functions and be approved by the Transportation Department.

SHARED STREETS AND BIKE ROUTES

5-7.201

It is assumed that cyclists will ride on all streets, unless such use is expressly prohibited and posted. Many neighborhood streets function quite well as bikeways with no additional signing or marking. If these streets are needed to complete some part of the bikeway system or to provide a connection for cyclists, the street may be designated by edge stripes, signs or on a map.

Since cyclists will tend to use the right side of the outside lane, this area should always be built and maintained to accommodate that use. Drainage grates should be designed and installed in a manner that will not trap wheels. Longitudinal cracks, potholes, rough paving, etc., should be eliminated.

BIKE LANES

5-7.202

Streets such as major arterials, minor arterials, major collectors, minor collectors and certain neighborhood and rural streets have cross-sections that include bicycle lanes. These cross-sections are in Section 5-3.100.

A. General

1. The recommended minimum width of a bike lane is 5-feet from the face of the curb. A minimum of 4 feet of asphalt is preferred. A minimum of 3 feet of asphalt is acceptable with approval of the Traffic Engineering Director. A solid 8-inch white stripe will be used between the bike lane and travel lane unless directed to be 4-inches wide by the Transportation Director. An alternative method is to combine the lane and gutter pan as one concrete strip. In these cases, it is desirable to exceed the 4-foot minimum as measured to the face of the vertical curb. Refer to Figure 5-7.1 through Figure 5-7.4.
2. Any grade separation structure should allow the full width of the physical improvements, including standard bike lanes. Also note that most surface streets, even without designated bike lanes or shoulders, usually allow for some "shy distance" or permit an emergency move off the road. Bridges and underpasses with solid barriers alongside often become dangerous constriction points for bicycle travel. Therefore, consideration should be given to maintaining extra width on bridges and in tunnels even if the street does not have bike lanes.
3. In rural areas, a paved shoulder can serve the function of a bike lane, in which case it should have a minimum of 5 feet of paving. A bicycle lane can also be delineated with striping between an area for parallel parking and a traffic lane. In this case the bicycle lane should be at least 5 feet, refer to Figure 5-7.3.
4. Whenever a half-street is constructed, if the ultimate street classification has a cross-section with bike lanes, then the half-street construction should also provide a bike lane on each side.
5. Parking is not permitted in marked bicycle lanes.
6. Raised pavement markers or curbing should never be used to delineate bike lanes.
7. Figure 5-7.1 through Figure 5-7.4 gives examples of bike lane configurations for various situations. These cross sections are compatible with Section 5-3., Geometrics.
8. Refer to Signs and Markings Section 5-5.102 for striping detail.
9. For additional information concerning bike lanes and routes not covered in this manual, please refer to the AASHTO Guide for the Development of Bicycle Facilities, 2012.

B. Curbed Street Where Parking is Prohibited

4-foot lane is exclusive of curb and gutter.

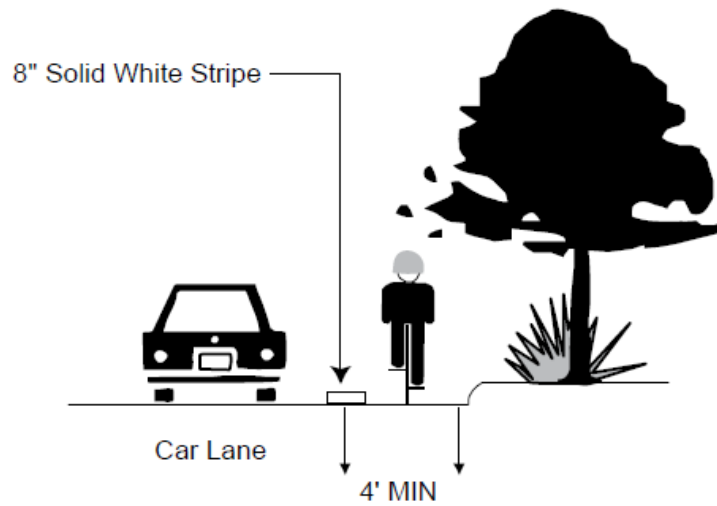

FIGURE 5-7.1 BIKE LANE WHERE PARKING IS PROHIBITED

C. Wide Curb Lanes

Monolithic concrete curb, gutter and bike lane. No longitudinal joints.

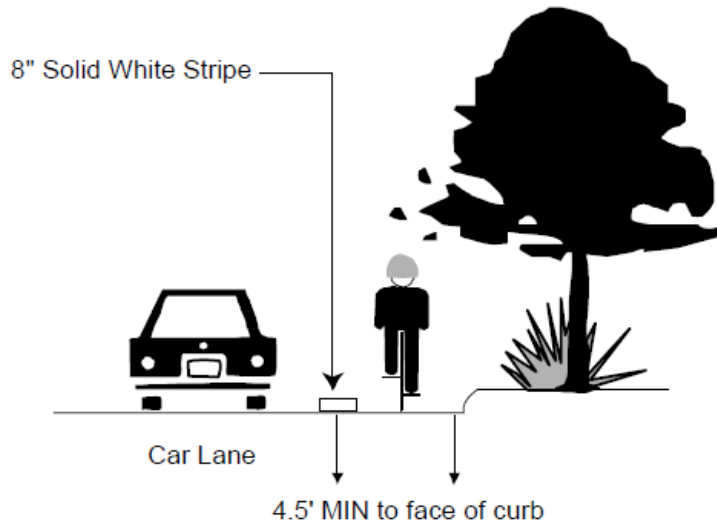

FIGURE 5-7.2 BIKE LANE WITH WIDE CURB LANES

D. Street with Paved Shoulder

Curb and gutter is not present. Shoulder functions as bike lane.

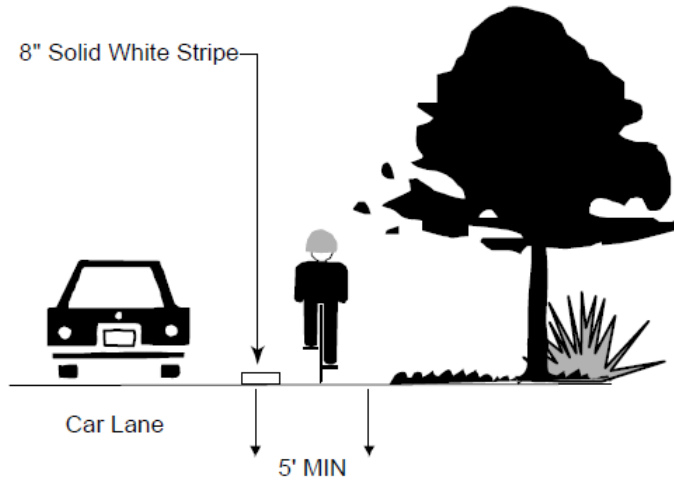

FIGURE 5-7.3 BIKE LANE ON PAVED SHOULDER

E. Curbed Street with Parking

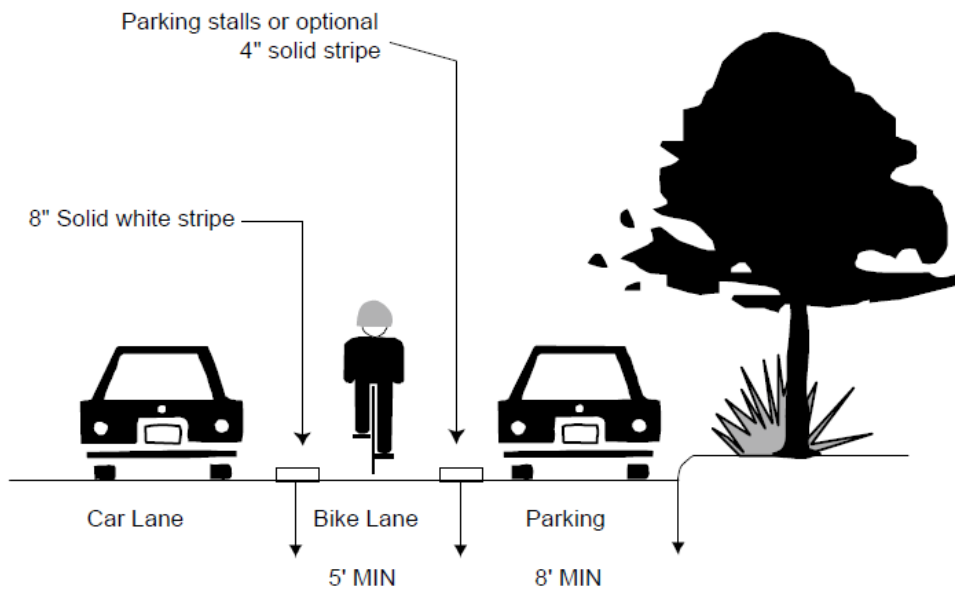

FIGURE 5-7.4 BIKE LANE WITH PARKING

SHARED USE OR MULTIUSE PATHS

5-7.203

A. General

1. Operation and use of shared-use or multiuse paths are covered by COS Revised Code, Article IV, Chapter 17.
2. [COS Standard Detail](#) Nos. 2281 - 2285 for shared-use or multiuse paths.

3. Placement of a shared-use or multiuse path may correspond/overlap with a trail underpass. Contact the Transportation Department to verify path or trail underpass locations and design standards.
4. For additional information not covered in this manual, please refer to the AASHTO Guide for the Development of Bicycle Facilities, 2012. That guide provides technical information on minimum radii for curves, grades, sight distances and stopping sight distances under various conditions.

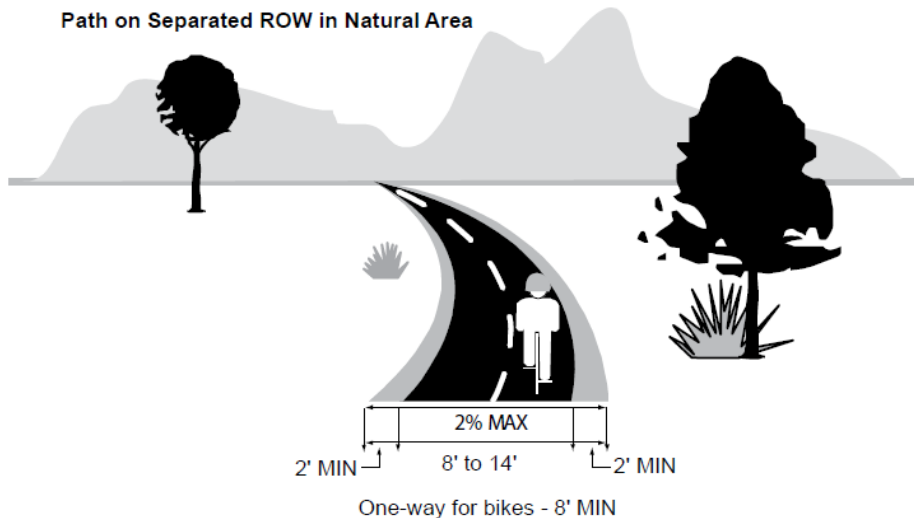

Path Separate but Near Roadway

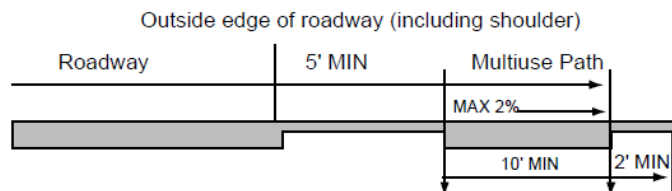

Path Next to Roadway

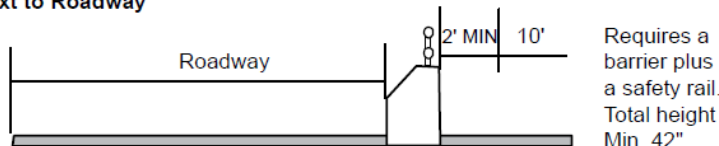

FIGURE 5-7.5 SHARED-USE OR MULTIUSE PATH PERSPECTIVES

B. Shared-Use or Multiuse Path Requirements

1. The path should have a minimum design speed of 20 mph.
2. The path should have a typical width of 10 feet with a 2-foot-wide shoulder on each side.
3. There should be a width of 8 feet where paths can be paired so each path direction can have 1-way travel, plus 2-foot-wide shoulders.
4. There should be a width of 12 feet where heavy use is expected, especially with a high percentage of pedestrians/skaters.

5. There should be a medium broom finish on the surface. It is desirable to provide traction, but not to a degree that impedes skaters. If a section of paved path will include equestrian use, a rough broom finish or approved non-slip epoxy is required if an adjacent unpaved trail is not provided.
6. There should be material for the shoulders that can allow for recovery if a user runs off the path. Substances such as turf, decomposed granite, exposed aggregate or various ground covers are appropriate. No spiny/thorny plants.
7. Landscaping beyond the 2-foot-wide shoulders shall not consist of vegetation that are spiny/thorny or that have horizontal growth patterns which could encroach onto the path.
8. Irrigation systems will be installed in a manner that will not result in water spraying onto or across the path.
9. The area should be clear of fixed objects such as poles or tree trunks for another 3 feet beyond the shoulder.
10. Handrails for paths or bikeways should be minimum 42 inches in height and be flared at the ends.
11. There should be a vertical clearance of 8 feet over the path and shoulder areas, refer to Figure 5-7.9.
12. Vertical clearance in tunnels should be 10 feet whenever possible, refer to Figure 5-7.11.
13. Grades should be 5 percent or less. Where this is not feasible, refer to the AASHTO Guidelines. The Transportation Department will make the final decision. Maximum side slope is 2 percent.
14. Alignment should be as linear as possible; avoid compound curves, refer to Figure 5-7.6. Excessive meandering reduces the effective width of the path and can create sight distance problems which may increase the possibility of users running off the path.
15. Adjacent grades should always direct water away from the path surface, such as using a small swale on the up-slope side.
16. Underpasses shall be designed to keep nuisance water off the path and allow the water to rapidly drain or be removed. One solution is a small channel constructed with a sloping side, built on one side of the tunnel. Sump pumps are needed in areas prone to flooding. Refer to Figure 5-7.11 and Figure 5-7.12.
17. Underpasses should be lighted.
18. Path ramp design requires that the pan for any curb ramp shall be as wide as the path. The ramp should be aligned with the path and not require users to make sudden swerves or to be directed towards oncoming traffic. Refer to COS Standard Details.
19. Signage providing general location information should be located at a minimum of 1/4 mile interval. Placement of these signs should be on or adjacent to the path. Contact the Transportation Department for specifics.

Paths shall be constructed to be as linear as possible.
Avoid compound curves.

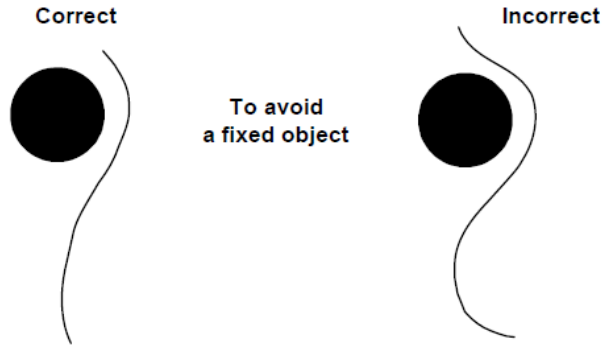
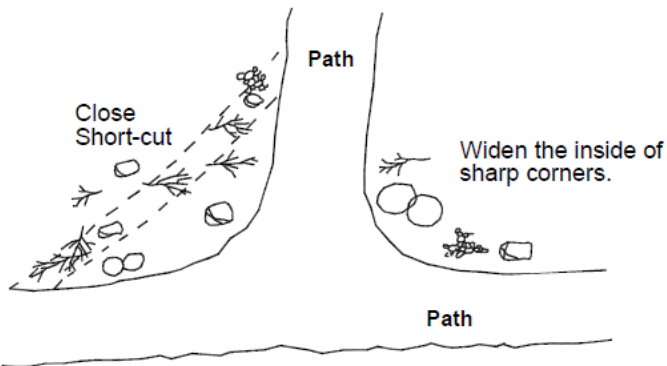
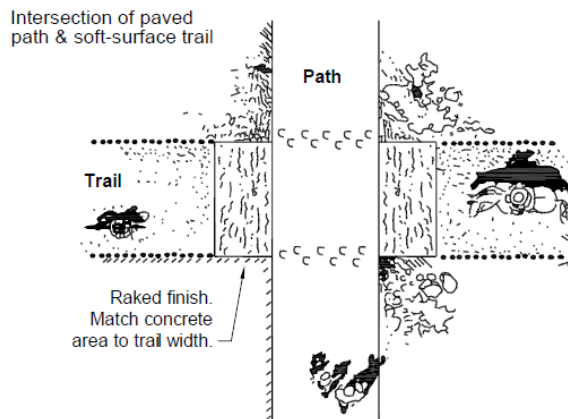

FIGURE 5-7.6 AVOIDING FIXED OBJECTS



Use proper signage and wider inside curves.
Maintain landscape for sight distance.

FIGURE 5-7.7 PATH – PATH INTERSECTIONS



Use a concrete transition between trail and path to prevent dirt drag-out.

FIGURE 5-7.8 PATH – TRAIL INTERSECTIONS

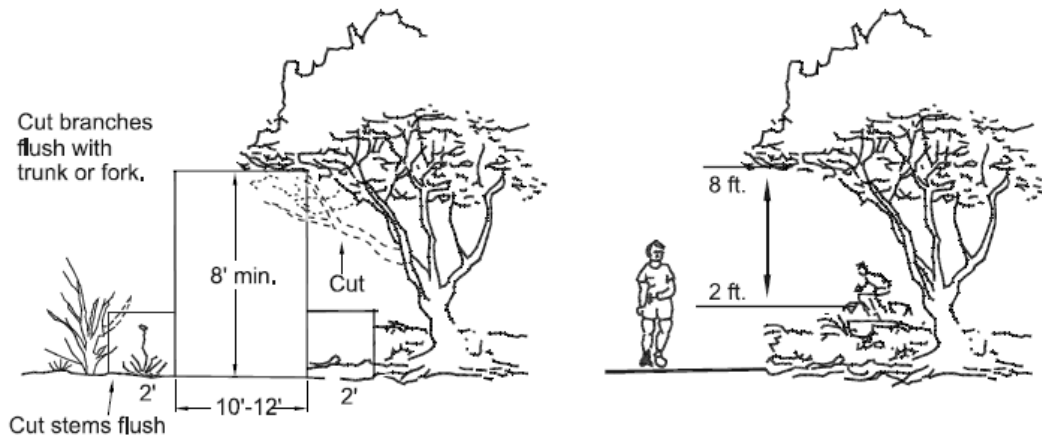

FIGURE 5-7.9 PATH VEGETATION CLEARANCE

C. Other Special Conditions

Every attempt should be made to avoid having a shared-use or multiuse path directly adjacent to a street. If this is unavoidable, try to achieve a separation of at least 5 feet, with landscaping. If the path and street separation will be less than 5 feet, then a combination vehicular and bicycle railing and traffic barrier should be used. The top of the barrier and rail must be at least 42 inches. These railings perform the dual function of retaining both vehicles in the street and cyclists on the path; refer to Figure 5-7.5. For path/street intersections, use grade-separated crossings (either over or underpasses) where feasible.

Most of these crossings will be at-grade. However, certain design practices can greatly improve these at-grade crossings, whether they are mid-block, controlled intersections or driveway exits. Some practices found helpful in Scottsdale include making crossings of contrasting material, striping each side of the crossing, restricting median bullnoses from the path or elevating the path on a speed table. Refer to Figure 5-7.6, through Figure 5-7.8 and Figure 5-7.12 and [COS Standard Detail](#) No. 2281.

Approach to Overpass

See design standards for appropriate upgrades.

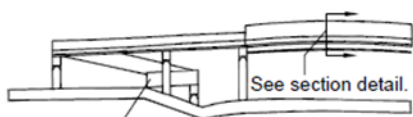

Check landing area for stopping sight distance requirements. Avoid direct entry into streets.

Multiuse Path Bridge Section

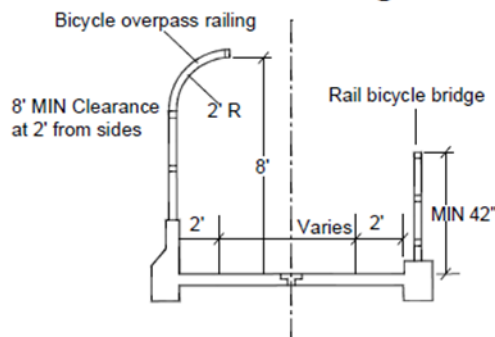

FIGURE 5-7.10 SHARED-USE OR MULTIUSE PATH – BRIDGES

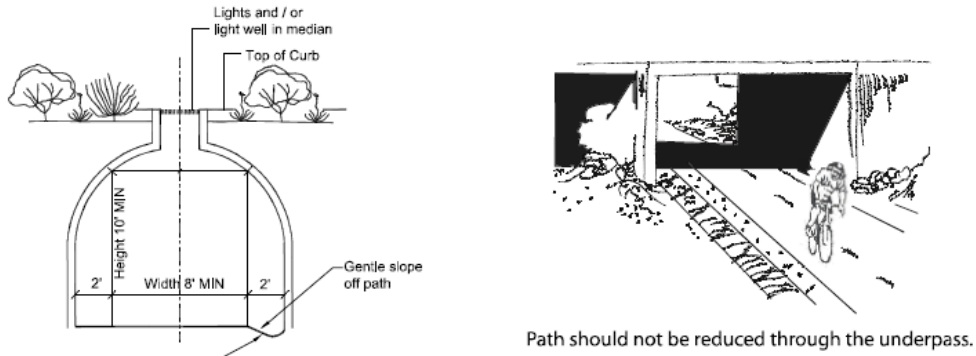

FIGURE 5-7.11 SHARED USE OR MULTIUSE PATH – TUNNELS

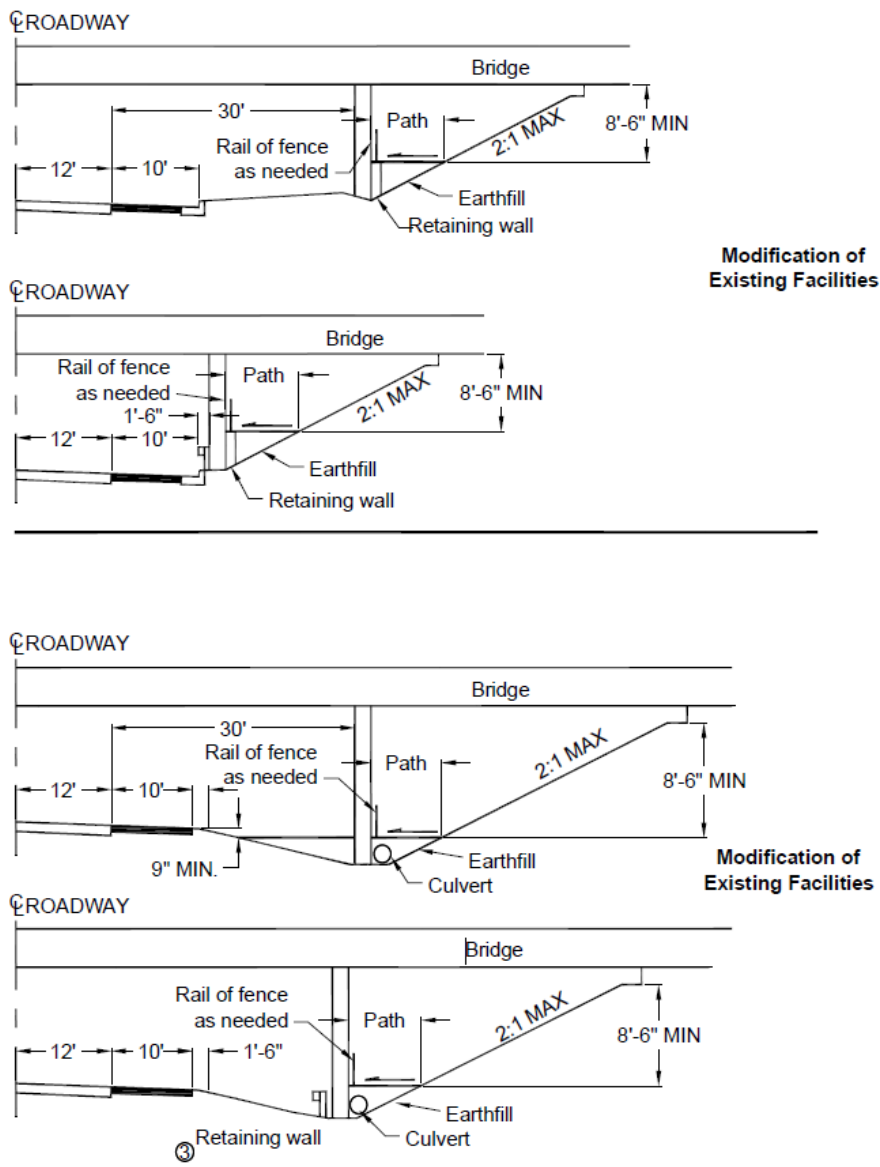

FIGURE 5-7.12 SHARED USE OR MULTIUSE PATHS UNDER BRIDGE STRUCTURES

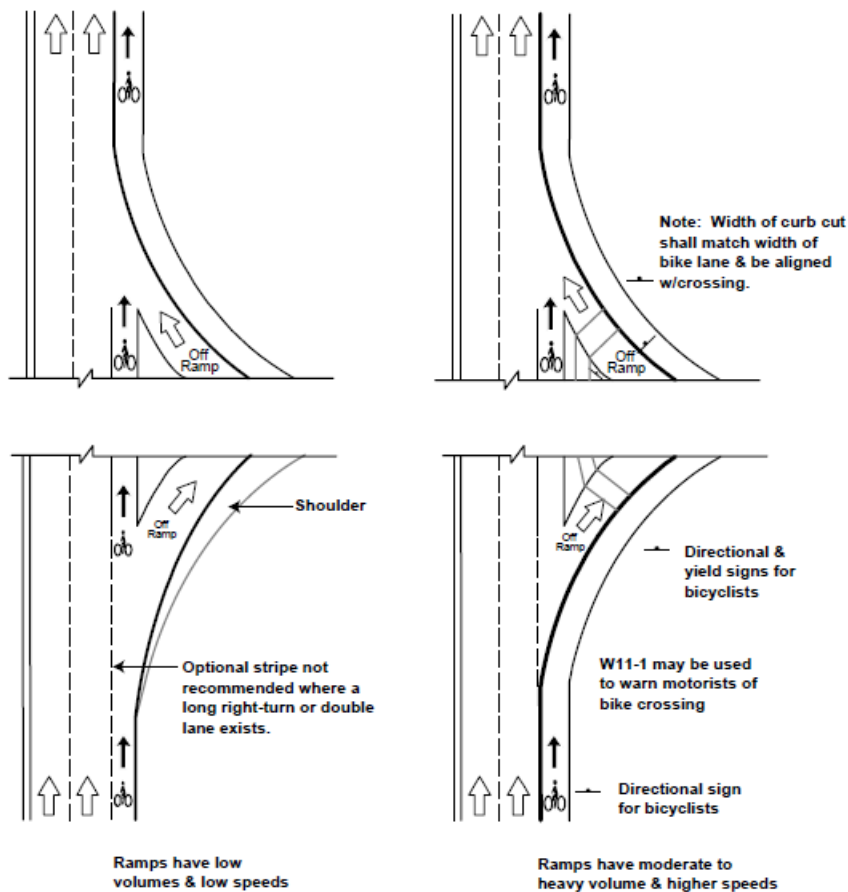

FIGURE 5-7.13 RAMP CROSSINGS

RIDING SURFACES

5-7.204

Careful attention should be made to the choice of riding surface paving materials and other objects within the riding surface. Typical riding surface materials are either Portland Cement Concrete or Asphaltic Concrete Paving.

- A. Portland cement concrete is desirable for paths with frequent contact with water. Paths constructed of Portland Cement Concrete will have a medium broom finish. The width of expansion joints should be minimized, and the joints saw cut with a small radius, instead of tooled.
- B. Asphalt Concrete Paving is desirable when dictated to complement aesthetics suitable to the surrounding area. Paths constructed of Asphalt Concrete Pavement shall conform to Section 343 of the City of Scottsdale Supplement to MAG Specifications. Paving for bike lanes should meet MAG standard for surface smoothness of asphalt paving. Asphalt Concrete Paving shall include an epoxy-coated surface.

Rumble strips, raised pavement markers, or raised curbs should never be used to delineate bike lanes or shared-use or multiuse paths. They should also never be placed in bikeway crossings.

Obstructions within the riding surface should be minimized. Drainage grates within the riding surface should be avoided whenever possible. Any drainage grates that must be placed in the riding path shall have bicycle safe grating.

TRAFFIC CONTROLS

5-7.300

SIGNS AND MARKINGS

5-7.301

Traffic control devices for cyclists, whether they are for an on- or off-street system, must adhere to the same five basic requirements for motorists:

- A. Fulfill a need,
- B. Command attention,
- C. Convey a clear, simple meaning,
- D. Command respect from users, and
- E. Give adequate time for a proper response.

The use of colors should conform to code specifications for signs and markings:

- A. Yellow – General Warning
- B. Red – Stop or Prohibition
- C. Blue – Service Guidance
- D. Brown – Recreation
- E. Black – Regulation
- F. Green – Information
- G. White – Regulation

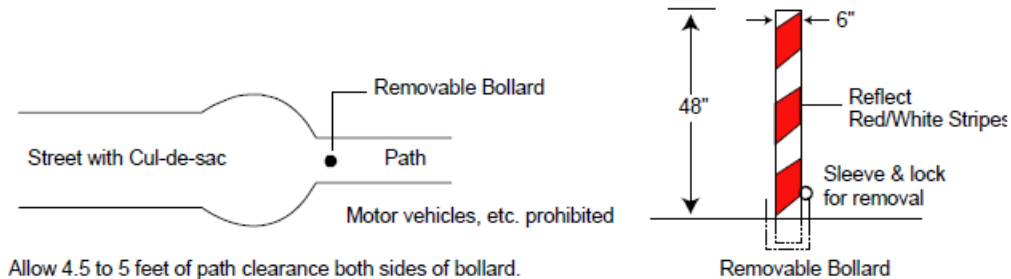

FIGURE 5-7.14 VEHICLE CONTROL PATH ENTRANCE (WHERE NEEDED)

All regulatory, warning and route marker signs will be provided in accordance with the standards in the Manual on Uniform Traffic Control Devices, Section IX. In addition, the city has developed signs for situations; refer to [COS Standard Details](#) Nos. 2281, 2282 and 2284.

Signing and marking for bike lanes are shown in Figure 5-7.1 through Figure 5-7.4, Figure 5-7.13 and Figure 5-7.16. Shared-use or multiuse paths are shown in Figure 5-7.13 and [COS Standard Detail](#) Nos. 2281, 2282 and 2284. Other information is in the AASHTO Guidelines.

For bike lanes, pavement markings shall consist of a directional arrow and a bike/rider symbol. In urban areas, pavement markings shall be placed 50 to 75 feet after every major intersection or at 1/4-mile intervals, whichever is less. In rural areas, the distance may change as judged appropriate by the COS Transportation Department.

Where a bike lane continues past the left side of a right-turn-only lane, a pair of pavement symbols shall be placed in that continuation.

On leaving an intersection, the lane stripe should start at the crosswalk or where the crosswalk would be. Approaching an intersection, with no right-turn lane, the stripe should be dashed 50 to 75 feet before the intersection. Refer to Figure 5-7.15.

Paint and thermoplastic stripes or markings used for lanes, routes or paths should be reflective and highly non-slip.

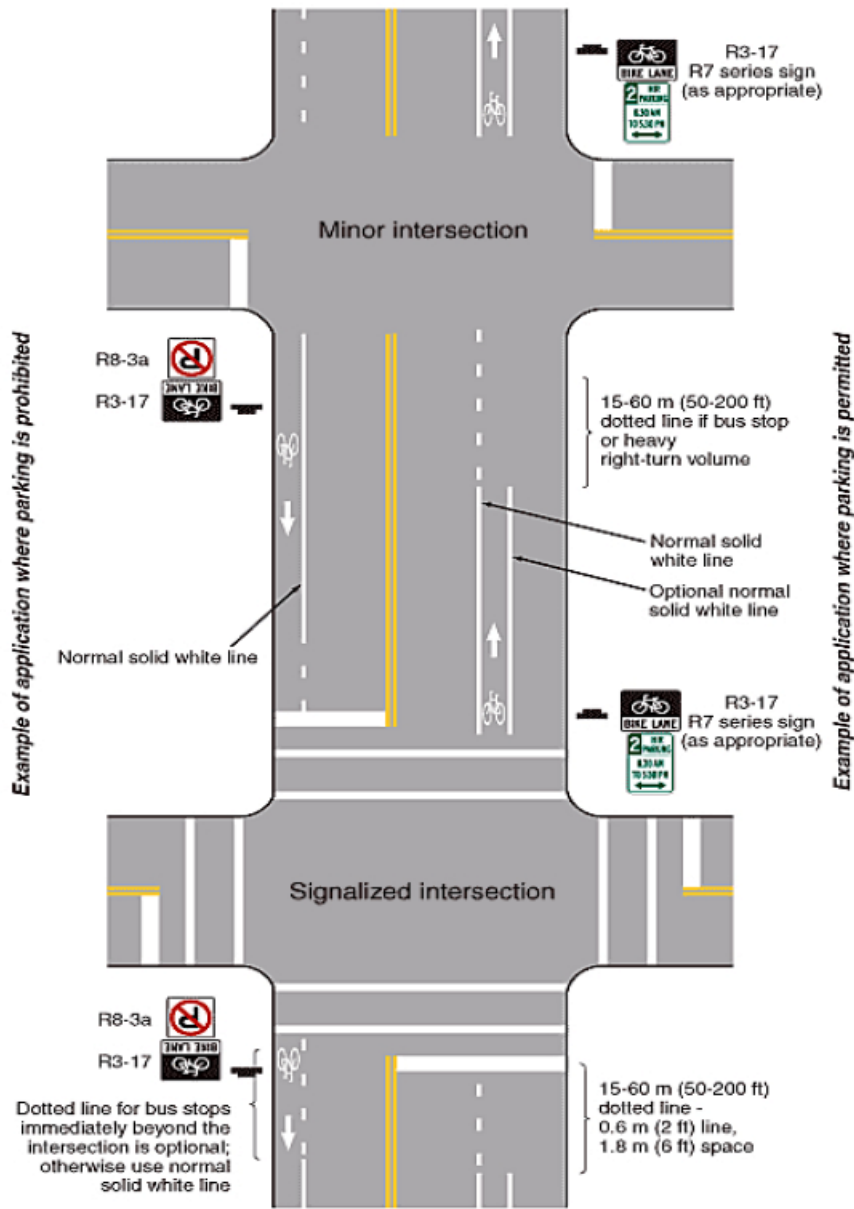

FIGURE 5-7.15 EXAMPLES OF PAVEMENT MARKINGS FOR BICYCLE LANES ON A TWO-WAY STREET; AND

FIGURE 5-7.16 BIKE LANE MARKINGS

DETOURS AND CONSTRUCTION

5-7.302

A. Public Information

Any signage, publication, map, web posting, public service announcement or other information concerning a construction closure, restriction or change will always include expected effects on cyclist or pedestrian movements. This includes, but is not limited to, changes in the operation of sidewalks, shared-use or multiuse paths, bike lanes or any other bikeways.

Ideally, detours should be identified or built and well signed. Bikeway detours should only be used when the same type of facility can be provided, such as a bike lane directed to other lanes or shoulders or to a suitable shared street. Path detours should be directed to another path or suitable sidewalk, not to an on-street facility.

B. Shared Streets, Bike Lanes and Shared-use or Multiuse Paths

If a bike lane is closed, it shall be signed "Bike Lane Closed" and also signed "Share the Road" for the portion where cyclists will be forced to use the traffic lane. This applies to shoulders with high bicycle use, as well as cases where the work is confined to the bicycle lane.

If the traffic lanes are narrowed for construction detours, so that a car and bicycle cannot safely pass side-by-side; then cyclists and motorists should be directed as in the previous paragraph.

Special attention needs to be paid to work, such as utility, taking place only in the bike lane or shoulder area. Sometimes precautions are ignored because the vehicular traffic is not affected. However, proper signing and barricading, with lights for night warning, is still essential. Irregular surfaces, such as raised metal plates on shoulders or hoses laid across paths, can be especially hazardous and must always be well barricaded.

Signing and barricading should anticipate night use and speeds up to 25 mph. Barricades and signs should be posted at points where people are able to choose an alternate route.

Barricades, signs, etc., should not be placed or stored in bike lanes or on shoulders or paths.

Bike lanes/shoulders shall always be restored to an excellent paving condition. MAG Standard 321.5.4, Asphalt Base and Surface Course, should apply (when not in use).

BICYCLE PARKING

5-7.400

The City of Scottsdale [Zoning Ordinance](#), Article IX, specifies bicycle parking requirements. For additional requirements, refer to DSPM Chapter 2.

Section 5-8

PUBLIC PEDESTRIAN FACILITIES

5-8

This section provides resources for pedestrian facility planning and design. It provides guidance for pedestrian connections, safety, and information on accessibility, including curb ramps.

GENERAL INFORMATION

5-8.000

The city is dedicated to improving the quality of life for its citizens by enhancing their mobility choices and enjoyment of the community. Pedestrians are an integral part of the transportation system because all people are pedestrians at one time or another. For example, a driver becomes a pedestrian upon leaving a vehicle. Public transportation users are pedestrians when they walk to a transit stop and again when walking to their final destination. Planning for the needs of pedestrians is an essential element of providing an efficiently functioning transportation system.

In general, people will choose to walk a ten-minute trip or a quarter mile to a destination, and even longer, up to twenty minutes or a half-mile, if the route is comfortable and safe or if the need is great. Site planning should consider walking distance of pedestrians from nearby transit routes or other adjacent locations, such as employment centers or residences. Like all transportation users, pedestrians seek direct, convenient travel routes.

Pedestrian facilities should provide accommodations for a wide array of users including but not limited to walkers, joggers, wheelchair users, strollers, in-line skaters, bicyclists and equestrians. These pedestrian facilities need to be universally accessible, safe, convenient, direct and designed to encourage use by this wide variety of potential users.

Minimizing curb cuts and consolidating driveways helps to maintain continuity of pedestrian routes and helps to ensure pedestrian comfort and safety. In addition, pedestrians like to be separated from moving traffic with a buffer, such as on-street parking, landscaping, or bicycle lanes. Walkways should be designed with sufficient capacity dependent on the anticipated level of use, intensity, and speed of adjacent traffic, and the number of obstacles (such as utility poles, magazine stands, and street furniture) within the walkway.

REFERENCES

5-8.001

This section draws extensively from the following sources:

- A. [2008 Scottsdale Transportation Master Plan](#)
- B. Proposed [Guidelines for Pedestrian Facilities in the Public Right-of-Way](#), Access Board, July 26, 2011.
- C. Pedestrian Policies and Design Guidelines, [Maricopa Association of Governments](#), 2004.
- D. Designing Sidewalks and Trails for Access, Part 1 and Part 2, Best Practices Design Guide, Barbra McMillen, et. al, USDOT, FHWA, Publication No. FHWA-EP-01-027 HEPH/8-01 (10M) E, September 2001. Available from FHWA Report Center by e-mailing report.center@fhwa.dot.gov.
- E. [Pedestrian Facilities Guidebook, Washington State Department of Transportation, September 1997.](#)
- F. [Pedestrian and Streetscape Guide, Georgia Department of Transportation, September 2003.](#)
- G. [Manual on Uniform Traffic Control Devices. FHWA, US Department of Transportation, 2009.](#)

H. [A Policy on the Geometric Design of Streets and Highways, American Association of State and Highway Transportation Officials \(AASHTO\), Washington, DC.](#)

The Transportation Department is available to answer questions or to discuss applications to specific circumstances or designs.

DESIGN GUIDELINES

5-8.100

These guidelines apply to typical situations encountered during project development. Unique situations will require flexibility in design solutions. In some situations, the current standard may not be achievable due to geometric, environmental, right-of-way or other constraints and flexible solutions will be determined by the project designers using appropriate professional judgment. In these circumstances, variances from the guidelines outlined in this section may be acceptable. However, a facility should not typically be built to less than the guidelines described in this section unless approved by the Transportation Director in conjunction with the Planning and Development Director.

SIDEWALK WIDTH AND PEDESTRIAN ACCESS ROUTES

5-8.200

The connection between on-site and public sidewalks should provide convenient and identifiable access. Safe pedestrian travel ways must be defined by walkways visually and functionally separate from the path of vehicles.

All sidewalks and walkways should provide a minimum width of 6 feet of travel space to accommodate pedestrians moving in both directions, including pedestrians using assistive devices. This minimum width does not include additional space that may be required to accommodate landscaping, door-swings, and site furnishings. Additional minimum width may be required in areas with a higher level of pedestrian traffic. Refer to Section 5-3.300.

All pedestrian access routes and pedestrian arrival locations within the public right-of-way should be connected to the on-site primary pedestrian circulation route(s) by a sidewalk that has a minimum width of 6 feet. Incidental on-site secondary pedestrian circulation routes may connect to the pedestrian routes within the public right-of-way by a sidewalk that has less than 6-feet wide if approved by the Transportation Director in consultation with the Planning and Development Director.

While meandering sidewalks have aesthetic appeal, they tend to negate an efficient and effective pedestrian travel environment. Meandering sidewalks should be limited to areas where latent demand is low or where topography or site conditions require deviation from a straight configuration. Minimum design speed for sidewalks/walkways should be comparable to minimum design speed for paths.

SIDEWALK SURFACE, TEXTURE AND SLOPE

5-8.201

Sidewalks should be even without heaving. Sidewalks should:

- A. Not have bumpy or textured surfaces, or cracks or indents greater than 1/4 inch in width or depth.
- B. Be firm, stable, slip-resistant, and sloped for drainage, but not more than a 1:12 (rise to run) slope ratio.

- C. Refer to Chapter 12 of the DSPM for additional information pertaining to maximum level change, gap, and slope of pedestrian access routes.
- D. Sidewalks should contrast in color or tone from the surrounding area unless there is a desired character in a specific area that precludes contrasting color. In these situations, texture or materials should provide the contrast as opposed to color.
- E. In the northern areas of Scottsdale, colored concrete instead of gray or white is to be if matches the Davis Colors San Diego Buff. Additional colors may be approved in the northern areas of Scottsdale by the Transportation Director in consultation with the Planning and Development Director. The walkway can be a different material, texture, or color to distinguish it from the vehicular traffic area, although all pedestrian access routes shall comply with Chapter 12 of the DSPM.
- F. Sidewalks in suburban and urban areas should be concrete.
- G. Alternative surfacing of sidewalks may be appropriate for parts of the community that desire to have alternative surfaces, provided that those surfaces are firm, stable, and slip resistant.
- H. Pedestrian access routes constructed with alternative surfaces shall comply with Chapter 12 of the DSPM.

CLEARANCES

5-8.202

While site furnishings, street vendors, and outdoor dining areas enhance variety and provide interest to pedestrian areas, they should not be designed or located where they protrude into the pedestrian route. Protrusions are hazardous, especially to pedestrians with low vision, or pedestrians walking in groups that may not be fully attentive to their surroundings. Pedestrian areas should meet the following clearances:

- A. Minimum 5-foot separation from the edge of the roadway, with 10 feet desired if there are adjacent buildings. In areas where buildings are set back farther, a greater separation from the roadway is desired up to 25 feet.
- B. 6-foot minimum clear width on the pedestrian access route, exclusive of obstructions or protruding objects such as door-swing areas, furniture, vegetation, and light poles.
- C. Compliance with Chapter 12 of the DSPM and the ADA.

PUBLIC REALM

5-8.203

In urban areas of the City, such as the Downtown Area, the pedestrian route(s) typically occurs between the street curb and the adjacent building facade. This area is commonly called the pedestrian realm, street side zone, total walkway width, etc. (herein the "public realm"). Generally, the public realm is a combination of hard- and soft-scape improvements that provides the appearance of a plaza with a defined pedestrian route. Also, this area has variety of widths and clearances that typically include building entries, building mounted objects, bus stops, courtyards, landscape plant material, patios, pedestrian furniture, and signs.

- A. The pedestrian route sidewalk width through public realm should be provided in accordance with Section 5-3 of the DSPM; but, shall not be less than 6 feet wide. The Planning and Development Director in consultation with the Transportation Director may approve width less than 6 feet.

- B. Generally, courtyards, pedestrian furniture, and patios occur between the curb and the pedestrian route sidewalk, or between the building façade and pedestrian route sidewalk. When patios and courtyards are incorporated into a public realm between the building façade and the pedestrian route, the patio or courtyard shall be setback a minimum of 14 feet from the back of the adjacent curb. This could be reduced under the following conditions with the Transportation Planning Director in consultation with the Planning and Development Director:
1. 6 feet from the back of the curb when adjacent to parallel parking or a bike lane; or
 2. 8 feet from the back of the curb when adjacent to angle and perpendicular parking; and
 3. Where the patio would not obstruct the straight, clear, and unobstructed width of the pedestrian route sidewalk.
- C. The patio or courtyard provided in the public realm should not cause the pedestrian route sidewalk to be rerouted around the patio. Rerouting of the pedestrian route sidewalk is discouraged unless a majority of the pedestrian sidewalk on the street frontage is reconfigured so that the sidewalk is straight, clear, and unobstructed.
- D. When patios and courtyards are incorporated in the public realm between the curb and the pedestrian route sidewalk, the following should be provided:
1. A barrier to prevent pedestrians from walking in the street;
 2. A minimum of 2 feet setback from the face of the adjacent curb to the patio or courtyard barrier;
 3. In a location other than the corner of intersecting streets;
 4. Outside a line of sight for vehicular traffic and sight distance;
 5. A barrier(s) to assist in minimizing the effects of a vehicular crash in to the patio or courtyard; and
 6. Any other requirement determined by city staff.
- In addition, the pedestrian route sidewalk between the patio and building facade should have a width of 8 feet.
- E. Requirements for all pedestrian areas:
1. Wall mounted objects should not protrude more than 4 inches from a wall when located between 27 inches and 7 feet above or near a pedestrian route sidewalk. Single-post mounted objects should not overhang more than 4 inches per side of post when located between 27 inches and 7 feet above the pedestrian route sidewalk.
 2. The lowest edge of an object mounted on multiple posts having a clear distance between adjacent posts greater than 1 foot shall be no higher than 27 inches or no lower than 7 feet.
 3. Trees should be trimmed in accordance with Chapter 8 of the DSPM.
 4. The understory to trees, shrubs, and groundcovers should be free of thorny plants within 4 feet of the edge of the pedestrian route sidewalk.

DRIVEWAY CROSSINGS AND ACCESS MANAGEMENT

5-8.204

To the extent possible, driveway crossings should be minimized in areas classified as medium high or high on the pedestrian route network maps. Driveways that intersect

sidewalks and walkways should be designed to minimize conflicts between pedestrians and vehicles.

CURB RAMPS

5-8.205

Ramps provide access between changes in elevation for people using mobility assistive devices, and people pulling or pushing strollers, suitcases, or other items.

- A. Curb ramps should be wholly contained within the crosswalk markings, if they exist.
- B. Ramps function best when placed in the center of the crosswalk.
- C. Curb ramps should be flush with the street surface, meeting with the surface at grade, without transitions or lips.
- D. Alterations in retrofit development areas shall follow guidelines for new construction unless technically infeasible as determined by the Transportation Department.

The city is improving pedestrian access and safety by requiring the use of directional ramps at most intersections.

- A. Directional ramps are preferred and should be installed at all intersections where there is room for both the ramps and the required 4-foot landing area.
- B. Where there is not room for the full directional ramp treatment, diagonal ramps with a minimum 8-foot width and 4-foot landing are acceptable.
- C. If there is not room for the landing, a blended transition ramp should be used.
- D. Detectable warning devices shall be provided as required by ADA. Refer to Chapter 12 of the DSPM.
- E. Additional guidance available from the [FHWA](#).

PHYSICAL SEPARATION FROM TRAFFIC

5-8.206

Sidewalks should be separated from adjacent roadways with either vertical or horizontal separation. Vertical separation can be curbs, bollards, parking (parallel or perpendicular), or buildings. Horizontal separation can be an on-street bike lane, a non-paved area (preferably landscaped), or landscaping in tree grates or planters. Separations that include landscaping to shade pedestrians that also provide softening of the environment are encouraged. On roadways with transit routes, the sidewalk should be brought closer to the roadway at transit stop locations to allow boarding and deboarding at transit stops. Bollards can be used as a vertical element to separate pedestrians from traffic. Refer to AASHTO roadside design guide for placement. Buildings act as a vertical separation in situations where the pedestrian facility is completely, or almost completely, separated from roadways by buildings, in areas such as plazas or pocket parks.

LIGHTING

5-8.207

Pedestrian level lighting should be provided in urban areas and in suburban areas where pedestrian activity is expected during non-daylight hours.

INTERSECTIONS

5-8.208

Refer to the Manual on Uniform Traffic Control Devices.

SHADE

5-8.209

Pedestrians in the Scottsdale area will seek protection from the sun, therefore shade should be considered during design.

SEATING

5-8.300

Comfortable and frequent seating can help promote walking and creates a comfortable pedestrian environment.

Section 5-9

NEIGHBORHOOD TRAFFIC MANAGEMENT

5-9

This section identifies the process and criteria for reviewing and resolving neighborhood traffic concerns. It identifies goals for this program and options for resolving conflicts.

GENERAL INFORMATION

5-9.000

Continued growth in Scottsdale and the region has increased Scottsdale residents' concerns regarding traffic, specifically in neighborhoods. To promote safe and pleasant conditions for residents including motorists, bicyclists, pedestrians, schoolchildren, and other users on neighborhood streets, Scottsdale's Transportation Department has created a [Neighborhood Traffic Management Program \(NTMP\)](#). One component of the quality of life expected by Scottsdale residents is the safe, efficient, and economical movement of people and goods. The goal of the NTMP is to use the three "E's" (Education, Enforcement, and Engineering) to address the transportation concerns of residents who are negatively impacted by vehicular traffic in their neighborhood.

The NTMP is not designed to address dangerous intersections, mitigate noise, or to redesign the overall transportation/street classification system, as these concerns should be addressed separately.

APPLICATION

5-9.001

Application of the NTMP shall be limited to local, paved, public streets that:

- A. Have or are planned to have no more than one travel lane in each direction, and
- B. Function primarily to connect an origin or destination to an arterial (local residential and some minor collectors).

REFERENCES

5-9.002

- A. MAG Standard Drawings - Maricopa Association of Governments (MAG)
- B. COS Supplement to MAG - City of Scottsdale
- C. DSPM Section 5-3.400, Roundabouts
- D. Traffic Calming: State of the Practice - Institute of Transportation Engineers
- E. Manual on Uniform Traffic Control Devices - FHWA
- F. A Policy on the Design of Highways and Streets - AASHTO
- G. Roundabouts: An Informational Guide - FHWA

GOALS

5-9.100

The city has developed its NTMP with the following goals:

- A. Minimize negative impacts of traffic in neighborhoods through ongoing monitoring and improvement of the overall transportation system.
- B. Work to ensure that proposed land uses, and their associated travel demands, do not negatively impact surrounding/adjacent residential neighborhoods.
- C. Protect Scottsdale's residential neighborhoods from "unwanted" vehicle traffic. "Unwanted" vehicle traffic is defined as any one of the following:
 1. Traffic operating at excessive speeds,
 2. Vehicles with an origin and destination outside the neighborhood, or
 3. An excessive volume of traffic on a residential local or minor collector street.
- D. Balance the often-conflicting needs of calming traffic and maintaining emergency response capability. Emergency vehicle access must be preserved.

- E. Address resident traffic concerns while minimizing any negative affects to other citizens and neighborhoods.
- F. Encourage and enhance bicycle, pedestrian, and other non-motorized travel modes.
- G. Achieve broad-based citizen participation, which is an essential element in the development of an effective Neighborhood Traffic Management Program.

PROCEDURES

5-9.200

Traffic calming requests will be processed according to the guidelines of the NTMP policy adopted by the City of Scottsdale Transportation Commission in October 2010. All traffic calming requests will be required to complete the Speed Awareness Program (SAP) prior to being considered for engineering solutions.

Traffic Engineering will then review projects based on qualification criteria documented in the NTMP policy to determine the eligibility of the roadway requesting traffic calming. Projects that meet the qualifications of the NTMP will proceed to neighborhood meetings, design of potential traffic calming measures, public meetings and outreach, and documentation of neighborhood support. Projects with documented neighborhood support will be presented to the City of Scottsdale Transportation Commission for approval of funding for construction.

All traffic calming requests related to development activity will be reviewed by the Transportation Department as part of the development review process. Developers are not to make proposals directly to residents without consulting Traffic Engineering staff. Traffic Engineering staff will review and make recommendations that may include:

- A. Design mitigation
- B. A formal Traffic Impact Mitigation Analysis (TIMA) process – refer to Section 5-1.100
- C. Neighborhood meetings
- D. Review by the Transportation Commission

Section 5-10

FLEXIBLE PAVEMENT

5-10

This section describes procedures for designing structural sections of flexible pavements constructed within the city's public rights-of-way.

GENERAL INFORMATION

5-10.000

DEPTH AND MIX REQUIREMENTS

5-10.001

The asphalt concrete portion of a flexible pavement shall have a minimum depth, number of courses, and mix design called for by street classification in Figure 5-10.1. The mix design references are taken from the East Valley Asphalt Committee (EVAC) Design Standards and from Section 710 of the MAG Specifications and the City of Scottsdale Supplements to MAG and City of Phoenix Asphaltic Concrete Design Specifications. Mix designs and course thicknesses other than those specified in Figure 5-10.1 may not be used unless approval is provided by the Transportation Director or appointed designee. Minimum lift thicknesses are also outlined in Table 710-1 of the COS Supplements to MAG Specifications. The mix design and course thicknesses are to be clearly indicated on paving plans for public rights-of-way improvements.

STREET CLASSIFICATION	TYPE OF MIX	MIN. DEPTH	TYPE OF MIX (From MAG TABLE 710-1)		
			Asphalt Base - 1st Lift	Asphalt Base - 2nd Lift	Rubberized Asphalt Surface Course**
Local Residential Minor Collector Local Collector Local Industrial	Marshall	3"	3" of R-1/2 * 2" of R-1/2"		1" of 1/2" gap graded Rubberized asphalt **
Major Collector	Gyratory	6"	3" of A-3/4"	2" of A-1/2"	1" of 1/2" gap graded Rubberized asphalt **
Minor Arterial Major Arterial	Gyratory	7"	3" of A-3/4"	3" of A-3/4"	1" of 1/2" gap graded Rubberized asphalt **

* At COS discretion ** Reference City of Phoenix specifications

FIGURE 5-10.1 MINIMUM ASPHALT CONCRETE DEPTH REQUIREMENTS

USE OF RECYCLED ASPHALT CONCRETE

5-10.002

Recycled asphalt concrete may not be used in the construction of asphalt concrete pavements.

SOIL TESTING REQUIREMENTS

5-10.100

SUBGRADE SAMPLING LOCATIONS

5-10.101

There should be at least one sample taken at the depth of the planned subgrade for each type of soil found on the project site. There should also be at least one sample for each type of soil used as fill material on which a roadway is to be built. The engineer

responsible for the pavement design should take samples in locations that will provide an accurate representation of the subgrade lying beneath the pavement.

TYPE OF TESTS

5-10.102

The following tests are required for design procedures indicated and must be performed in accordance with the American Society for Testing Materials (ASTM) procedures.

- A. To use the base course design standards and policies for minor streets described in Section 5-10.200, the following tests are required:
 1. Sieve analysis is needed to determine the percent passing #200 sieve.
 2. Atterberg-Limits tests for each sample.
- B. To use the base course design procedures for major streets described in Section 5-10.300, or to use the structural section design procedures described in Section 5-10.400, R-value testing is required.

R-value determination shall be made for exudation pressure of 3000 pounds per square inch (psi). Each pavement thickness design must be based on the R-values determined by the tests, and for each length of pavement to be constructed with a constant thickness design; the lowest R-value within that length of pavement will be used. If the engineer elects not to run R-value tests on every subgrade sample, the design report must indicate the basis on which the engineer selected the samples for the R-value tests.
- C. Swelling tests are needed if the soil type indicates the presence of soils tending to swell significantly with added moisture.

PAVEMENT DESIGN REPORT

5-10.103

A pavement design report is required for each development or project in which paving in the public rights-of-way will be done. This report must be submitted with the paving plans (or be a part of them) and must describe the soil test results and design choices. The report must include the following:

- A. A map of the project area showing identification and location of each sample taken.
- B. A description of the soil conditions.
- C. A listing of the test results on each sample.
- D. A statement of conclusions applicable to the pavement design.

BASE COURSE FOR MINOR STREET

5-10.200

BASE COURSE DESIGN CHARTS

5-10.201

The two design charts for the base courses of minor streets are shown in the following two figures:

- A. Figure 5-10.2 is a chart for the design of base courses for Local Residential Streets.

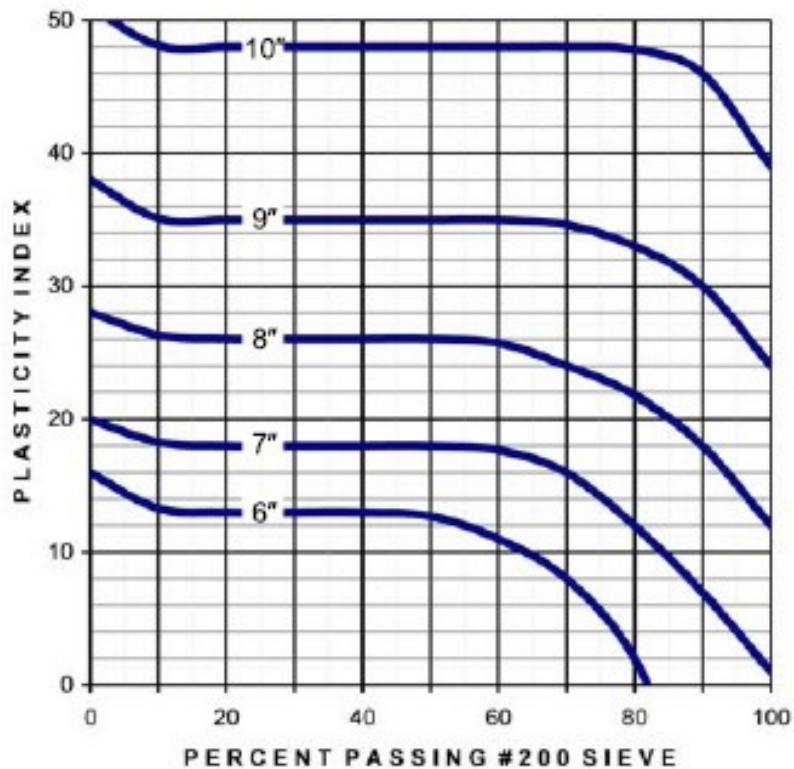

**Bold lines represent the upper limits of each zone.*

FIGURE 5-10.2 MINIMUM DEPTH OF BASE COURSE FOR LOCAL RESIDENTIAL STREETS

B. Figure 5-10.3 is a chart for the design of base courses for:

1. Minor Collector Streets
2. Local Commercial Streets
3. Local Industrial Streets

Note: The top 4 inches of the base course shall be ABC and the balance shall be ABC or select material (SM).

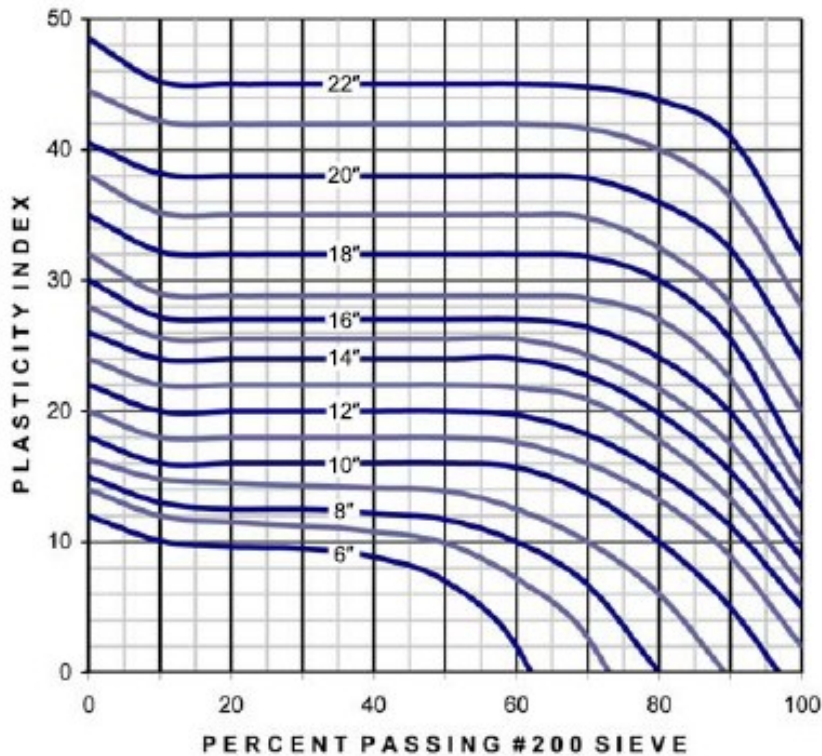

**Bold lines represent the upper limits of each zone*

FIGURE 5-10.3 BASE COURSE FOR LOCAL AND MINOR COLLECTORS, LOCAL COMMERCIAL AND LOCAL INDUSTRIAL STREETS

BASE COURSE SELECTION PROCEDURE

5-10.202

Determine a minimum base course depth by cross-referencing the plasticity index to the percent of soil passing the #200 sieve (determined by the subgrade soils tests).

Example:

If building a Minor Collector Street on subgrade soil with a Plasticity Index of 12, and 60% of the soil passes the #200 sieve, the base course depth will be 9 inches (Figure 5-10.3). A Local Residential Street on the same subgrade soil will have a base course of 7 inches (Figure 5-10.2). Referring to Figure 5.10-1, we find that at least 3 inches of R-3/4" asphaltic concrete will be placed over either of these two bases.

BASE COURSE FOR MAJOR STREET

5-10.300

BASE COURSE DESIGN CHARTS

5-10.301

The base course depths listed in Figure 5-10.4 are arranged in accordance with the street classifications and the R-values determined in the subgrade testing. The depths are determined by the procedures used for design of structural sections described in Section 5-10.400. For a given street classification, the street with the heaviest current and projected traffic loading was used to determine the range of base course depths

for all streets of that classification; therefore, the base course depths listed in this chart will provide conservative pavement designs.

Street Classification	R-Values										
	0-5	5-10	10-15	15-20	20-25	25-30	30-35	35-40	40-45	45-50	50+
Major Collector	26	24	22	20	18	16	14	12	11	10	9
Minor Arterial	29	27	25	23	20	18	16	14	12	10	9
Major Arterials											

FIGURE 5-10.4 MINIMUM DEPTH OF BASE COURSE

BASE COURSE SELECTION PROCEDURE

5-10.302

A base course depth is selected for a major street by finding the depth in inches for the appropriate street classification under the proper R-value range.

Example:

If a Major Collector Street were built on subgrade soil with an R-value of 38, the base course would be 12 inches deep. According to Figure 5-10.1, at least 5 inches of asphaltic concrete must be laid over the base course.

DESIGN OF STRUCTURAL SECTIONS

5-10.400

MODIFIED AASHTO DESIGN PROCEDURES FOR EXPRESSWAYS

5-10.401

AASHTO published a guide for the design of pavement structures in 1961 and a revised guide in 1972. ADOT modified the procedures provided in the AASHTO design guide to meet requirements for the State of Arizona. The City of Phoenix uses the ADOT modified procedures and has selected certain design coefficients appropriate to the Phoenix metropolitan area. The City of Scottsdale also uses the ADOT-modified procedures with the City of Phoenix coefficients.

Assumptions:

ADOT uses its own adoption of the procedures outlined in the "AASHTO Guide for Design of Pavement Structures" published in 1961 and revised in 1972. The following assumptions must be made:

- A. The soil support capacity of the subgrade soils can be predicted adequately by testing to determine R-values.
- B. The R-values can be effectively related to a soil-bearing capacity rating scale called the soil support value.
- C. A suitable pavement depth is determined by a procedure that considers the soil support value in conjunction with projected traffics loading, environmental conditions, and weighted structural values for the various components of the pavement structure.

DESIGN PARAMETERS

A. Soil Support Value

The soil support value represents the bearing capacity of the subgrade soil. It is determined by a relationship established between its scale and the R-value scale, as shown in Figure 5-10.5. This relationship is not uniform throughout the country. ADOT has established the relationship determined by the following equation:

$$SS = 0.094R + 1.75$$

SS = Soil Support Value

R = R-Value

B. Serviceability Index

Serviceability Index is a number that represents the surface condition of roadway in terms of ride-ability, cracking, patching, and rutting at some point in its design life. It is used in the design equation to represent the theoretical loss of serviceability over the 20-year design period. The Initial Serviceability Index is 5.0. The Terminal Serviceability Index varies, depending upon the level of service desired. Scottsdale uses a Terminal Serviceability Index of 2.5.

R-VALUE	SOIL SUPPORT VALUE	R-VALUE	SOIL SUPPORT VALUE	R-VALUE	SOIL SUPPORT VALUE
0	1.750	30	4.570	60	7.390
1	1.844	31	4.664	61	7.484
2	1.938	32	4.758	62	7.578
3	2.032	33	4.852	63	7.672
4	2.126	34	4.946	64	7.766
5	2.220	35	5.040	65	7.880
6	2.314	36	5.134	66	7.954
7	2.408	37	5.226	67	8.048
8	2.502	38	5.322	68	8.142
9	2.596	39	5.416	69	8.236
10	2.690	40	5.510	70	8.330
11	2.784	41	5.604	71	8.424
12	2.878	42	5.698	72	8.518
13	2.972	43	5.792	73	8.612
14	3.066	44	5.886	74	8.706
15	3.160	45	5.980	75	8.800
16	3.254	46	6.074	76	8.894
17	3.348	47	6.168	77	8.958
18	3.442	48	6.262	78	9.082

R-VALUE	SOIL SUPPORT VALUE	R-VALUE	SOIL SUPPORT VALUE	R-VALUE	SOIL SUPPORT VALUE
19	3.536	49	6.358	79	9.176
20	3.630	50	6.450	80	9.270
21	3.724	51	6.544	81	9.364
22	3.818	52	6.638	82	9.458
23	3.912	53	6.732	83	9.552
24	4.006	54	6.826	84	9.646
25	4.100	55	6.920	85	9.740
26	4.194	56	7.014	86	9.834
27	4.288	57	7.108	87	9.928
28	4.382	58	7.202	88+	10.000
29	4.476	59	7.296		

FIGURE 5-10.5 ADOT MATERIAL SERVICES R-VALUE AND SOIL SUPPORT VALUE RELATIONSHIP

C. The Structural Number (SN)

The SN is derived from an analysis of traffic, subgrade soil conditions, and environmental conditions, and is used in conjunction with structural layer coefficients (related to the type of material used in each layer) to calculate the thickness of a flexible pavement structure consisting of various flexible layers.

The following is the equation for the SN developed from data accumulated by AASHTO:

$$SN = \left[\frac{\{(10504) (Wt^{0.10684}) (R^{0.10384})\}}{\{(10^{0.039714(SS-3)}) (10^{0.10684(Gt/B)})\}} - 1 \right]$$

- SN = Structural Number
- Wt = Total 18,000 pound, single-axle loads
- R = Regional Factor=1.0
- SS = Soil Support Value
- B = $0.40 + [(0.081 * 19^{3.23}) / (SN+1)^{5.19}]$
- Gt = $[(P_o - P_t) / P_o - 1.5]$
- P_o = Initial Serviceability Index = 5.0
- P_t = Terminal Serviceability Index = 2.5

Since “SN” appears on both sides of the equation, the solution can be most rapidly done by nomograph. Figure 5-10.6 is a nomograph developed by ADOT for this purpose, with a Terminal Serviceability Index of 2.5 and a Regional Factor of 1.0

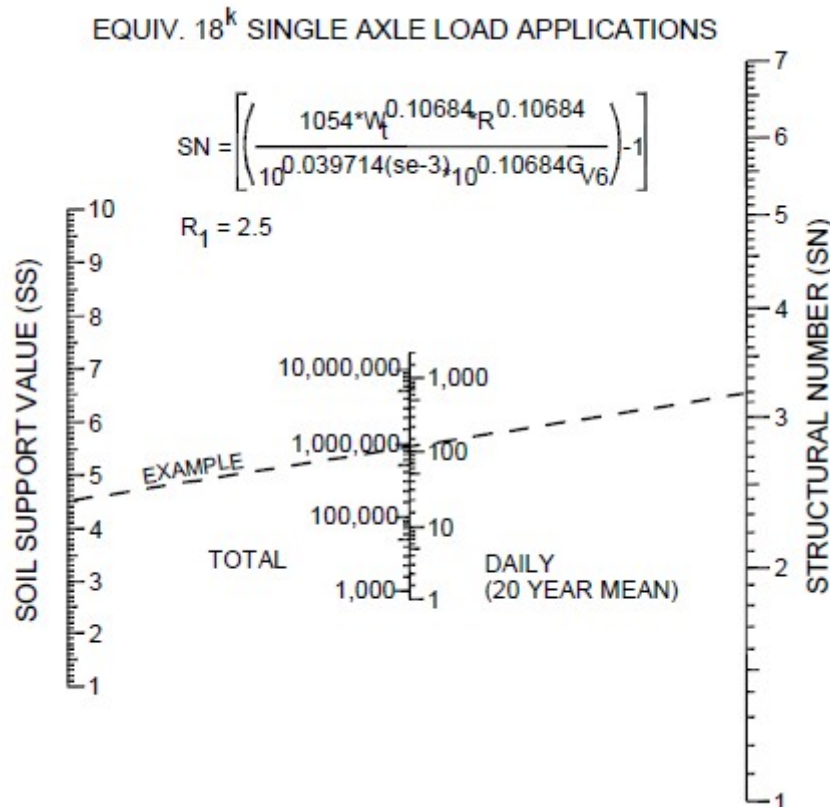

FIGURE 5-10.6 FLEXIBLE PAVEMENTS, 20-YEAR TRAFFIC ANALYSIS

Example:

Soil Support Value = 4.5

Equivalent 18^k single axle load app. Daily (20-year mean) = 140

SN = 3.2

PROJECTED TRAFFIC LOADING

5-10.403

The Projected Traffic Loading is an equivalent daily application of 18,000-pound (18K) single-axle loads. All vehicle use data during a 20-year period must be converted to equivalent 18K single-axle load applications to use with Figure 5-10.6. The load applications can be expressed either as a daily 20-year mean or as the total of the load applications applied over a 20-year mean, times 365, times 20. The data required consists of the following:

- A. Current ADT (traffic flowing in both directions)
- B. The 20th year ADT (traffic flowing in both directions)
- C. Percentage of each type of vehicle classification

The steps described below will provide the vehicle load information used in Figure 5-10.6.

A. Average ADT in One Direction

Determine the average of the current ADT and the terminal year ADT, and then divide by 2 to arrive at an average ADT in one direction. Express this quantity in terms of thousands of vehicles.

Example:

Current ADT = 19,500 vehicles

Terminal ADT = 33,000 vehicles

$$[(19.5+33.0) / 2] (0.5) = 13.125$$

B. Equivalent Single Axle Loads

Calculate the 18K equivalent single-axle load applications using the vehicle distribution percentages determined by a traffic survey and the 18K single-axle load for each type of vehicle listed in Figure 5-10.7.

Notation	Type of Vehicle	18k Single-Axle Equiv. Per 1000 Vehicles
C	Passenger cars	0.8
B	Buses	250.0
2P	Light 4-tire trucks	1.2
2S	Heavy 4-tire trucks	5.8
2D	2-axle, 6-tire trucks	163.2
3D	3-axle trucks	598.7
2S1	2-axle tractor, 1-axle semi-trailer	408.2
2S2	2-axle tractor, 2-axle semi-trailer	956.5
3S2	3-axle tractor, 2-axle semi-trailer	514.3
2-2	2-axle truck, 2-axle semi-trailer	304.3
3-2	3-axle truck, 2-axle full trailer	936.8
3-3	3-axle truck, 3-axle full trailer	936.8
2S1-2	2-axle tractor, 1-axle semi-trailer, 2-axle full trailer	846.7
3S1-2	3-axle tractor, 1-axle semi-trailer, 2-axle full trailer	958.0

FIGURE 5-10.7 18 K SINGLE-AXLES EQUIVALENT LOADS BY TYPE OF VEHICLE

Example:

If commercial vehicles make up 23.9% of all vehicles using the roadway, heavy four-tire trucks (Type 2S) make up 18.3% of all commercial vehicles, and the Type 2S 18K single-axle equivalent per 1,000 vehicles is 5.8, as indicated in Figure 5-10.7, then the load application for this type of vehicle per 1,000 vehicles is:

$$(0.239) (0.183) (5.8) = 0.254$$

C. 20-Year Mean

The sum of all such loads is the equivalent 18K single-axle load per 1,000 vehicles traveling the road. This sum must be multiplied by the average ADT for traffic in one direction calculated above in Step A. The result of this multiplication is the number of daily, 20-year mean, and equivalent 18K single-axle loads produced by traffic moving in one direction.

D. Lane Load

For streets with more than one lane in each direction, multiply the load calculated in Step C above by the following appropriate factor to calculate the design lane load:

1. If the street is to have 2 lanes in each direction, multiply the number of equivalent 18K single-axle loads by 0.90 to arrive at a design lane equivalent 18K single-axle loading.
2. If the street is to have 3 lanes in each direction, multiply the number of equivalent 18 K single-axle loads by 0.70 to arrive at a design lane equivalent 18K single-axle loading. The calculations described above provide the number of daily equivalent 18K single-axle (20-year mean) loads to be used in Figure 5-10.6.

REGIONAL FACTOR

The Regional Factor is used to adjust the SN for climatic and environmental conditions different from those of the AASHTO road test site. The Regional Factor is 1.0. The nomograph shown on Figure 5-10.6 is an abbreviated form of the nomograph prepared by ADOT; no adjustment of the SN for regional conditions is needed.

5-10.404

STRUCTURAL FACTOR

The components of the pavement structure are assigned structural coefficients to be used with the SN in developing the design of pavement section. The coefficients shown below were developed by the City of Phoenix from experience, tests, and correlation with information in ADOT design manuals and MAG Specifications.

5-10.405

Local Pavement Component	ADOT Range	Local Coefficient
Asphaltic Concrete (plant mix)	0.34 to 0.46	0.39
Bituminous Treated Base	0.30 to 0.35	0.31
Cement Treated Base*	0.15 to 0.29	0.23
Aggregate Base	0.08 to 0.14	0.12
Select Material (SM)	0.05 to 0.12	0.11

* *The Cement Treated Base coefficient is for plant mix. If a road mix is used, the percentage of cement to be used must be increased by 0.5%.*

FIGURE 5-10.8 STRUCTURAL COEFFICIENTS

DESIGN PROCEDURE

- A. Determine the SN for the pavement to be designed, using the following method:
 1. Determine the R-values by testing and select an R-value for the design, using the equation found in Section 5-10.402.
 2. Calculate the equivalent 18K single-axle load application for the length of the street for which the pavement design is required, using the calculation described in Section 5-10.403.
 3. Using the Soil Support Value obtained in 1.a. above, plot that value on the Soil Support Value Scale in Figure 5-10.6.

5-10.406

4. Using the equivalent 18K single-axle, 20-year load total or the daily, 20-year mean traffic loading data obtained in 1.b. above, plot the traffic load on the appropriate scale on Figure 5-10.6.
 5. Draw a straight line from the point plotted on the Soil Support Value Scale of Figure 5-10.6 through the point plotted on the equivalent 18K single-axle load scale until it intersects the SN Scale. Use the SN that can be read at its intersection for the pavement design.
- B. Use the SN to calculate the thickness of the structural components with the following equation:

$$C_1D_1 + C_2D_2 + C_3D_3 \dots C_ND_N = SN$$

C_1, C_2, C_3 = Structural Coefficient (from Section 5-10.405)

$D_1, D_2, D_3 \dots$ = Thickness of Component

Example:

From Section 5-10.405, we find that the structural coefficients are 0.39 for the asphaltic concrete, 0.12 for the ABC and 0.11 for the SM. The calculation of the thickness of the SM is accomplished in the following manner:

$$C_1D_1 + C_2D_2 + C_3D_3 = SN$$

$$(0.39)(5) + (0.12)(4) + (0.11)(SM) = 3.2$$

Solving for SM and rounding off to the nearest inch:

$$SM = 7.0 \text{ inches}$$

Section 5-11

STREET LIGHTING

5-11

The relationship between the residents of the city and their unique desert environment through protection of access to the dark night sky is important for the quality of life of our residents. This lighting policy is intended to guide planners, developers and engineers on street lighting principals most beneficial to the community.

GENERAL INFORMATION

5-11.000

This lighting policy is intended to guide planners, developers and engineers on where street light lighting is most beneficial while balancing the need to limit lighting where the need is minimal due to the negative effects and cost of excess lighting. To minimize the costs and negative impacts of light pollution, lighting should:

- A. Only be on when needed
- B. Only light the area that needs it
- C. Be no brighter than necessary
- D. Be fully shielded (pointing downward)

GUIDELINES

5-11.100

The recommended lighting levels identified within this section identify the typical lighting levels that should be followed when lighting city streets. The City Engineer will make the final decision on the lighting levels that will be required (i.e., more or less lighting) based on the characteristics of the surrounding area and the proposed developments within the area. For the purposes of lighting, the city is divided into three main lighting types (Rural, Suburban and Urban):

A. **Rural areas:**

Including ESL areas as defined by the city and areas with adjacent zoning intensity of less than 2 dwelling units per acre. These areas may also include smaller locations of more intense development but maintain rural development characteristics. Generally, has Limited Street lighting focusing only on conflict points (intersections & Pedestrian crossings) and significant curves (at or below the design speed).

B. **Suburban Street Lighting:**

All other areas not otherwise specifically defined by the city (generally noted as orange in previous map). Generally, has partial lighting focusing on conflict points, significant curves (at or below the design speed) as well as moderate corridor lighting but does not require photometric analysis. Standards such as IESNA are not significantly considered.

C. **High pedestrian urban activity areas.**

Generally, has full lighting, focusing on conflict points, significant curves (at or below the design speed) as well as corridor lighting and may require photometric analysis especially at critical conflict locations such as crosswalks. Standards such as IESNA are considered in the design process.

See Appendix 5-1B – Street Lighting Policy Map that identifies the lighting level areas, within the City, that should be used as a basis of design approach. In addition to the lighting levels required along city streets within these areas, this section also defines the lighting levels required at the street intersections.

STREET LIGHTING FOR DEVELOPMENTS

5-11.200

A. **Applicability:**

1. All New Developments
2. All New city projects
3. All redevelopment projects
4. All city redevelopment projects
5. Does not include existing facilities. Existing lighting would need to be evaluated and addressed on a case by case basis by city staff through a normal budget process.
6. Requests for new lighting in existing neighborhoods should follow the process outlines in Appendix 2-1H

B. **New and redevelopment**

1. Developers of residential, commercial, industrial, public or other types of properties are responsible for the design and installation of new street lighting on streets within and adjacent to their sites in accordance with these standards and when new development is proposed for the property.
2. Street light plans shall be prepared and sealed by a licensed engineer registered in the State of Arizona.
3. The street lighting design shall be reviewed and approved by the City.
4. All new subdivisions, new roadways, and in-fill projects on existing roadways shall use LED luminaires as specified in this Section unless otherwise approved by the City Engineer. LED luminaires shall conform to the requirements in Section C.1 – LED Luminaire Requirements
5. Street lights shall be fully shielded in such a manner that light emitted by the fixture, either directly from the lamp or indirectly from the luminaire, is projected below a horizontal plane running through the lowest point on the fixture where light is emitted. External shields or reflectors to prevent up-light are not allowed.
6. The developer shall coordinate all design, electrical service criteria and needs with the utility company serving the electricity to the lighting system.
7. The developer shall conform to the latest requirements of the serving utility and pay all fees for design and energization.
Plans for street lighting shall show the locations, distance between lights, luminaire types/sizes, mounting heights, pole types, and other information that is identified in Appendix 5-1D – Street Lighting Plan Checklist.
8. The developer shall prepare the lighting system design and appropriate calculations relative to illumination levels. Illumination design should follow the Recommended Lighting Levels for City Streets.

C. **Corridor lighting**

Corridor lighting should be provided per Table 5-11.1 - Corridor Lighting Requirements.

Corridor Classification	Limited Street Lighting (Blue Area on Policy Map)		Suburban Street Lighting (Orange Area on Policy Map)	
	Lighting	level	Lighting	level
Major Arterial	No	NA	Yes	Partial
Minor Arterial	No	NA	Yes	Partial
Major Collector	No	NA	Yes	Partial
Minor Collector	No	NA	Yes	Partial
Local collector	No	NA	No	NA
Local street	No	NA	No	NA
Driveways	No	NA	No	NA

TABLE 5-11.1 - CORRIDOR LIGHTING REQUIREMENTS

1. Corridor lighting is not generally recommended for rural areas.
2. Photometric calculations are not typically required for Rural or Suburban areas.
3. Partial lighting focuses on conflict points, significant curves (at or below the design speed) as well as moderate corridor lighting but does not require photometric analysis. Standards such as IESNA are not significantly considered during the design process. Moderate corridor lighting may be provided with typical spacing as indicated by tables 5-11.2.
Full lighting focuses on conflict points, significant curves (at or below the design speed) as well as corridor lighting and may require photometric analysis especially at critical conflict locations such as crosswalks. Standards such as IESNA are considered. Emphasis is on balancing the need for lighting and minimizing the potential negative effects of lighting. For corridors that the city requests full lighting, lighting should be provided per Table 5-11. 2 – Street Lighting Recommendations.
4. No corridors are required to be fully lit unless specifically requested by the City. Full lighting is generally reserved for intersections with high conflicts, high pedestrian use and or curves.
5. Major and minor arterial streets may be continuously lit, as directed by the City, with a luminaire rating of 13,500 typical initial lumens. Photometric calculations may be required for major and minor arterial streets when requested by the City.
6. Major and minor collector streets may be continuously lit, as directed by the City, with a luminaire rating of 9,600 typical initial lumens. Photometric calculations may be required for major and minor collector streets when requested by the City.
7. Local streets may be lit, as directed by the City, with a luminaire rating of 4,500 typical initial lumens. Photometric calculations are not recommended for local streets.

Road Class	Minimum Maintained Average (fc)	Uniformity Ratio (Avg: Min)	Typical Spacing*	Pole Arrangement	Road Width**	Mounting Height	Luminaire (lumens)
Major Arterial	0.9	3.0:1	200'	Staggered	112'	34'-3"	13,500
Minor Arterial	0.9	3.0:1	225'	Staggered	80'	34'-3"	13,500
Major Collector	0.6	4.0:1	250'	Staggered	72'	27'-3"	9,600
Minor Collector	0.6	4.0:1	150'	One Side	50'	27'-3"	9,600

TABLE 5-11.2 STREET LIGHTING ILLUMINATION REQUIREMENTS

*Typical spacing is the spacing between luminaires on the same side of the roadway.

**Roadway width is the typical distance from curb to curb including any medians.

***Mounting heights are generally +/- 3 feet and uniform throughout out a corridor.

D. Intersection Lighting

1. Intersection lighting should be per Table 5-11.3 – Intersection Lighting Requirements

Street lights should be installed at conflict areas when intersecting streets are not continuously lit (i.e. isolated Intersections). Isolated intersections should be lit as shown in Table 5-11.2 Street Lighting recommendations with poles typically spaced as indicated in the table, typically resulting in 1 to 2 poles per intersection. The road classification with the highest light level should be used.

2. The intersection illumination levels of intersecting streets that are continuously lit should be greater than the intersecting streets. Non-isolated intersections should be lit as shown in Table 5-11.2 Street Lighting recommendations with poles typically spaced half the distance indicated in the table, typically resulting in 2 to 4 poles per intersection. The road classification with the highest light level should be used.
3. While field condition varies and change over time, a typical fully lit intersection design should provide lighting on and within the crosswalk areas of: Average foot-candle value of 1.2, with a 4.0:1 Avg/Min ratio.

Corridor	Intersecting Street	Blue Area		Orange Area	
		Lighting	level	Lighting	level
Major Arterial	Major or Minor Arterial	Yes	Full	Yes	Full
Major Arterial	Major or Minor Collector	Yes	Partial	Yes	Full
Major Arterial	Local collector or Local Street	Yes	Partial	Yes	Partial
Major Arterial	Driveways	No	NA	No	NA
Minor Arterial	Minor Arterial	Yes	Full	Yes	Full
Minor Arterial	Major or Minor Collector	Yes	Partial	Yes	Full

Corridor	Intersecting Street	Blue Area		Orange Area	
		Lighting	level	Lighting	level
Minor Arterial	Local collector or Local Street	Yes	Partial	Yes	Partial
Minor Arterial	Driveways	No	NA	No	NA
Major Collector	Major or Minor Collector	Yes	Partial	Yes	Full
Major Collector	Local collector or Local Street	Yes	Partial	Yes	Partial
Major Collector	Driveways	No	NA	No	NA
Minor Collector	Minor Collector	Yes	Partial	Yes	Full
Minor Collector	Local collector or Local Street	No	NA	Yes	Partial
Minor Collector	Driveways	No	NA	No	NA
Local collector	Local collector or Local Street	No	NA	Yes	Partial
Local collector	Driveways	No	NA	No	NA
Local street	Local street	No	NA	Yes	Partial
Local street	Driveway	No	NA	No	NA

TABLE 5-11.3 – INTERSECTION LIGHTING REQUIREMENTS

E. Enhanced Street Lighting Levels

1. Per the city’s discretion, higher lighting levels (above the minimum requirements) may be required (on a case-by-case basis) based on roadway curves, pedestrian activity, safety, and/or security concerns. When the City determines that higher illumination levels are required, the following lighting levels should be utilized:
 - a. Major and minor arterials: Average foot-candle value of 1.7, with a 3.0:1 Avg/Min ratio.
 - b. Major and minor collectors: Average foot-candle value of 1.2, with a 4.0:1 Avg/Min ratio.
2. Luminaires with a higher initial lumens value may be utilized for enhanced street lighting levels as approved by the City.

MATERIAL REQUIREMENTS

All new street lighting fixtures shall comply with the LED Luminaire Requirements and serving utility company’s Pre-Qualified Products List identified within this section. All light poles and mast-arm shall comply with the city pre-approved products identified within Appendix 5-1C – Pre-qualified Product List.

5-11.300

A. LED Luminaire Requirements

1. Luminaires shall be listed by a National Recognized Testing Laboratory (NRTL) as defined by the U.S. Department of Labor. The testing laboratory must be listed by the Occupational Safety and Health Administration (OSHA) in its scope of recognition for the applicable tests being conducted as required by this specification. A list of recognized testing labs for products sold in the United States may be found on the [U.S. Department of Labor's](#) web site.
2. Luminaires shall be listed and labeled by a NRTL as being in compliance with UL 1598 and suitable for use in wet locations;
3. The light source and drivers shall be Restriction of Hazardous Substance (RoHS) compliant;
4. Luminaires shall have an International Electrotechnical Commission (IEC) 529 Ingress Protection (IP) rating of IP 65 or greater for the optical assemblies of the luminaire;
5. The mounting assembly shall permit any necessary adjustment to orient the luminaire with the roadway for proper light distribution;
6. Luminaire shall have a built-in leveling indicator inside of the housing to allow for proper orientation of the luminaire;
7. Lumen maintenance at 50,000 hours and 40 degrees C based on TM-21 testing shall be 90% or greater.
8. Driver and LED modules shall be replaceable as separate units and have plug connections.
9. Luminaires shall be tested and capable of operating in ambient temperature of -7 degrees C to 50 degrees C.
10. Luminaires shall have a surge protection device (SPD) to protect from damage and failure for common and differential mode transient peak currents up to 10 kA (minimum). SPD shall conform to UL 1449. SPD performance shall be tested per American National Standards Institute (ANSI)/IEEE C62.41-2:2002 category C high exposure and ANSI C136.2-2015 10kV option. The SPD shall fail in such a way as the luminaire will no longer operate. The SPD shall be field replaceable.
11. Luminaires shall support installation of a future Electronic Control Module (ECM) for dimming and luminaire performance monitoring;
12. The housing shall be designed to allow water shedding;
13. Luminaires shall have a label that states operating voltage and current range. The label must be clearly visible on the inside of the housing;
14. A limited system warranty must be provided for the replacement or repair of the luminaire due to any electrical failure (including light source and or power supplies/drivers) for ten (10) years;
15. Luminaires shall have an electronic driver with a drive current no greater than 700mA;
16. The electronic driver shall have a rated life of 100,000 hours with a luminaire operated at an ambient temperature of 25° C (77°F);
17. Luminaires shall have a Nominal Correlated Color Temperature (CCT)
 - a. ESL areas = 2200K +/- 300K
 - b. Balance of city = 4100K +/- 300K

18. Luminaires shall have a 7-pin locking ANSI C136.41 photocell receptacle; and
19. Each luminaire shall include a photocell conforming to the following requirements:
 - a. Photocell shall have a 10-year warranty and a rated life of 20 years
 - b. Photocell shall operate at nominal 120-277V
 - c. Photocell shall have surge protection arrestor to protect the luminaires and photocell from in rush surges.
 - d. Photocell shall turn on the luminaire at 1.5fc and off by 2.25fc.
 - e. Photocell failure shall fail the fixture on.

B. POLE REQUIREMENTS

To improve efficiency, promote sustainability, reduce costs and reduce stockpile requirements; uniformity shall be encouraged and will be required on a project by project basis as determined by the City Engineer.

Standardized poles shall be used City wide basis. If a new pole type is added, an old pole type should be removed. The City typically uses poles on the approved APS "MATERIALS AND APPROVED MANUFACTURERS FOR STREET LIGHTS" list (latest version as of writing is 3/23/2009).

1. The City typically uses circular poles except in neighborhoods (page 9 of APS QPL)
2. Typical (circular) mounting height for arterials and major collectors is 32 feet above the pavement
3. Typical (circular) mounting height for local and minor collector roadways is 25 feet above the pavement
4. Typical neighborhood (square) mounting heights are 19 feet above pavement.
5. Mast arms should be 8 feet for arterials and 6 feet collectors
6. Typical pedestrian (circular) pole mounting height should be 10-15 feet above the pavement.

Character area poles may be used as approved by the City Engineer on a case by case basis but should be kept to a minimum.

DESIGN REQUIREMENTS

5-11.400

A. Photometric Calculations Requirements

Unless otherwise noted, the City only requires photometric calculations on areas that are recommended as fully lighted design areas. When a photometric lighting analysis is requested by the City, the street lighting photometric analysis report should conform to the following requirements, in addition to the requirements identified within DSPM Section 1-2.500 Reports & Other Documents:

Street lighting photometric results should be submitted with the street lighting improvement plans and intersection improvement plans submittals for City review and approval.

All photometric calculations should be performed using the illuminance method with a light loss factor of 1.0. Adherence should be noted within the submitted report.

The photometric design grid should be placed between the travel lanes in each direction of travel with a minimum of two grid lines per lane and a maximum of 10 feet between longitudinal points. Travel lanes of the street and associated locations of each photometric calculation point within the design grid should be depicted within the submitted report. When more than one grid is needed to cover different street lighting improvement areas within the project, each grid should be provided with a unique name within the submitted document.

One or more photometric calculation summary tables should be included with the submitted report and these tables should include the following, at a minimum:

1. The name of each calculation grid that the summary table covers;
2. The average illuminance value calculated for each grid;

3. The minimum illuminance value calculated for each grid;
4. The average to minimum uniformity ratio value calculated for each grid; and
5. The corresponding required values from City Wide Street Lighting Policy section with an indication that the calculated photometric values meet the required criteria.

B. Requirements for Street Lighting Plan

All improvement Plans that are proposing new or modified street lights should include the information identified within Appendix 2-1D - Street Lighting Plan Checklist.

The following General Street Lighting Notes, and the relevant APS Service Area Notes or SRP Service Area Notes should be included on the Street Lighting Plans. The most current construction notes should be included at the beginning of the Street Lighting Plans. Figure 2-1.10 – Street Lighting General Construction Notes provides the Notes at the time of this document’s adoption.

STREET LIGHTING GENERAL CONSTRUCTION NOTES

1. The Contractor shall comply with State and city statutes and ordinances.
2. The Contractor shall comply with all licensing requirements set forth by the State registrar of contractors office to perform work relating to electrical installations.
3. Prior to bid submittal, the Contractor shall examine all construction drawings and visit the construction site to become familiar with existing conditions under which they will operate, and which will in any way affect the work under the contract.
4. The Contractor shall verify dimensions at the site and immediately report differences to the city’s inspector and not proceed with work until the city inspector renders a decision.
5. The Contractor shall obtain one dry utility permit for each street lighting project, or phase if a multi-phase project, prior to construction.
6. It is the Contractor’s responsibility to contact the utility companies for coordination of the trenching; the installation of conduit and pull boxes; and the installation of electrical conductors for the street lighting system.
7. Trenches and excavation for electrical conduit and pull box installations shall be per the electrical utility company requirements. The use of a common electric utility company trench is permitted, unless otherwise directed by the electric utility company.
8. Surplus excavation shall be disposed of by the Contractor.
9. Electrical conduits used for city street lights shall be UL Rated and suitable for underground use per the electrical utility company requirements.
10. All electrical conduit sizes, locations and installations shall be per the electrical utility company’s Plans and installation requirements, except for the conduits entering light poles. The conduit from the light poles to the pull boxes shall be installed per these Plans.
11. All electrical pull box sizes, locations and installations shall be per the electrical utility company’s Plans and installation requirements. These pull boxes may be

STREET LIGHTING GENERAL CONSTRUCTION NOTES

referred to as Junction boxes or J-Boxes on the electrical utility company's Plans.

12. An 8' x 5/8" minimum size copper clad ground rod shall be installed for each electrical pull box installation adjacent to each light pole. Ground rod sizes and installations shall be per the electrical utility company's requirements and shall meet these minimum requirements.
13. Street light pole locations shall be per these Plans and the electrical utility company's Plans. If a conflict exists between these two lighting plans, the Contractor shall immediately report differences to the city's inspector and not proceed with the conflicting work until the city inspector provides direction on how to proceed.
14. Street lighting poles shall be set no closer than 2.5 feet from back of curb and 1 foot from back of sidewalk. All street lighting poles shall be located within city right-of-way.
15. Street lighting poles shall be installed plumb in two directions, ninety (90) degrees apart, and shall be adjusted to provide proper alignment to the roadway being lighted.
16. Luminaires shall be installed level and include a photocell and other lighting system components needed to be fully operational. The luminaires shall be free of dust, dirt or anything that would impair the output of the light.
17. Luminaires shall be wired or connected to match the voltage supplied by the electric utility company.
18. The Contractor shall provide a fuse holder for each power conductor inside each street light pole. Fuse holders shall be breakaway, in-line, waterproof style with 5A fuse and accessible from the pole hand hole. These fuse holders and fuses are required in addition to any fusing that the electrical utility may require in the pull boxes.
19. The Contractor shall provide all power conductors and wiring connections within the light poles. Power conductors from the luminaire down to the fuse holders shall be a minimum size of #12 AWG. The grounding conductor from the luminaire down to the ground lug, accessible from the pole hand hole, shall have green color insulation and shall be a minimum size of #12 AWG. All conductors installed within the light pole shall be copper.
20. The Contractor shall provide #6 AWG bare copper ground wire between the pole ground lug and the electrical pull box adjacent to the light pole. The Contractor shall connect this ground wire to the ground lug within the pole and the Contractor shall follow the electrical utility requirements for the connection to the ground rod at the pull box end.
21. The Contractor shall provide the necessary power conductors between the light pole and the electrical pull box adjacent to the light pole. These copper power conductors shall be a minimum size of #12 AWG, unless otherwise noted larger within these plans, and shall be connected to the fuse holder

STREET LIGHTING GENERAL CONSTRUCTION NOTES

- within the light pole. The Contractor shall follow the electrical utility's requirements for the power connections at the pull box end.
22. Street lighting poles shall be properly grounded prior to submitting a request to have the electrical circuits energized.
 23. It is the contractor's responsibility to restore all property, landscaping, paving and driveways that are disturbed during streetlight construction to their original condition in conformance with MAG Specification section 107.9.
 24. Prior to acceptance, the Contractor shall install the pole numbers on each street lighting pole, per the utility company requirements and using the pole numbers identified within the electrical utility company's lighting Plans.
 25. Prior to acceptance, the Contractor shall energize and operate the entire roadway lighting system, from sunset to sunrise for two (2) consecutive days without interruption or failure. If a luminaire or component within the luminaire should fail, it shall be immediately replaced. The developer shall be responsible for furnishing all personnel and equipment to successfully perform this test.
 26. The contractor shall guarantee all work for a period of one year from the date of final acceptance by the city Inspector, against imperfect workmanship, failure, malfunction of materials and/or equipment due to faulty or imperfect workmanship.
 27. This guarantee is to be in writing to the city at the time of issuing final acceptance. Materials and workmanship found to be defective within the warranty period shall be replaced without cost to the City.

FIGURE 5-11.1

ADDING LIGHTING TO EXISTING NEIGHBORHOODS

Residents living on public streets in areas without streetlights may petition the city to form a Streetlight Improvement District. Once a district is approved, fees are assessed by the Maricopa County Assessor’s Office. City staff will act as a resource for residents in forming a Streetlight Improvement District. However, residents are encouraged to seek advice of private counsel to assist in forming a Streetlight Improvement District.

- A. Process for New Land Divisions to Form a Streetlight Improvement District
 - 1. Land owner files a Streetlight Improvement Petition to form a Streetlight Improvement District, see Appendix 2-1A – Streetlight Improvement District Petition.
 - 2. Land owner obtains streetlight layout from appropriate utility company which is reviewed by city staff.
 - 3. Submit request and layout to city for staff and City Council review and approval.
 - 4. City staff sends approved Streetlight Improvement District request to Maricopa County Assessor for assessment.
- B. Process for Residents to Obtain New or Additional Streetlights
 - 1. Residents file a Streetlight Improvement Petition to form a Streetlight Improvement District, see Appendix 2-1A or city’s website.
 - 2. City staff reviews Petition to determine property ownership for compliance with state statute (51% must be in favor of forming district).
 - 3. Residents obtain streetlight layout from appropriate utility company which is reviewed by city staff.
 - 4. Submit request and layout to city for staff and City Council review and approval.
 - 5. If Resolution Ordering Work is approved by City Council, city staff sends request to Maricopa County Assessor for assessment.
 - 6. If substantial protest is received, the district will not be formed.

Road Classification	Policy Map Area	Minimum Maintained Average Value (fc)	Uniformity Ratio (Avg: Min)
Major/Minor Arterial	Suburban	0.9	3.0:1
Major/Minor Collector	Suburban	0.6	4.0:1

TABLE 4 INTERSECTION LIGHTING – ISOLATED

STREETLIGHT POLICY MAP

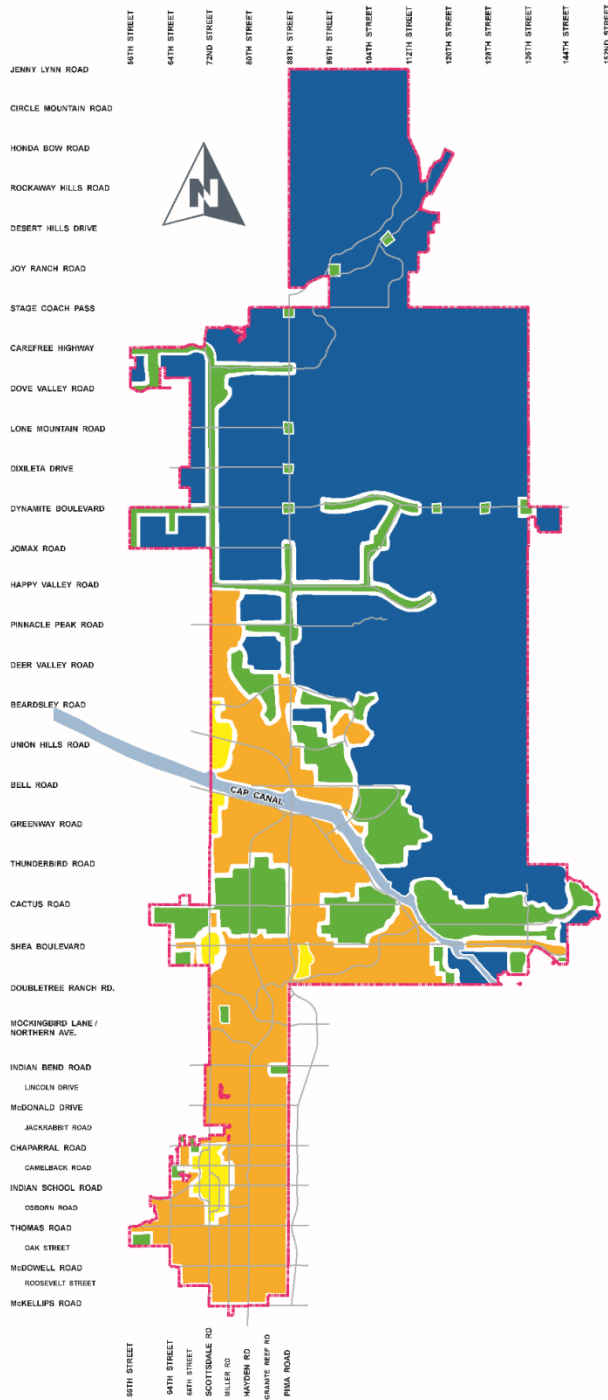

Streetlight Policy

Legend

- City Boundary
- Streets
- Pedestrian Activity Areas
- Partial Street Lights
- Suburban Street Lighting
- No Street Lights
- CAP Canal

Digital map created by: Josh Bruce

PREQUALIFIED PRODUCTS LIST

A. Luminaires

1. Cree Lighting
2. Eaton
3. General Electric

B. Poles

1. APS Round Direct Buried, 30'-6" pole length, 25 ft. above ground, galvanized
2. APS Step Round Direct Buried, 38'-6" pole length, 32 ft. above ground, galvanized
3. APS 5" Square Steel Pole Direct Buried, 38'-0" pole length, 31'6" above ground, painted.

C. Mast Arm

1. APS 20" x 6' galvanized
2. APS 3' x 8' galvanized
3. APS 8' x 8' galvanized
4. APS 2' square arm, bronze
5. APS 8'x8' square arm, bronze

D. SRP Pre-Qualified Products List

1. All lighting designs within SRP's service area must use lighting fixtures that are currently on SRP's flat billing rate schedule for the City.
2. If developer is proposing a luminaire not currently on SRP's flat billing rate, the developer must coordinate with Utility Company for the utility company to prepare a special billing rate as necessary. Refer to Appendix 2-1C for current list of approved products.

PLAN CHECKLIST

- Plans sheet size, scale, lettering, and seal/signature meet the “Improvement Plan Requirements” identified in DS&PM Section 1-2.
- The Plan set includes a cover sheet, per the “Cover Sheet Format & Information” requirements identified in DS&PM Section 1-2, and the Street Lighting Plans are clearly noted within the required Sheet Index.
- Cover sheet includes the name of the electrical utility service provider (APS/SRP) for the project area.
- The Plan set includes the “General Notes for Public Works Construction” as required in DS&PM Section 1-2.
- The Street Lighting General Construction Notes, as defined within DS&PM, have been included at the beginning of the Street Lighting section of the Plans.
- The Street Lighting Construction Notes for respective electrical utility company area (APS or SRP) are included, as defined within DS&PM, at the beginning of the Street Lighting Plans but following the Street Lighting General Construction Notes.
- The graphic scale and North arrow is present on each street lighting plan sheet.
- The street lighting design professional name, address and phone number is on Plan sheets within the Street Lighting section of the Plans.
- The Blue Stake label/phone number is on each plan sheet
- All Existing and proposed utilities shown
- Each type of proposed street lighting fixture and pole is clearly label on each plan sheet.
- The project site and adjacent parcels are clearly labeled on the Plan sheets
- The Lot lines, right-of-way lines, and utility easement lines are shown on the Plan sheets
- The street names within and adjacent to the project site are labeled on the Plan sheets.
- Existing and proposed driveway locations shown
- Dimension the following items from roadway centerline (Face of curb, R/W, existing and proposed utilities, edge of pavement, width of sidewalk)
- Top and bottom of all retention basins shown
- Retaining walls shown
- Construction notes indicating pole height, foundation (if required), mounting height, mast arm size, and luminaire (lumens).
- Provide station and offset from roadway centerline to center of all new and existing light poles.
- Show the location of the nearest existing streetlight including details of luminaire type, wattage, mounting height and pole type. Indicate station and offset to roadway centerline.
- All phasing must be shown on the plans.

SERVICE AREA MAP

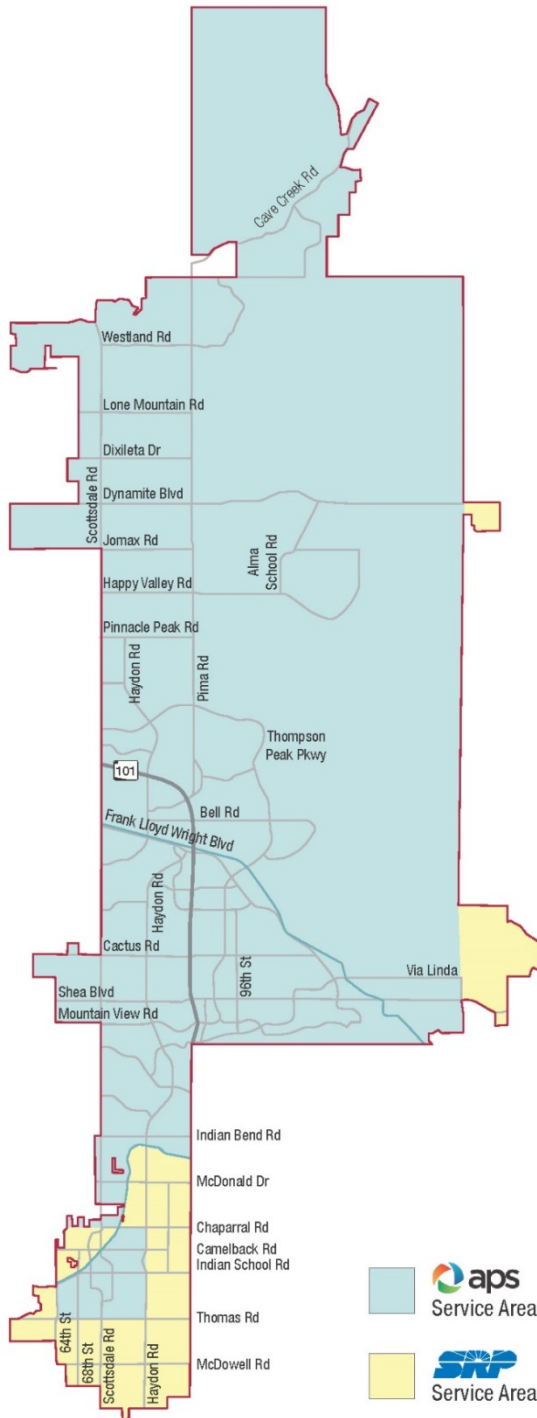

**aps/srp
Service
Areas**

DESIGN AND SUBMITTAL PROCEDURES

A. Private Development General Design and Submittal Requirements

This section identifies the design procedures and submittal steps for private development projects that are adding/relocating street lighting within city streets. Design procedures vary depending on if the project is in an APS or SRP service area. Refer to Appendix 5-11E - Map of SRP and APS Service Areas in Scottsdale to determine which electrical utility company serves the project area. All Developers should follow Appendix Section 5-11F, 1 – ITS Signals Group Coordination General Submittal Requirements and then follow the procedures of Appendix Section 5-11F, 2 or Appendix Section 5-11F, 3 depending on the applicable utility company.

1. ITS Signals Group Coordination General Submittal Requirements

In addition to the submittal(s) required by the electrical utility company (SRP and APS), an electronic copy of each submittal must also be provided to the City. Submittals shall contain the following elements:

- a. Email Subject Line: "Street Lighting Submittal - FYR" followed by the project name.
- b. Attachments: Portable Document Format (PDF) file of the Street Lighting Plans (not the entire set of project plans)
- c. Email Body: Within the body of the email, identify the following:
- d. The level of completion of the submitted Plans (Initial Plan Review (IPR); Draft Final Plan Review (DFPR); or Final Plan Review (FPR));
- e. The contact information for the people who the review comments should be sent to, including, at a minimum, the Responsible in Charge for sealing the Street Lighting Plans and the Developer's Project Manager;
- f. Project name and location information;
- g. Developer's Legal Company Name; and
- h. One of the following statements that apply:
 - i. "All street lighting fixtures being proposed in this project are on the city's pre-qualified products list" or
 - ii. "One or more street lighting fixtures being proposed on this project are not on the city's pre-qualified products list. Please refer to the attached light fixture cut sheets for more information about the different products that are being proposed."

B. City Capital Improvement General Design and Submittal Requirements

This section identifies the design procedures and submittal steps for city capital improvement projects that are adding/relocating street lighting within city streets. Design procedures vary depending on if the project is in APS or SRP service area. Refer to Appendix 2-1E - Map of SRP and APS Service Areas in Scottsdale to determine which electrical utility company serves the project area. All Consultants should follow Appendix Section 2-1G, 2 – ITS Signals Group Coordination General Submittal Requirements and then follow the procedures of either Appendix Section 2-1G, 3 or 2-1G, 4 depending on the applicable utility company

1. Net-Zero Energy Consumption Goal for Street Lighting

For the city to establish a sustainable level of energy consumption for the city's street lighting system, the city has adopted a Net-Zero Energy Consumption Goal on all city capital improvement projects. This Net-Zero Energy

DESIGN AND SUBMITTAL PROCEDURES

Consumption Goal is a key step in the city's ability to replace the existing HPS lighting fixtures on city streets to LED lighting fixtures, which utilize low energy consumption when compared to HPS lighting technology. With this goal any city project that adds one or more new lighting fixtures within the project area must also facilitate the replacement of existing HPS lightings fixtures in other parts of the city, so the net street lighting energy consumption is zero or less. The city's Capital Improvement Project Manager should coordinate the following steps with the ITS Signals Group to achieve this goal:

Calculate the total wattage of the new lights being added into the street lighting system by the Capital Improvement Plan (CIP) project. This additional wattage value, equates to the amount of energy that needs to be saved by replacing existing HPS street lights in other parts of the City.

Coordinate with the ITS Signals Group to identify the quantity and wattage of the existing HPS lights that need to be replaced, with LED lights to achieve the Net-Zero Energy Consumption Goal. This quantity of additional LED lights that the project must furnish is based on the energy saved (i.e., Wattage of the HPS lights to be replaced minus the wattage of the additional LED replacement light provided by the project).

All additional LED street lights provided by the project to meet the Net Zero Policy will be furnished only and will be provided with a quick disconnect fuse holder and fuses. These Street lights (with fuse holder & fuses) shall be furnished directly to the city and delivered to warehouse at 9191 E. San Salvador. These Street lights (with fuse holder & fuses) shall be new and delivered in manufacturer boxes with packing slips and the boxes shall be labeled "Street Lighting."

2. ITS Signals Group Coordination General Submittal Requirements

In addition to the submittal(s) required by the Scottsdale Capital Project Management (CPM) Project Manager, an electronic copy of the Street Lighting Plans at each submittal must also be provided to the City ITS Signals Group. Submittals provided to the ITS Signals Group via email shall contain the following elements:

Email Subject Line: "Street Lighting Submittal - " followed by the project name.

Attachments: PDF file of the Street Lighting Plans (not the entire set of project plans)

Email Body: Within the body of the email, identify the following:

- a. The percent level of completion of the submitted Plans;
- b. The contact information for the people who the review comments should be sent to, including, at a minimum, the Responsible in Charge for sealing the Street Lighting Plans and the Consultant's Project Manager;
- c. Project Name and Number as assigned by the city as well as the City Project Manager;
- d. One of the following statements that apply:
 - "All street lighting fixtures being proposed in this project are on the city's pre-qualified products list";
 - or

DESIGN AND SUBMITTAL PROCEDURES

“One or more street lighting fixtures being proposed on this project are not on the city’s pre-qualified products list. Please refer to the attached light fixture cut sheets for more information about the different products that are being proposed.”

3. SRP Service Area Procedures and Submittals

a. General Submittal Guidelines

Before submitting any documents to SRP, the CPM Project Manager must set-up a “business web page” within SRP’s “Land Property Management” portal. The CPM Project Manager should go to www.srpnet.com and enter his or her contact information; SRP will setup the “business web page” for the CPM Project Manager within 5 business days and contact the CPM Project Manager when setup is complete.

The Consultant Engineer must coordinate with the CPM Project Manager to complete all submittals to SRP through the “Land Property Management” portal and is responsible for confirming with the CPM Project Manager that each submittal was completed successfully.

The Consultant Engineer is also responsible for requesting copies of (or the status of) any project related documentation or information that SRP provides the CPM Project Manager. The following are guidelines for what the Consultant Engineer should request:

Approximately one month after the Consultant Engineer requests the submittal of the 30% Site Plans, the Consultant Engineer should request SRP’s response (i.e., did SRP respond with “No Conflict” or did they identify locations of existing SRP infrastructure within project site that appear to conflict with the proposed design).

Approximately two weeks after the Consultant Engineer requests the submittal of the 60% Site Plans, Consultant Engineer should request the following:

- i. Confirmation that the CPM Project Manager received the Contract from SRP;
- ii. Confirmation that the CPM Project Manager forwarded the SRP Contract on to the city’s ITS Signals Group to get it processed for signatures; and
- iii. Status of the SRP Contract (i.e., has it been signed and/or sent back to SRP).

Approximately two weeks after the city sends the signed contract back to SRP, the Consultant Engineer should request the contact information for the SRP Distribution Design Consultant (DDC) assigned to the project:

Approximately one month after the Consultant Engineer requests the submittal of the Final Signed & Sealed Site Plans to SRP, the Consultant Engineer should request a copy of SRP’s design plans (i.e., Yellow Prints).

b. 30% Design Submittal

The Consultant Engineer must coordinate and submit 30% Plans for review to both SRP and the city’s ITS Signals Group.

DESIGN AND SUBMITTAL PROCEDURES

SRP's 30% Design submittal review is primarily focused on conflict reviews of all construction elements with SRP's existing infrastructure. The 30% Plan Review will start when the 30% Site Design Plans are uploaded to SRP's "Land Property Management" portal. As part of the submittal, the Consultant Engineer should prepare a draft 30% SRP Submittal Cover Letter, which should include the following information:

- i. A brief description of the project;
- ii. Identification of where SRP should send the utility conflicts (i.e., CPM Project Manager and/or Consultant Engineer); and
- iii. A request for SRP to identify a point of contact at SRP to assist in resolving utility infrastructure conflicts.

For the city's ITS Signals Group, the Consultant Engineer should coordinate with the ITS Signals Group to identify the following:

- i. The pole number Prefix that applies:
 - ID = Street Light Improvement District (APS maintained) - city pays APS maintenance then assesses HOA fees.
 - SA = Scottsdale Owned/APS Maintained
 - SC = Scottsdale Owned/Scottsdale Maintained (SRP Service Area)
 - SS = Scottsdale Owned/Scottsdale Maintained (APS Service Area)
- ii. The lighting fixtures and light poles being proposed within the project area; and
- iii. The quantity and type of additional lighting fixtures that needed to be furnished by the project to meet the city's Net-Zero Energy Consumption Guidelines (see Section E. 1 – Net-Zero Energy Consumption Goal for Street Lighting).

c. 60% Design Submittal

The Consultant Engineer must coordinate and submit 60% Plans for review to both SRP and the city's ITS Signals Group.

During the development of the 60% Street Lighting Plans the Consultant Engineer shall coordinate with SRP (and other utilities) to resolve conflicts with the proposed street lighting design and the existing utilities identified and update the Street Lighting Plans accordingly.

The 60% Design Submittal to the city's ITS Signals Group should follow the general procedures presented in Section E. 2 – ITS Signals Group Coordination General Submittal Requirements and should include identification of the following:

- i. Street Lighting cover page with general and utility company notes;
- ii. Street lighting plan sheets indicating pole locations with stationing and offset; and
- iii. Photometric calculations, when required by Section B. 1 – Photometric Calculations Requirements. These may be submitted as exhibits to the plans submittal.

SRP's 60% Plan Review will start when the 60% Site Design Plans are uploaded to the "Land Property Management" portal. As part of the

DESIGN AND SUBMITTAL PROCEDURES

submittal, the Consultant Engineer should prepare a draft 30% SRP Submittal Cover Letter, which should include the following information:

- i. A summary of the remaining conflicts with SRP's utility infrastructure or a statement saying that all known conflicts with SRP utilities have been resolved within this submittal;
- ii. Identification of where SRP should send the contract (i.e., CPM Project Manager) and the SRP Design Plans;
- iii. A request for SRP to provide the contact information for SRP's DDC assigned to the project. The Consultant Engineer should coordinate with SRP's DDC for design plan changes. The DDC will also be able to answer contract questions, identify and coordinate new services points, and locate possible connection points (i.e., transformers) for the new service; and
- iv. If a lighting fixture is being proposed that is currently not on SRP's rate schedule with the City, then a request to add this lighting fixture to the rate schedule should be included within the letter. However, the Consultant Engineer must obtain approval from the city's ITS Signals Group prior to requesting the addition from SRP.

SRP will send the city a contract to sign once the 60% Plans Submittal is received. The Contract must be forwarded to the city's ITS Signals Group to get processed for signatures, and then the signed Contract must be sent back to SRP; SRP will not start their design until they receive a signed contract from the City.

d. 90% Design Submittal

90% Site Design Plans must be uploaded in PDF to SRP's "Land Property Management" portal for review. Prior to submittal of the 90% plans, the Consultant Engineer should undergo the following coordination activities with SRP:

- i. Coordinate with SRP's DDC on any changes with the Street Lighting design layout and start identifying possible service point locations and associated voltage levels available for powering the Street Lights;
- ii. Resolve any outstanding utility conflicts; and
- iii. Resolve any issues or concerns with the request to add a new lighting fixture type to the SRP rate schedule, if not using a prequalified product.

The CPM Project Manager should contact SRP's "Municipal Project Leader", if one of the following conditions exists:

- i. The contact info of SRP's DDC wasn't provided to the city after the 60% Site Design Plans submittal to SRP.
- ii. If the city has any concerns/questions with SRP's power distribution design for the new city lights that can't be resolved by SRP's DDC.

e. 95% Design Submittal to the city's ITS Signals Group

A 95% design submittal should be provided to the city's ITS Signals Group and shall include all items listed in the 60% design submittal in addition to the following:

- i. Dimensions and labels for all utilities;

DESIGN AND SUBMITTAL PROCEDURES

- ii. Evidence that all city comments from 60% design submittal are addressed; and
- iii. Coordination with utility company to identify electrical point of service.
- f. 100% Final Sealed Design Submittal

The CPM Project Manager needs to upload a PDF of the 100% Final Sealed Design Plans into SRP's "Land Property Management" portal for review. In addition to the plans, the preparation and submittal of a Service Request Letter may be required if a new or modified Service Entrance Section (SES) or electric meter pedestal is being requested. This Service Request Letter is required by SRP before they can submit their Yellow Prints to the City. To initiate the Service Request, the city should call SRP at 602-236-0777. To set-up the service request, the following information should be provided to SRP:

- i. Street address of the meter;
- ii. Desired voltage and service load; and
- iii. Billing address and point-of-contact.

SRP "Yellow Prints"

SRP's initial design plans are called "Yellow Prints" (SRP's design printed on yellow paper) and SRP will send them to the CPM Project Manager. SRP's may take up to 6 weeks to provide their "Yellow Prints" from the date they receive the Final Signed & Sealed Plans Submittal from the Consultant Engineer. The CPM Project Manager should to coordinate with SRP directly regarding when the SRP design plans are needed, and SRP will try to expedite their design plans on an as needed basis.

The CPM Project Manager should contact SRP's "Municipal Project Leader", if the city has any concerns/questions with SRP's power distribution design for the new city lights that cannot be resolved by SRP's DDC.

SRP will obtain necessary Utility Easements from property owners if it is needed for the project.

60% Construction

At the 60% construction phase, the Contractor has built SRP's pathway infrastructure (i.e., conduits, j-boxes, foundations for service equipment/transformers, etc.), and SRP inspects the new infrastructure, and makes necessary changes to SRP's design based on actual construction installations when developing their "White Prints".

SRP "White Prints"

SRP will send the City CPM Project Manager a revised set of design plans called "White Prints". The White Prints will have the light pole numbers, which the Contractor must use when installing light poles because the numbers are those on which SRP bases their final inspection. All city street light pole numbers that SRP energizes within Scottsdale's jurisdiction should start with the "SC" prefix.

The CPM Project Manager should contact SRP's "Municipal Project Leader", if the city has any concerns/questions with SRP's power distribution design for the new city lights that cannot be resolved by SRP's DDC.

DESIGN AND SUBMITTAL PROCEDURES

LOA (for De-energize/Reenergize Circuits)

SRP will not energize or de-energize circuits for Scottsdale's Light Poles until SRP receives an LOA from the City. To obtain an LOA, the Contractor needs to request the LOA from the City Inspector. This request should be made a few weeks in advance of needing circuits energized.

The following information should be included in all LOA requests to the City Inspector as part of a Microsoft Word document:

- i. Quantity of each type of light fixture being proposed for a city light pole;
- ii. Lumens and power load information for each type of light fixture being proposed for a city light pole;
- iii. Station/offset of each city light pole and corresponding pole number;
- iv. Copy of the SRP White Prints (sheets showing city light poles and assigned pole numbers); and
- v. Contact information (phone number & email) of the SRP Design Consultant shown on the White Prints.

The City Inspector will forward the LOA Request, and all required supporting documentation to the ITS Signals Group. The City ITS Signals Group will prepare and sign the official LOA and provide it to the City Inspector.

The City Inspector will provide the LOA to SRP via email (SRPLights@srpnet.com) after he or she agrees with the work performed.

The City Inspector should include the SRP Design Consultant (shown on the White Prints) on the email to expedite the process.

4. APS Service Area Procedures and Submittals

General Submittal Guidelines

APS requires a complete set of design plans (both PDF files & Computer Aided Drafting/Design (CAD) files) at ALL Submittal stages. During the design phase, these submittals are to be directed to APS's Governmental Liaison.

a. 30% Design Submittal

The Consultant Engineer must coordinate and submit 30% Plans for review to both APS and the city's ITS Signals Group.

APS' review of the Consultant Engineer's 30% Design submittal is primarily focused on conflict reviews of all construction elements with APS's existing infrastructure.

b. 60% Design Submittal

The Consultant Engineer must coordinate and submit 60% Plans for review to both APS and the city's ITS Signal Group.

During the development of the 60% Street Lighting Plans the Consultant Engineer shall coordinate with APS (and other utilities) to resolve conflicts with the proposed street lighting design and the existing utilities identified and update the Street Lighting Plans accordingly.

The 60% Design Submittal to the city's ITS Signals Group should follow the general procedures presented in Section E. 1 – ITS Signals Group

DESIGN AND SUBMITTAL PROCEDURES

Coordination General Submittal Requirements and should include identification of the following:

- i. Street Lighting cover page with general and utility company notes;
 - ii. Street lighting plan sheets indicating pole locations with stationing and offset; and
 - iii. Photometric calculations, when required by Section B. 1 – Photometric Calculations Requirements. These may be submitted as exhibits to the plans submittal.
- c. Service Request Letter

A Service Request Letter authorizes APS to proceed with their design based on the 60% submittal plans. This Letter is prepared by the Consultant Engineer and submitted to APS by the City.

The Consultant Engineer shall email a Draft Service Request Letter (in Microsoft Word format) in a separate email to ITS Signals Group within two weeks of submitting the 60% Street Lighting Plans to APS and the City.

The Draft Service Request Letter shall contain the following information, at a minimum:

- i. The billing address for APS's design of the street lighting power infrastructure, as provided by City Records Department;
- ii. The email addresses of the individuals at the city to whom APS should send their "Preliminary Design Plans";
- iii. A description of the project;
- iv. A summary table identifying each fixture/luminaire type, the required wattage, the total load (kW), and the station/offset for each luminaire location;
- v. The preferred voltage for the city street lighting circuits; and
- vi. The addresses of any meter locations at which metered services are needed. City street lighting circuits do not require metered service, but metering may be required for other parts of the project. As such APS wants all metering requests (signalized intersections, irrigation controllers, etc.) to be provided within the same project Service Request Letter. The Consultant Engineer should coordinate with the city to obtain the meter address needed for each meter location.

It is the responsibility of the Consultant Engineer's to follow-up with ITS Signals Group to confirm that the Service Request Letter was sent to APS and with APS to confirm that they received the Letter.

APS's "Preliminary Design Plans" Submittal

After receiving the Service Request Letter from the City, APS will start developing their "Preliminary Design Plans". The APS "Preliminary Design Plans" submittal should include the following information:

- i. APS identified points of service;
- ii. Any additional junction boxes needed;
- iii. Conduit from junction box to junction box;
- iv. Conductors from junction box to junction box;
- v. Junction box installation details to be used; and

DESIGN AND SUBMITTAL PROCEDURES

vi. Trench details to be used.

APS will also provide anticipated cost for establishing new service points and the anticipated reoccurring costs associated with energy/maintenance of the street lighting infrastructure.

The APS "Preliminary Design" submittal should be reviewed by the city and the Consultant Engineer, and any necessary changes to the design should be coordinated directly with APS.

d. 90% Design Submittal

The Consultant Engineer shall update their plans based on changes that are needed to accommodate the infrastructure shown in the APS "Preliminary Design Plans" and any subsequent coordinated changes with APS. The Consultant Engineer shall then submit an updated Service Request Letter to ITS Signals Group with the 90% lighting plans. The 90% plans shall include all items listed in the 60% design submittal in addition to the following:

i. Dimensions and labels for all utilities;

ii. Evidence that all city comments from 60% design submittal are addressed; and

iii. Coordination with utility company to identify electrical point of service.

APS will start developing their "Final Plans" as soon as they receive the city's 90% submittal and signed Service Request Letter.

APS' "Final Design Plans" Submittal

APS requires up to 12 weeks from the date they receive the city's 90% Design Submittal and city signed Service Request Letter to complete their "Final Design Plans" submittal to the city. The "Final Design Plans" submittal should be reviewed by the city and the Consultant Engineer. As part of the review, the Consultant Engineer must confirm that the Street Lighting Pole Numbers are shown and that the Contractor is responsible for installing the pole numbers on each pole. Any necessary changes to the design should be coordinated directly with the APS designer.

e. 100% Final Sealed Design Submittal

The Consultant Engineer shall update the 90% Plans as needed to accommodate any review comments, the infrastructure shown in the APS "Final Design Plans" and any subsequent coordinated changes with APS. An updated Service Request Letter must be submitted with the 100% lighting plans and this letter should include a statement at the top saying that the city agrees with the "Final Design Plans" from APS (or a revised version with coordinated changes).

When there is full agreement on APS's "Final Design Plans," APS will send them to APS Construction and they will start scheduling the work.

Chapter 6

WATER

6

This chapter provides ordinance, policy, and standards establishing design criteria for constructing and modifying water systems to be owned and operated by the city. It provides guidance on agreements, preparation of design reports and design of transmission, distribution, and fire protection systems and final plans preparation.

GENERAL INFORMATION

6-1.000

A. Ordinance Requirements

Developers shall install, at their expense, all improvements necessary to provide water service to their development. This will include any pump stations, reservoirs, transmission mains, pressure reducing valves, backflow preventers or other related facilities and the payment of all required [fees](#).

There is a program for extension of the city's water system to newly developed areas and subdivisions within the city's service area where City of Scottsdale (city) water service is available.

Refer to SRC, Sec. 49-212.

B. Design Policy

A civil engineer registered in the State of Arizona shall analyze all proposed development that is determined by the city to have an impact on the water distribution system. The effects of various flow scenarios will be examined to ensure proper sizing and layout of the proposed water system.

C. Diligence

It is strongly advised that developers and property owners verify the need for any water extensions necessary to provide service to a site and comply with the extension/frontage requirements of SRC, Sec. 49-219.

D. Available Resources:

1. [Public Records Request](#) – obtain existing utility maps and as-built drawings.
2. [SRC](#) – generally Chapters 47 through 49
3. [Maricopa Association of Governments \(MAG\) Uniform Standard Specifications and Details for Public Works Construction](#).
4. The [Scottsdale supplements to the MAG standards and details](#)
5. [City's website](#)
6. A city civil plans examiner and/or city water resources engineer can confirm the need for any required extension or condition for water service.
7. Water Resources Planning and Engineering – 480-312-5685

ENVIRONMENTAL QUALITY REQUIREMENTS

6-1.001

Maricopa County Environmental Services Department (MCESD) is required to review and approve all public water main extensions and construction of water-related facilities within the city's service area prior to the city approving the final plans. Relocation or realignment of an existing water line to resolve a utility conflict does not require County approval.

Engineering Bulletin No. 10, "Guidelines for the Construction of Water Systems" published by the Arizona Department of Environmental Quality (ADEQ) and Arizona Administrative Code, "Title 18 – Environmental Quality", contain specific requirements for submittals, approvals and notifications when extension of a public water line is proposed. Some of the provisions of these documents are outlined below. It is the responsibility of the developer and the engineer to read and comply with the applicable requirements of these documents.

- A. Prior to city approval of final plans, the developer will submit a cover sheet for the final plans with a completed signature and date of approval from MCESD.
- B. Before commencing construction, the contractor or developer will provide documentation to the city public works inspector that a Certificate of Approval to Construct (ATC) and/or Provisional Verification of General Permit Conformance has been approved by MCESD. The Public Water Supply Number Signature Form will be signed by a city water resources engineer. Refer to Section 6-1.104 for city water system information. Contact MCESD at 602-506-6935.
- C. Before building permits are issued, the developer will submit to the city public works inspector a Certificate of Approval of Construction (AOC) and/or Verification of General Permit Conformance signed by MCESD for the water line extension.
- D. Prior to Inspection Services issuing a Letter of Acceptance, the developer must deliver to the Public Works Inspector an acceptable set of full-size 4 millimeter (mil) as-built mylars of the improvements.

PRIVATE WATER COMPANIES

6-1.002

Portions of Scottsdale's municipal area are provided water service by private water companies. Figure 6-1.1 delineates those areas.

Proposed private water lines located within the city's rights-of-ways or easements will require an agreement between the city and the private water company delineating liability and maintenance responsibilities. Water line design and materials shall comply with the requirements for city water lines.

Private water companies should review and approve the construction of, and modification to, water systems within their franchise areas. The developer will submit to Plan Review written documentation that the private water company has approved facilities shown on the final plans before the city grants approval.

The city will not provide water service within private water company franchise areas and will not review private water system plans unless the work will occur within the city's rights-of-ways or easements. Applicable review fees must be paid when the city reviews private water systems plans. A note will be placed on the final plans stating that the operation and maintenance of privately owned lines is not the responsibility of the city.

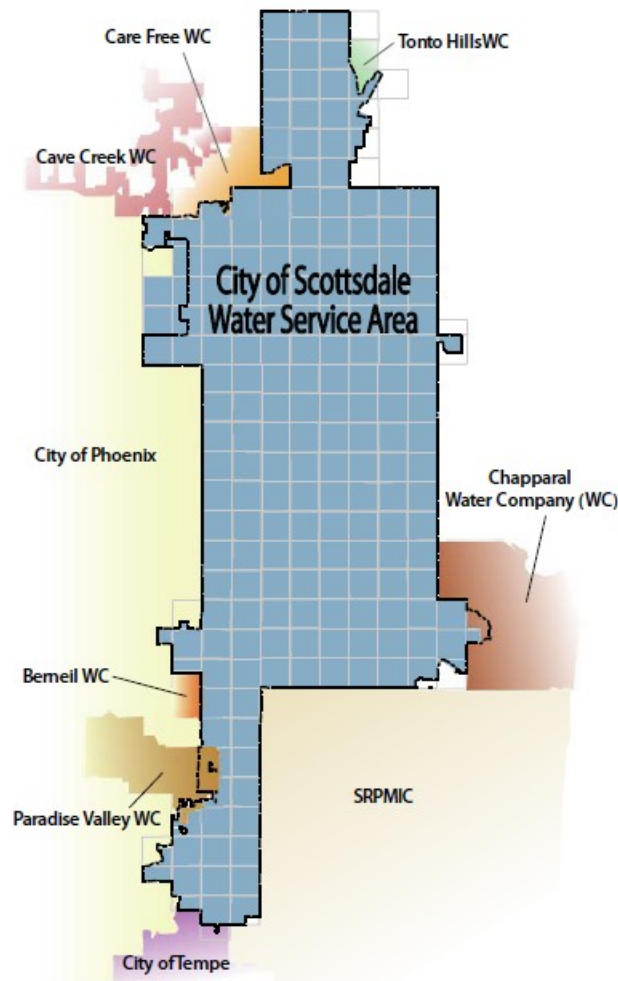

FIGURE 6-1.1 WATER SERVICE AREAS

AGREEMENTS

6-1.100

Developers and property owners who install improvements to the public water system may be eligible to request a credit, oversizing, or payback agreement with the city allowing for partial reimbursement of costs to design and construct those improvements.

Developers who construct water system improvements may receive credit for such construction per SRC, Sec. 49-82, 49-83, and 49.84. The city has specific reimbursement agreements for developers or property owners that allow them to collect line payback charges and compensation for the cost of oversizing water lines. Reference SRC, Sec. 49-212.

CREDIT AGREEMENTS

6-1.101

Credit agreements are established to compensate a developer for installing system infrastructure that has been identified in the city's Capital Improvement Plan and/or included in the most recent infrastructure improvement plan or long-range master

plan. Credit agreements are set up through the Water Resources Department and are to be identified in the developer's master plan.

OVERSIZE AGREEMENTS

6-1.102

Oversizing Agreements will allow the city to compensate developers for the cost to install a water line larger than what is minimally required to serve the development. This typically occurs where water extensions are proposed on section and mid-section line streets, or areas with projected future growth. All oversizing projects involving city funds must have an oversizing agreement and must meet all city requirements. The city can only participate in the cost of oversizing when there are sufficient funds in the capital improvements budget and the amount does not exceed the limitations set forth by the Arizona Revised Statutes, Title 34, Article 2, Paragraph 201.D. If sufficient funds do not exist, the oversized lines will be installed at the developer's cost. For more information on oversizing agreements contact the Water Resources Department.

PAYBACK AGREEMENTS

6-1.103

Developers may request a line extension payback agreement when they construct local distribution lines across frontages of parcels not currently receiving water service from the city. If the city accepts an application for a Payback Agreement, a pro-rated cost of the distribution line may be collected by the city and returned to the developer as set forth in the City Code. Line extension payback agreements are set up through the Water Resources Department. For questions or details on procedures to initiate an agreement, contact the Water Resources Department.

The [Extension Participation Program](#) may be available to single family property owners required to extend public water lines to their lot for service.

WATER SERVICE AGREEMENTS

6-1.104

The County's Water Service Agreement form should be filled out by the developer's engineer and submitted or emailed for signature to the Water Resources Department and the Solid Waste Management Division. It is the owner's responsibility to obtain these signatures from the respective city divisions and departments. The agreements will not be signed prior to the city approving the final plans. Following is the specific information regarding the Scottsdale municipal water system and the appropriate identification numbers:

Potable water system # 07-098
System Name: City of Scottsdale Water Campus
Address: 8787 E. Hualapai Dr., Scottsdale, AZ 85255

IN-LIEU PAYMENTS

6-1.105

At the sole discretion of the Water Resources Department, an in-lieu payment may be accepted as a developer contribution satisfying the frontage extension requirements of the ordinance provided:

- A. An existing or future public water line fronts, or will front, a portion of the property; and
- B. An anticipated land division and/or rezoning of an upstream or downstream property may impact the size or desired alignment of the water line, or the Water

Resources Department determines that a design cannot be sufficiently defined at time of application.

All in-lieu estimates are subject to review and acceptance by the Water Resources Department and shall include itemized amounts for design, permitting, construction, inspection, and administration based on current costs from the city's Capital Project Management (CPM) program, Master Plan, or Infrastructure Improvement Plan. In-lieu payments are to be made at the city's One Stop Shop when applying for either an encroachment or a building permit or prior to final plat approval for subdivisions.

DESIGN REPORTS

6-1.200

Water and (/or) Wastewater Basis of Design (BOD) reports for new development, redevelopment, or modifications may be required as described below.

Note that for larger planned communities, phased developments, and rezoned properties may be stipulated for a more extensive Water Master Plan to evaluate offsite water infrastructure and implications and requirements for phased planning and construction. Contact the Water Resources Department to discuss offsite and onsite requirements and the necessary content for a specific Water Master Plan.

A. When is a water and/or wastewater BOD Report required?

1. Except in those cases as described below, separate water and wastewater BOD reports shall be required to be submitted, reviewed, and ultimately accepted as "Final" by Water Resources for all new residential, commercial, or industrial development or redevelopment that may impact water and wastewater physical infrastructure, capacity, or other factors. Note that, in some cases, only a water or a wastewater BOD may be required.
2. New development or redevelopment shall not require submittal of a formal BOD report(s) when officially directed as such by Water Resources. This is typically applied in cases where there is little to no concern regarding the impact on water and/or wastewater capacity created by the new development/redevelopment, and no special engineering or planning accommodations or analysis is anticipated to be required to supply water and sewer service in accordance with city requirements.
3. Note that Water Resources may stipulate additional supplemental information in lieu of, or in addition to, a BOD report to satisfy any concerns or questions they may have.
4. New development conforming to the compound criteria listed below may not warrant submittal of a BOD report(s):
 - a. A single proposed meter and service line less than or equal to 1-inch in diameter (for residential subdivisions up to 4 homes/units with individually dedicated meters meeting these criteria qualify i.e. a proposed shared meter requires review), and;
 - b. No newly proposed public or private pipeline extensions or modifications of the city's existing public water or wastewater pipelines are required i.e. only typical domestic service line/lateral extension and connection to existing public water and sewer is required, and;

- c. No exceedance of existing building heights found in the local area (within less than a quarter mile) located at the same topographic elevation and connected to the same water pressure zone. If no comparison buildings are available for evaluation contact Water Resources for information, and;
- d. The proposed development is:
 - i. Residential or;
 - ii. Commercial if the fire hydrant(s) servicing the property is directly connected to a looped portion of the existing water distribution system or to an existing 8-inch diameter dead-end water line measuring less than 250 feet as measured from the looped distribution system connection point to the servicing hydrant. This distance is reduced to 50 feet if the dead-end line is 6-inch diameter.

Notes: When there is doubt on the applicability of these criteria confirm with the Water Resources Department; guidance on the BODs will generally be provided during the pre-application meeting; any proposed industrial development shall submit BODs.

- 5. Redevelopment conforming to the compound criteria listed below may not warrant submittal of a BOD report(s):
 - a. All proposed/required meters, and/or service lines, are less than or equal to the existing sizes (to determine the estimated revised meter size a water fixture flow rate analysis may be required), and;
 - b. There are no newly proposed zoning changes or significant changes in building use that would impact water or wastewater demands, and;
 - c. No newly proposed public or private pipeline extensions, modifications, or new connections to, the city's existing public water or sewer pipelines are required i.e. the redevelopment uses the existing water-sewer service lines/laterals and existing connection points, and;
 - d. No changes to the existing building height, and;
 - e. Minimal changes to existing building square footage i.e. less than 10%, and;
 - f. No proposed new additional or increased high water or wastewater demand features e.g. pools, kitchen, public bathroom, change to fire suppression and firefighting demand, etc., and;
 - g. The proposed development is:
 - h. Residential or;
 - i. Commercial if the fire hydrant(s) servicing the property is directly connected to a looped portion of the existing water distribution system or to an existing 8-inch diameter dead-end water line measuring less than 250 feet as measured from the looped distribution system connection point to the servicing hydrant. This distance is reduced to 50 feet if the dead-end line is 6-inch diameter

Notes: When there is doubt on the applicability of these criteria confirm with the Water Resources Department; guidance on the BODs will generally be provided during the pre-application meeting; any proposed industrial development shall submit BODs.

- B. Are there different stages of the water and sewer BODs and at what development stage are they typically submitted?
1. Generally, and when required, preliminary BODs are required to be accepted during rezoning.
 2. Generally, and when required, final BODs are required to be submitted and approved during the preliminary plat (PP) case or development review (DR) case prior to approval by the Development Review Board (DRB).
 3. Note that Water Resources may stipulate additional supplemental information in lieu of, or in addition to, a BOD report to satisfy any concerns or questions they may have.

PRELIMINARY BASIS OF DESIGN REPORTS

6-1.201

The requirement for Preliminary Basis of Design Reports will be indicated on the application checklist when required for a case submittal (zoning, preliminary plat, development review, etc.). The Preliminary Basis of Design Reports must be reviewed and accepted by the Water Resources Department prior to progressing Preliminary basis of design reports (BODs) will evaluate a site's existing and proposed water and fire demands to determine if adequate supply is available or if offsite infrastructure is required.

A. Preliminary BOD Report Format

The Preliminary BOD report(s) shall generally include the following items:

1. Basic text description of existing conditions, proposed development and relevant details, and proposed utility modifications.
2. Fire hydrant flow test (Refer to Section 6-1.405)
3. Determination of required fire flow (Refer to Section 6-1.501)
4. Preliminary site/utility plan showing the following:
 - a. Proposed building(s) and details: units, square footages, finished floor height, etc.
 - b. Onsite water line layout with relevant appurtenances and site features e.g. water meter(s)-domestic and landscape, domestic backflow preventer, fire lines and hydrants, etc.
 - c. Existing utilities to the extent possible to demonstrate appropriate water or sewer routing
 - d. Proposed connection to existing water and sewer (extend from building)
 - e. Any proposed new utilities or modifications, especially water and sewer
 - f. The applicant should only show information that has been field verified or gone through preliminary design, i.e. no purely conceptual layouts.
5. Water or wastewater demand calculations per DS&PM.
6. A hydrant water flow and residual pressure test conducted as close as possible to the development to verify distribution system capacity. Note: this test needs to be scheduled through, and witnessed by, the appropriate city staff.
7. Any additional analysis determined necessary by Water Resources will generally be discussed in the pre-application meeting but may also be required after the preliminary BOD submission and may include requirements to complete tasks such as hydraulic analysis/modeling and offsite analysis so that any resulting requirements can be accurately stipulated.

8. Note that Water Resources will require revisions and resubmission of preliminary BODs that do not meet the necessary requirements.

B. Report Submittal Requirement

Digital submittal of the BOD Report is preferred. If submitting hard copies, two copies of the Preliminary BODs shall be included with the project's case submittal. A copy will be available for the developer upon review or acceptance by the Water Resources Department.

FINAL BASIS OF DESIGN REPORTS

Final Basis of Design Reports must be reviewed and accepted by the Water Resources Department prior to approval by the DRB. Final Water BODs shall provide an analysis of a development's impact on the local water distribution system and verify conformance with city requirements. These reports are reviewed and accepted by the Water Resources Department then utilized by Plan Review as support for their review of the formal submitted construction drawings/plans. The report's objectives are to demonstrate the following (as applicable):

1. Design conformance with the city's current Integrated Water Master Plan
2. Prove that there are no hydraulic or technical limitations or deficiencies with the proposed design.
3. Conformance with city's design and development criteria and standards

The Final BODs shall generally include the following items:

1. All relevant information required for a preliminary BOD as-noted above but updated to reflect final design status.
2. An updated hydrant flow test if the previous applicable flow test is more than 1 year old.
3. Water and sewer hydraulic modeling information and results as detailed below.
4. Updated Final site/utility plan with the elements described under the preliminary BOD section above.
5. Any information related to comments or items Water Resources noted or required on the approved preliminary BOD (if one was submitted)
6. Note that Water Resources will require revisions and resubmission of Final BODs that do not meet the necessary requirements.

A. Design Policy

A Professional Engineer (civil or sanitary) registered in the State of Arizona must analyze a new development's impact on the city's water system. The effects of multiple scenarios shall be evaluated to ensure that sufficient water supply is available to meet the needs of that development and that the proposed water system layout/design is adequate. The BOD Report shall provide supporting map detail to serve as a master utility plan for the project.

B. General Final BOD Report Format Guidelines

1. Digital submissions of all documents are preferred as single combined and indexed Portable Document Format (PDF) files.
2. If hard copies are submitted, then two BOD report copies shall be submitted as letter-sized (8 1/2 x 11) and comb bound.
3. Provide a table of contents.

6-1.202

4. Maps and other supporting materials shall be 11X17 and attached as an appendix at the end of the report.
5. Reports must be sealed, signed, and dated on the cover by a Professional Engineer (civil or sanitary) currently licensed to practice in the State of Arizona.

C. Report Cover & Vicinity Map

Covers shall include:

1. The development's name, full address, and case number.
2. The developer/owner's name, address, and phone number.
3. The engineer or design firm's name, address, and phone number.
4. The original BOD submittal date and any subsequent revision dates.
5. A vicinity map to identify the project's location with respect to major cross streets and city quarter-section (alternatively this can be placed on the first page of the report after the TOC).

D. Introduction

1. Summarize the proposed development including the number of residential units, square footages of non-residential development and intended use, and related site improvements.
2. Summarize any previous site development.

E. Existing Conditions

1. State the existing zoning and land use.
2. Describe the existing topography, vegetation, and landform features.
3. Include a description of existing utilities in the vicinity.
4. Summarize and attach the results of a recent certified hydrant flow test of the existing water system. Refer to Section 6-1.405 for requirements.
5. Include a listing of any existing site water meters including size, location, and use for fee credit purposes.

F. Proposed Conditions

1. Describe the proposed connections to the city's water system and extension of any water lines into the site.
2. Describe the project's location within the appropriate waterzone(s) and show any boundaries.
3. Indicate second sourcing for all water extensions when necessary to meet requirements of the Fire Department or Water Quality Division of the Water Resources Department.
4. Determine the required fire flow referencing the city's current adopted Fire Code (also refer to section 6-1.501).

G. Required Computations & Hydraulic Modeling

1. Include a scour analysis when crossing washes with flow greater than 499cfs.
2. For required hydraulic modeling determine an appropriate site-specific pump/supply curve(s) or hydraulic grade line to simulate the existing distribution system pressure or flow versus pressure. This supply curve or grade line shall be developed by using the required hydrant flow test as the base data and applying necessary adjustments. The hydrant flow test data shall not be used to directly create the supply curve or grade line unless certain conditions

are met. The necessary process to develop the design system supply curve or grade line from the hydrant test results is described in Section 6-1.405.

3. Water demands shall generally be determined based on the unit demands in gallons per minute (gpm) listed in Figure 6-1.2, or as accepted or directed by the Water Resources Department, or as described within this chapter. The Water Resources Department reserves the right to require the use of potentially higher water demand peaking factors or directly apply demand flows for developments if deemed justified e.g. some restaurants or specialty developments.
4. Computer hydraulic modeling shall use H2ONET, WATERCAD, or EPANET software, or other Water Resource Department approved software.
5. In addition to network diagrams clearly present all inputs, details, and analysis output in organized tables.
6. Include all relevant hydraulic network diagrams listed for each of the following required hydraulic analysis scenarios:
 - a. Model Scenario 1: Average day demand in gpm at all demand nodes. (Refer to Figure 6-1.2)
 - b. Model Scenario 2: Peak hour demand in gpm at all demand nodes. (Refer to Figure 6-1.2 and Section 6-1.404 for peak hour demand)
 - c. Model Scenario 3: Maximum day demand in gpm at all demand nodes with worst case fire flow (Refer to section 6-1.501 describing fire flow determination. Refer to Figure 6-1.2 and Section 6-1.404 for maximum day demand)
Requirements:
 - i. The determined fire flow must be applied to the single worst-case location in the proposed system where fire flow will be required. Typically, this is the furthest and/or highest point from the main water supply connection. If not clear what the worst-case fire flow demand point is, the fire flow shall be applied to each potential point in the model until the worst-case point is determined.
 - ii. A minimum of 30 pounds per square inch (psi) must be maintained at the worst-case hydrant supply line tee/tap under this condition with a simultaneous minimum of 15 psi maintained at all domestic demand nodes (i.e., at the highest finished floor elevation and post service line and appurtenances) (Refer to scenario 4 for guidance on modeling the service line up to the demand nodes).
 - d. Model Scenario 4: Maintain the minimum domestic service pressure at the worst case domestic demand node (location/elevation) under normal daily operating flow conditions termed henceforth as the *Initial Service Line Design Flow*.

Notes: A minimum of 50 psi must be maintained at the highest proposed finished floor elevation to be served, for the worst hydraulic case domestic demand node, while applying the Initial Service Line Design Flow to the node. Typically, this will be the demand node with the lowest modeled pressure in the previous scenarios. The engineer shall define the service line

details, demand node location, and determine normal daily operating hydraulic conditions/criteria as follows:

- i. Demand point location: the furthest, highest (i.e. worst case hydraulic metered node). If the service line distances and building heights are unknown, the demand node shall be located at the geometric center of the lot at elevation 12 feet above the planned finished floor elevation for single family residential. Otherwise a typical highest finished floor elevation for the development type shall be used.
- ii. Initial Service Line Design Flow: 1) Estimate the average number of water fixtures served by the subject node; 2) Use the 2015 International Plumbing Code, Appendix E, Table E103.3(2)-total load values and Table E103.3(3) to determine the normal operating flow rate; 3) Add 10 gpm minimum to the normal operating flow to account for either a hose bib or a single irrigation sprinkler zone or estimate a higher applicable intermittent or constant base flow; 4) Apply a 1.5 safety factor to the resultant total flow rate to obtain the Initial Service Line Design Flow. Note that this flow also factors into meter sizing, refer to section 6-1.416 Service Lines and Meters.
- iii. Determine the required service line and appurtenance sizing: If the sprinkler system and the domestic uses are metered through a shared meter use the greater of the resultant flow in step above, or the required fire sprinkler flow. Refer to the applicable Fire Code for sprinkler system flow and pressure requirements. Refer to section 6-1.404 Design Flows and Head Loss for design criteria on service lines.
- iv. Model pressure losses between the service tap and the demand node: Determine the losses through the water meter and the pressure reducing valve for the resultant flow and sizing from the step above. A combined 10 psi or greater loss shall be used for meter and pressure reducing valve (PRV) in scenario 4. A 5 psi or greater loss shall be used for the meter and PRV in other modeled scenarios. The service pipe friction loss portion will be per its length and diameter as included in the model.
- v. All other demand nodes in the network, other than the worst-case node shall be assigned their corresponding peak hour total use demand per Figure 6.1-2 and Section 6-1.404 during this scenario.
- vi. No fire flows are to be applied for this scenario.

H. Network Diagrams

1. Network Diagram 1: Describe the Physical Modeled Network
Refer to Sections 6-1.300, 6-1.400, and 6-1.500 and their related subsections for water network design requirements.
Present all the nodes, valves, pipes, tanks, hydrants, and pumps within the network and present the following:
 - a. Network components with IDs
 - b. Existing distributions system pipelines (label as existing) and connection to the proposed system

- c. Complete proposed water system, including:
 - d. Each/all individually metered service lines ending in a demand node
 - i. Irrigation connections with demand nodes (show both dedicated metered lines and where shared with the domestic service line post-meter)
 - ii. Fire sprinkler riser connections with demand nodes (typically dedicated connections are used for developments other than single family residential)
 - e. Elevations (ft.)
 - f. Pipe lengths (ft.)
 - g. Friction head loss coefficients used
 - h. Pipe/valve diameters (in)
 - i. Point of any changes in pipe diameter
 - j. Valve types and positions (open/closed/modulating)
 - k. Tanks: working volumes (gal), heights (ft.), diameters (ft.)
 - l. Pump curves (3-point min) or hydraulic grade line (HGL)
 - m. Note: Developments supplied from the city's water distribution system should be modeled as a pumped supply using a pump curve developed from the required hydrant test to simulate the dynamic flow vs. pressure supplied from the water distribution system. Alternatively, differing supply HGLs derived from the flow test results can be used for the different modeling scenarios.
 - n. Provide all valve, tank, pump, and system settings (levels, pressures/control set points, valve open/close/modulation rates and settings, valve coefficients, initial conditions, etc.)
 - o. Static system supply pressure (if supply is from system, develop pump curve or HGL from hydrant test)
- Shows all numerical units or provide a legend that indicates the units used
2. Network Diagram 2: Describe the Specific Demand Scenario
 - a. Label the figure with the title of specific modeling scenario
 - b. Indicate the demand (gpm) being applied to each applicable node for the scenario
 - c. Demand nodes shall include all applicable demands for the defined scenario including domestic use (indoor), irrigation (outdoor), fire sprinkler or hydrant, etc. If a node is a summation of more than one demand type describe this in a notes column in the associated tables
 - d. Provide all valve, tank, pump, or system settings that are specific to the modeling scenario
 - e. Shows all units or provide a legend that indicates the units used
 3. Network Diagram 3: Present the Scenario Analysis Results
Label the figure with the title of the specific modeling scenario and present the following output:
 - a. Node pressures (psi or HGL elevation)
 - b. Pipe flow (gpm)
 - c. Flow direction arrows

- d. Pipe flow velocity in feet per second (fps)
- e. Each pipe segment’s head loss rate (ft. /1,000ft or psi/ft.)
- f. PRVs: Upstream and downstream pressures (psi or HGL elevation)
- g. Tanks: Inflow and outflow (gpm)
- h. Shows all units for the values presented or provide a legend on the diagram page that indicates the units used

AVERAGE DAY WATER DEMANDS ⁽¹⁾							
IN GALLONS PER DAY (GPD) ⁽²⁾				IN GALLONS PER MINUTE (GPM) ⁽²⁾⁽³⁾			
Land Use	Inside Use	Outside Use	Total Use	Inside Use	Outside Use	Total Use	Units
Residential Demand per Dwelling Unit							
< 2 dwelling unit per acre (DU/ac)	208.9	276.7	485.6	0.30	0.39	0.69	per unit
2 – 2.9 DU/ac	193.7	276.7	470.4	0.27	0.39	0.66	per unit
3 – 7.9 DU/ac	175.9	72.3	248.2	0.25	0.11	0.36	per unit
8 – 11.9 DU/ac	155.3	72.3	227.6	0.22	0.11	0.33	per unit
12 – 22 DU/ac	155.3	72.3	227.6	0.22	0.11	0.33	per unit
High Density Condominium (condo)	155.3	30	185.3	0.22	0.05	0.27	per unit
Resort Hotel (includes site amenities)	401.7	44.6	446.3	0.56	0.07	0.63	per room
Service and Employment							
Restaurant	1.2	0.1	1.3	1.67E-03	1.39E-04	1.81E-03	per square foot (sq.ft.)
Commercial/Retail	0.7	0.1	0.8	9.73E-04	1.39E-04	1.11E-03	per sq.ft.
Commercial High Rise	0.5	0.1	0.6	6.95E-04	1.39E-04	8.34E-04	per sq.ft.

AVERAGE DAY WATER DEMANDS ⁽¹⁾							
IN GALLONS PER DAY (GPD) ⁽²⁾				IN GALLONS PER MINUTE (GPM) ⁽²⁾⁽³⁾			
Office	0.5	0.1	0.6	6.95E-04	1.39E-04	8.34E-04	per sq.ft.
Institutional	670	670	1340	0.94	0.94	1.88	per acre
Industrial	873	154	1027	1.22	0.22	1.44	per acre
Research and Development	1092	192	1284	1.52	0.27	1.79	per acre
Special Use Areas							
Natural Area Open Space	0	0	0	0.0	0.0	0.0	per acre
Developed Open Space – Parks	0	1786	1786	0.0	2.49	2.49	per acre
Developed Open Space – Golf Course	0	4285	4285	0.0	5.96	5.96	per acre
Notes:							
(1) These values shall not be used directly for service line or water meter sizing.							
(2) Gallon per day values are provided for reference only. The instantaneous gallon per minute flow rates presented are intended for use in the required hydraulic modeling scenarios. The gpm values assume a 12-hour active water use period per 24-hour day. In large or specialty developments or master plans the hydraulic analysis criteria and parameters should be discussed with the Water Resources Department. Seasonal peaking should also be considered. Upon review, the Water Resources Department reserves the right to designate flows to be used in hydraulic modeling scenarios that may be different from those presented here.							
(3) The hydraulic modeling peaking factors used in select modeling scenarios are to be applied to the gpm values shown here. Max day and peak hour peaking factors can be found in Section 6-1.404.							

FIGURE 6-1.2 AVERAGE DAY WATER DEMANDS

I. Summary

1. Summarize the proposed water improvements stating that all the city's design standards and policies have been met or note why the developer is requesting any variance or exception.
2. Include a brief project schedule indicating the proposed start and completion of the development's improvements.
3. State any intent to request a credit, oversize or payback agreements along with a description of the applicable water infrastructure.

J. Supporting Maps

1. Include a scaled site plan showing all existing and proposed utility lines and all existing and proposed improvements. Provide separate maps if site demolition involves significant removal of existing utilities and improvements.
2. Screen existing topography and clearly label all existing and proposed contours or provide spot elevations with sufficient information to evaluate pipe cover.
3. Indicate locations and sizes of proposed meters (domestic and landscape), backflow preventers, fire lines and fire hydrants.
4. Show, dimension and label all property lines, rights-of-way, tract and easement lines.
5. Indicate any water zone boundary lines corresponding to the topography.

K. Submittals

1. Electronic BOD report submittals are preferred for both preliminary and final. Electronic submittal – reports may be electronically submitted following the [digital plan submittal processes](#).
2. Counter submittal – reports stipulated to be accepted by the Water Resources Department prior to submittal of improvement plans, shall be submitted to the One Stop Shop to the attention of the Water Resources Department or may be submitted electronically. Counter submittals require three copies of the report in addition to any previously redlined reports.

ADDITIONAL INFORMATION

Information regarding report requirements and the city's water distribution system may be obtained by contacting the Water Resources Department at 480-312-5685.

6-1.203

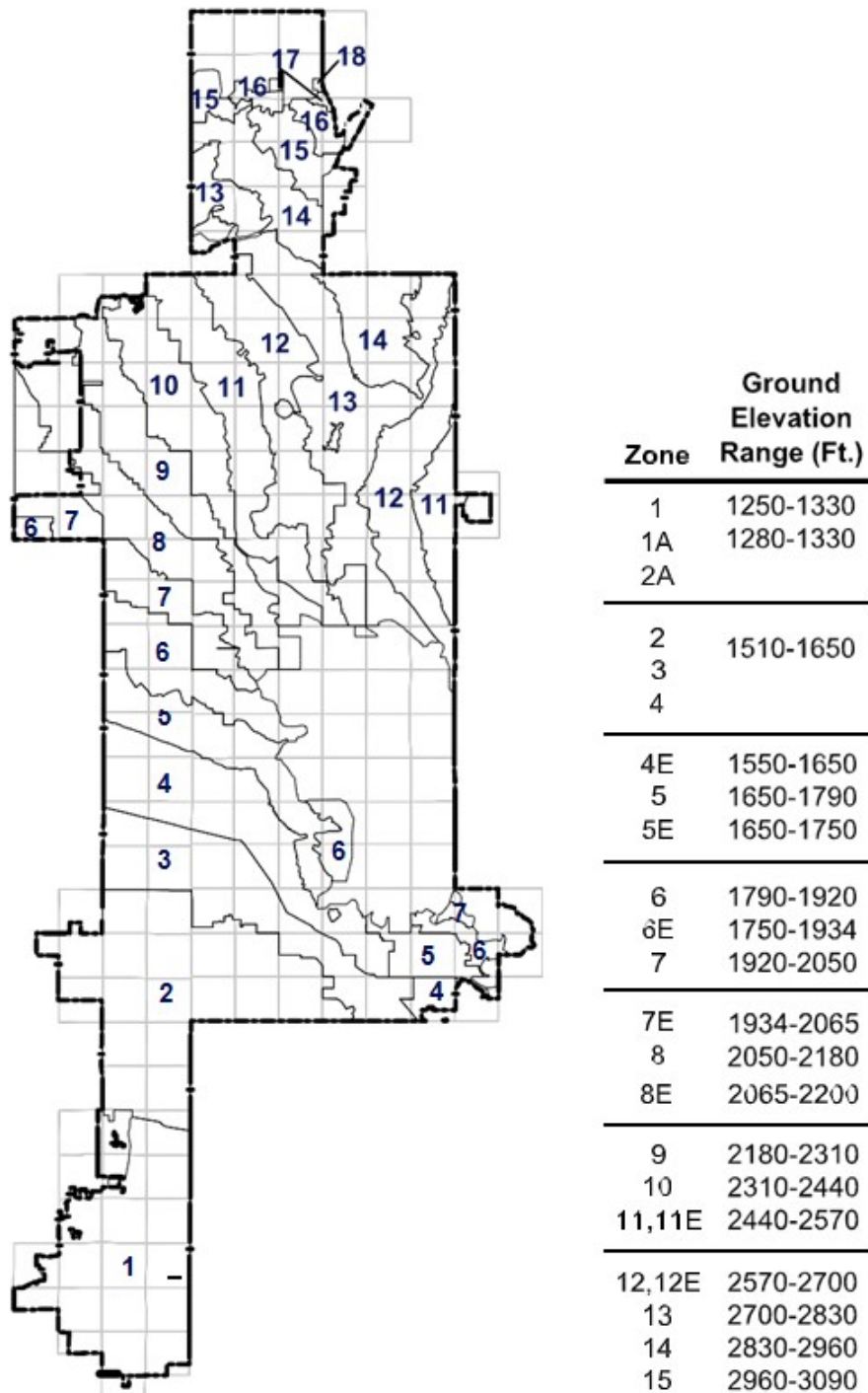

6-1.3 CITY PRESSURE ZONE MAP

WATER FACILITIES

6-1.300

Water facilities (wells, reservoirs and booster pump stations) are typically designed and constructed by the city through its Capital Improvement Program. Developers needing to construct water facilities should contact the Water Resources Department

and request a meeting. The city will address design issues, the review process for facilities and any potential city cost participation.

Water facilities will be located on a tract or a lot dedicated to the city (conveyed by a general warranty deed) and accompanied by a title policy in favor of the city.

WELLS

6-1.301

The Water Resources Department will be notified of any proposed well drilling. Under the Arizona Groundwater Management Code, the Arizona Department of Water Resources (ADWR) regulates all groundwater wells in Arizona. The Water Resources Department will not support the drilling of a private well when public water is available within 660 feet of the property.

Additional information is available from [ADWR](#) at 602-771-8500.

RESERVOIRS

6-1.302

Storage facilities must provide emergency fire protection and be designed to maximize the efficient use of water production wells and pumping facilities. Therefore, storage in each designated service area will exceed the following criteria:

Three hours fire flow reserve plus 25% of the maximum day demand (per Figure 6-1.2, use gpd value).

BOOSTER PUMP STATIONS

6-1.303

Booster pumps will be designed as required to maintain adequate pressure for domestic and fire protection water supply.

A preliminary design report must be prepared and submitted to the One Stop Shop for review and acceptance by the Water Resources Department prior to submittal of improvement plans. This report shall outline the type of equipment and controls proposed for the station along with the proposed hydraulics. A final design report and project specifications prepared by a registered civil engineer licensed in the State of Arizona must be accepted by the Water Resources Department prior to approval of the improvement plans.

TRANSMISSION & DISTRIBUTION SYSTEMS

6-1.400

A. Ordinance Requirements

Water mains shall be extended to provide water service upon development of a property if an approved source is within 660 feet of the nearest property line of the development. Individual properties that are not within 660 feet of the public water distribution system have the option to extend the public water system, drill a separate well for each individual property, or haul water. Refer to SRC Sec. 49-75.

The city requires water mains to be installed along the entire length of the property line frontage of that property being developed. The property line frontage is defined as that portion of a parcel of property that abuts a street, easement, or public rights-of-way. If a parcel to be developed has more than one frontage, improvements shall be installed along all frontages per SRC Sec. 49-212.

B. Design Policy

The city may require the extension of water lines along a frontage, or through a subdivided parcel, to the boundary where future extension of the water line is

possible, providing a point of service to adjacent properties, or as determined necessary by the city.

Reconstruction of residential or commercial structures requires compliance with all current ordinances and design guidelines relating to water line extensions, main sizing, and service lines.

Each lot will have safe, reliable, and potable water in sufficient volume and pressure for domestic use and fire protection. This shall be verified by the engineer, in part, by performing a flow and pressure test of that part of the potable system to be extended or connected to. The flows and pressure must meet minimum requirements for domestic and fire flow per Section 6-1.501. A statement verifying this shall be placed on the cover sheet of the final plans.

The city's water distribution system operates on a grid system. Minimum line size requirements for this grid are as follows, unless otherwise approved by the Water Resources Department:

1. Mile and half-mile alignments must be a minimum of 12 inch.
2. Quarter mile alignments must be a minimum of 8 inch.
3. Water lines located in the city's county service area must be a minimum of 8 inch unless otherwise approved by the Water Resources Department.
4. All other alignments must be a minimum of 6 inch.

The grid system and frontage requirements may be reevaluated through a master planning process where density, topography and other environmental features are considered. Upon acceptance of a master plan, detailed design reports for each developing parcel within the master planned area are required. Acceptance of the detailed design report, complying with the accepted master plan, provides a variance from the normal grid and water line frontage requirements.

The city maintains several pressure zones and care must be taken to identify boundary conditions when designing near a zone line. Refer to Figure 6-1.3 for water pressure zone boundaries. Static water pressure tests will be taken on a fire hydrant located on each leg of the existing water system where interconnections are proposed. Refer to Section 6-1.405.

C. **Design and Construction Standards and Details**

The engineer should be familiar with the MAG Uniform Standard Specifications for Public Works Construction and the City of Scottsdale (COS) Supplement to MAG Uniform Standard Specifications for Public Works Construction, including all applicable Standard Details. These documents contain construction-related specifications and details that impact the design of water systems including trenching, bedding, backfill and pavement replacement, etc.

MATERIALS

- A. Water distribution lines are 6 inches through 12 inches in diameter and shall be ductile iron pipe (DIP) with a minimum pressure class of 350.
- B. The city does not allow 10-inch, 14 inches, or 18-inch water lines for new construction.
- C. Water transmission lines are 16 inches and larger, and may be DIP, mortar lined steel, steel cylinder pre-tensioned pipe, or an approved equal. The pressure class will be verified with the Water Resources Department.

6-1.401

- D. The use of American Water Works Association (AWWA) C-900 polyvinyl chloride pipe (PVC) is prohibited in the Scottsdale public water system.
- E. Fire line services 4 inches and larger shall be constructed of DIP, class 350. Fire line services 3 inches and smaller shall be constructed of type K, soft copper.
- F. All ductile iron water lines are to be specified with polyethylene wrapping. Designs specifying the installation of other acceptable metallic pipe materials will require soil testing in accordance with procedures of the American DIP Research Association. Such tests shall be submitted to the city with the final plans submittal to determine if cathodic protection is required in the design.
- G. Polyethylene locating tape (color coded blue) will be placed above all public water lines.
- H. Design calculations for wall thickness will be required in cases where pipelines could be subjected to heavy external loads. These include, but are not limited to, pipelines crossing under storm drain (SD) lines greater than 36 inches in diameter, pipelines in the roadway alignment that would be exposed to heavy construction vehicle loads prior to paving, and installations exceeding the pipe manufacturer's maximum depth of bury.

SYSTEM LAYOUT

6-1.402

- A. To provide appropriate water pressure, water circulation and redundancy, all new water mains must be designed in a looped configuration, providing a minimum of two sources that can be isolated by a gate valve, except as provided for in Section 6.1-403.
 - 1. In general, water distribution and transmission lines will be on the north and east side of the street, under the drive lane or as otherwise approved by the Water Resources Department.
 - 2. The Water Resources Department will only replace standard black asphalt and grey concrete when repairing water lines. Any water lines located under colored concrete, pavers, or other specialty paving (except at crosswalks) shall require prior approval from the Water Resources Department. In such cases a note shall be placed on the subdivision plat stating that any decorative pavement disrupted as a result of maintenance to the city's water and/or sewer system shall be the responsibility of the property owners to repair or replace.
 - 3. All water lines will be aligned parallel to property lines or street center lines, except as noted in paragraph 7 below.
 - 4. Water lines shall not be located within 10 feet of a building or retaining wall without providing additional protection. Additional protection shall include placing the water line in a sleeve or modifying the footing to prevent damage in the event of a water line break.
 - 5. Design joint deflection shall not exceed 4 degrees for water lines 12 inches and smaller in diameter and 2½ degrees for water lines greater than 12 inches in diameter. Curved water lines are permissible where the individual joint deflection does not exceed the above criteria.
 - 6. For purposes of horizontal separation, SDs and non-potable water lines shall be treated as sewer lines.

7. Developments with numerous curved streets will be discussed with the Water Resources Department to decide whether the city will consider a design report with water and sewer layouts in accordance with the following criteria:
 - a. Water and sewer mains will be placed under the paved section of the roadway within the area from back of curb to back of curb.
 - b. All water mains must maintain 3 feet horizontal clearance to dry utilities.
 - c. The water main and sewer main will run parallel to each other with 9 feet of separation to the pipes centerlines to maintain 6 feet of clearance at manholes. Lines may cross the street centerline.
 - d. Deflections in the water line shall be designed to nominal fitting angles within standard tolerances and will occur at the same locations where the sewer line is deflected.
8. Hydrants, meters, blow-offs and valves shall not be in washes, detention areas, retention areas, driveways, or sidewalks.

Refer to Section 7-1.402 for related sewer criteria. The above criteria will be consistently and uniformly applied throughout each phase, parcel, or unit of a development.

- B. Water lines in commercial, multi-family and industrial developments should be located under driveway areas within a 20-foot wide water line easement. The easement shall not extend under parking areas or allow the encroachment of any permanent structures for maintenance purposes. In developments where other dry utilities, or private sewers are to occupy the same driveway, Plan Review may accept a 12- or 16-foot wide water line easement provided an adjacent public utility or access easement provides for a minimum 20-foot overall width. Dry utilities and private sewers will not be allowed to run parallel within the easement.

DEAD-END LINES

6-1.403

Terminal water lines must comply with the following:

- A. The maximum length for a dead-end water distribution line, 8-inch diameter to 12-inch diameter, will be 1,200 feet in length.
- B. Dead-end lines 1,000 feet or less may be 6 inches minimum in diameter provided adequate pressure and fire flow rates are maintained.
- C. Dead-end lines for water transmission lines 16 inches and larger, exceeding 1,200 feet in length must be approved by the Water Resources Department.

Capped dead-end lines will be fitted with a flushing pipe per MAG Standard Detail No. 390, Type "B", or a flushing assembly per COS Standard Detail No. 2383, or a fire hydrant to allow periodic flushing of the lines. Flushing devices shall not be in washes, detention areas, retention areas, sidewalks, driveways, or paved areas. Valves on dead-end lines that may be extended shall be provided with two full pipe lengths between the valve and the plug for lines larger than 12 inches and 1 full pipe length for lines smaller than 12 inches.

DESIGN FLOW & HEAD LOSS

6-1.404

The ultimate design flow within the city's water transmission and distribution system will be based on the city's current Integrated Water Master Plan. Water demand for each development will be calculated using the average day demands, as shown in Figure 6-1.2, to ensure that the existing distribution supply is sufficient. Designs will include all necessary improvements, including booster pumping stations, reservoirs, lines and appurtenances to meet the system's ultimate demand.

- A. The four hydraulic modeling scenarios detailed in 6-1.202 will demonstrate that the system is adequately designed.
- B. Select model scenario flows and their respective peaking factors are as follows:
 1. Maximum day: Defined as 2 times the average day total use flow as determined per Figure 6-1.2 (use gpm value).
 2. Peak hour: Defined as 3.5 times the average day total use as determined per Figure 6-1.2 (use gpm value).
 3. Note: These peaking factors shall be appropriately increased for restaurants and high-demand water users, or as designated by the Water Resources Department after review.
- C. The maximum allowable pipe head loss for the various water pipelines is as follows:
 1. Transmission mains: 8 feet per 1,000 feet (3.5 psi per 1,000 feet)
 2. Distribution lines: 10 feet per 1,000 feet (4.3 psi per 1,000 feet)
 3. Service lines – domestic, dedicated fire, or combined domestic/fire: size as required to satisfy both hydraulic modeling requirements and Fire Code. Generally, velocities of more than 5 feet per second are undesirable. Velocities more than 7.5 feet per second are not allowed.
 4. As otherwise designated by the Water Resources Department

SYSTEM FLOW TEST REQUIREMENTS & USE OF RESULTS

6-1.405

Pressure and available flow information for existing water lines must be obtained by having a fire hydrant flow test performed on the system. Hydrant flow tests are required for the following situations:

- A. On all commercial projects, multi-family residential projects, and public extensions of the city's water distribution system.
- B. For any proposed system connecting to the existing distribution system, the design capacity of the existing system (flow versus pressure) will need to be determined by the engineer.
- C. Prior to acceptance by the city, all platted subdivisions shall conduct an additional flow test at the lowest and highest elevation available in which the development is constructed.
- D. Developments that cross pressure zone boundaries must conduct a flow test within each pressure zone.

A private fire protection company shall perform the tests and certify the results. A right-of-way permit issued by the One Stop Shop is required for a flow test and the Inspection Services Division will be notified a minimum of 48 hours before performing the flow test. The permit is also available [online](#). Refer to the [flow test design form](#).

The certified tests must be included in design reports or submitted along with the final plans to Plan Review should a design report not be necessary.

The acceptable hydrant flow testing procedures and requirements are detailed below.

A. Specific Hydrant Flow Test Procedures and Requirements

1. Flow tests will be conducted during periods of high water use, such as 6:00 am to 8:00 am, or as directed by the Water Resources Department.
2. Flow tests shall be coordinated with and witnessed by the appropriate city staff. Scottsdale staff that coordinated and witnessed the flow test shall be provided with the results.
3. Selecting the location of the flow and residual pressure hydrants:
 - a. The flow hydrant shall be on the existing main distribution system line where the connection point is currently located, or proposed, and as close as possible to the new proposed connection or existing tee.
 - b. The residual hydrant shall be located on the same existing distribution supply line as the flow hydrant and as close as possible to the flow hydrant.
 - c. If the existing supply line is a dead-end line on one end with relatively small demand strong preference should be given to selecting a residual hydrant upstream of the flow hydrant on the dead-end portion.
 - d. Avoid selecting a residual hydrant that will result in additional existing distribution lines tying into the existing main supply line between the flow and residual hydrants.
4. Required flow test map:
 - a. Provide a map with a distance scale showing the local existing water distribution network with all relevant pipe diameters, street name labels, flow and residual hydrant locations, and location of future tap(s) or subject property.
 - b. Show pipeline distances and diameters between the residual hydrant and the flow hydrant
 - c. Show ground elevations for the following:
 - iii. Residual and flow hydrants
 - iv. Future tap(s) or subject property
 - d. Show flow directions in the system during hydrant test, if known.
5. Required flow and pressure data points:
 - a. Hydrant static pressures @ zero hydrant flow (measure static pressures at both the residual and flow hydrant. Both measurement shall be taken within 15 minutes of each other)
 - b. Residual pressure @ intermediate hydrant flow (hydrant valve partially open). Provide flow determination and residual pressure.
 - c. Residual pressure @ full open hydrant flow. Provide flow determination and residual pressure.
 - d. Note: Allow hydrant flow to stabilize before taking measurements
6. Other data to supply:
 - a. Test date and time
 - b. Certification name, level, number, and seal
 - c. Calculations:

- i. Measured flow calculation equation and supporting information such as orifice diameter, discharge coefficient, and pitot tube readings
 - ii. Projected flow calculation at max static pressure of 72psi and 20 psi residual system pressure. Show all calculations.
 - iii. Note to engineer: Unless the flow and residual hydrant meet the criteria in the section below, the direct and projected unadjusted hydrant flow test results should only be used as a general guide or the system capacity. For modeling purposes adjustments to the test data may be required as described in the next section.
- B. Guidelines to Adjust the Flow Test Results for Use in Required Hydraulic Modeling**

This section serves as a guide to instruct the engineer on how to develop a supply curve or hydraulic grade line from the flow test results that can be used for hydraulic modeling scenarios. Refer to Section 6-1.202 for more information on modeling requirements.

1. Step 1: Adjusting Flow Results

Reduce all measured test flows by 10% to account for flow measurement inaccuracy and non-ideal flow hydrant location (1.10 safety factor).

2. Step 2: Adjusting Pressure Results-Flow Hydrant versus Residual Hydrant Location:

In a basic hydrant flow test the flow at the flow hydrant is correlated to the pressure at the residual hydrant. However, the goal is to know both the flow and corresponding pressure at the flow hydrant (i.e., the connection point to the existing system). Only when the pressure in the supply line at the residual hydrant is effectively equal to the pressure in the supply line at the flow hydrant, can the flow test pressure results be used without this specific adjustment to model the system's hydraulic capacity (i.e., to develop a system supply curve).

The pressure in the main line at the tee to the residual hydrant is effectively equal to the pressure at the tee to the flow hydrant when both the following are true:

- a. The residual and flow hydrant are at the same elevation, and;
- b. The head loss between the residual and flow hydrants during the flow test is determined to be negligible (less than 3 psi). This head loss determination adopts the simplifying assumption that 100% of the flow test flow passes through the mainline tee/tap of the residual hydrant (if physically possible).

If either of the above items are not true, the engineer must adjust the resultant residual hydrant test pressures as follows:

- a. Adjusting for hydrant elevation pressure:
- b. If the difference in ground elevations of the flow and residual hydrant is greater than 7 feet, add or subtract the equivalent pressure from all the measured residual pressures (including static). Combine with adjustment in the following two steps if applicable.
- c. Adjusting for dynamic head loss pressure.

- d. In cases where it cannot be clearly shown otherwise, assume that 100% of each of the two test flows is flowing from the supply main, through the tap or tee of the residual hydrant, and on to the flow hydrant*. Calculate the dynamic head loss in the main between the residual hydrant tee and the flow hydrant tee for each test flow. Subtract each calculated head loss from each of the two corresponding measured residual pressure points. Do not adjust the static pressure point. Combine with adjustment in step 1 and 3 if applicable.

*Note: This is considered a worst-case scenario and avoids the complexity of determining flow directions and magnitude in the existing pipe network.

3. Step 3: Adjusting for static HGL pressure differences
4. After accounting for the hydrant elevation difference if the difference in the pre-test static pressures measured at both the residual hydrant and flow hydrant is greater than 3 psi then this value must be subtracted from all the measured residual pressures (including static). Combine with adjustment in step 1 and 2 if applicable.
5. Step 4: Adjusting for system supply pressure variations
 - a. When the resultant static pressure exceeds 80 psi (after applying adjustment steps 1 through 3) the maximum design static pressure to be used shall be 72 psi regardless of actual static test pressure. The slope of the previously adjusted water supply curve shall be used even though the design static pressure is reduced to 72 psi. Applying adjustments steps 1 through 4 will result in the final design supply curve to be used for hydraulic modeling.
 - b. When the resultant static pressure is less than 80 psi (after applying adjustment steps 1 through 3), a minimum 10% safety factor shall be subtracted from the measured static pressure to obtain the resultant static pressure. The slope of the previously adjusted water supply curve shall be used even though the design static pressure is reduced. Applying adjustments steps 1 through 4 will result in the final design supply curve to be used for hydraulic modeling.

Note: If the final design supply curve developed in this step is not sufficient to supply the development with adequate pressure and flow as described herein the Water Resources Department may require that a second flow test be performed to evaluate if exceptions to any of the flow test adjustment criteria can be made. Any exceptions are at the sole discretion of the Water Resources Department.

PRESSURE REQUIREMENTS

Pressure extremes in water systems result in the potential for contaminants to enter the network. Low pressures in the water system may allow polluted fluids to be forced into the system, and high pressures may cause ruptures or breaks in the network. The system requirements are as follows:

- A. The static pressure in the distribution system shall not exceed 120 pounds per square inch (psi).

6-1.406

- B. The system shall be designed to maintain a minimum residual pressure of 50 psi at the highest finished floor level to be served by system pressure under normal daily operating conditions. Refer to Section 6-1.202 for additional info an.
- C. The system shall be designed to maintain 30 psi minimum pressure at the hydrant tee/tap under design fire flow requirements. Refer to Section 6-1.501. A domestic service pressure of 15 psi must also be simultaneously maintained at the highest finished floor. Note that the 30-psi minimum pressure design requirement provides a 10-psi safety factor to account for aging infrastructure and flexibility in locating pressure zone boundaries. Refer to Section 6-1.202 for additional info.
- D. All distribution water mains, appurtenances and service lines will be designed for a minimum normal internal working pressure of 150 psi plus allowance for water hammer. Note: Working pressures for transmission lines must be verified with the Water Resources Department.
- E. Refer to Section 6-1.202 for the specific required hydraulic modeling scenarios and criteria.

Water hammer may produce momentary pressures greatly more than normal static pressures, thus increasing the probability of water main failure. Suitable provisions must be made to protect the system from water hammer pressures. The occurrence and severity of water hammer can be reduced by using slow-closing valves, pressure-release valves, surge tanks, variable frequency drives, soft start motor controllers and air chambers. In cases where pressures exceed 120 psi or water hammer conditions are developed, all elements of the system will be designed accordingly.

PRESSURE-REDUCING & REGULATING VALVES

6-1.407

Approximate pressure zone boundaries and their respective elevations are shown in Figure 6-1.3. PRVs will be required when necessary to maintain pressure zones within the distribution system. Distribution systems will not be designed to operate at pressures more than 120 psi. PRVs shall be designed in accordance with COS Standard Detail No. 2341-1 and 2342-2 and the city's Design Standards Development for PRVs and Air Relief Valves (AVs), which are available online.

A minimum of one PRV in each pressure zone will be designed with a high-pressure relief valve.

PRV vaults shall be located outside of paved areas generally adjacent to the back of curb or sidewalk. Vaults must be within the right-of-way or an easement and will be provided with unobstructed vehicular access. Curbs adjacent to vaults will be roll or mountable type. Site grading will route storm water and discharge water from relief valves away from the vault. Site design will consider the impacts of discharge water on downstream improvements. The location of pressure relief risers shall be shown on the final plans. The engineer shall specify on final plans, the size of the main line valve and bypass valve, the upstream system pressure, and the design downstream pressure setting. Where multiple PRVs supply a pressure zone, the engineer may request the Water Resources Department to consider eliminating the bypass valve where redundancy occurs.

The city operates its system from wells and pumps that commonly have pressures exceeding 80 psi. Changes in demand, supply and the operation of the distribution system also vary the pressure within the system. Therefore, the city requires all

metered services to have a pressure-regulating valve installed on the private service line. Existing structures that are required to obtain a plumbing permit for home improvements are required to install a pressure-regulating valve if one is not present. A written variance request may be submitted to the Water Resources Department for their review and concurrence or denial.

FITTINGS

No water line will be deflected either vertically or horizontally, more than that recommended by the manufacturer of the pipe or coupling or as stated in Section 6-1.402, without the appropriate use of bends or offsets. Fittings may be required where more than 2 pipe lengths are deflected.

The engineer is responsible for verifying the minimum distance necessary between taps and fittings for the type and diameter of pipe.

Tapping sleeves shall not be used where the branch diameter is equivalent to the mainline diameter.

Fittings installed into asbestos cement pipe (ACP) or PVC pipe within 6-feet of another fitting or joint will require that section of pipe to be removed and replaced with DIP.

Existing tees, tapping sleeves and related appurtenances that are not utilized by a development shall be removed by the contractor. A minimum 3-foot section of pipe shall be removed, with no less than 6 feet remaining to the nearest joint. The removed pipe shall be replaced with DIP.

SHUTOFF VALVES

Shutoff valves will be located such that closing no more than 4 valves can isolate any section of the system. Valves shall be installed on water mains at locations that allow sections of the system to be taken out of service for repairs or maintenance without significantly disrupting service in other areas. Consideration should be given to the number of fire hydrants taken out of service.

Maximum spacing of water distribution main isolation valves:

- A. In commercial, multi-family, and industrial areas, valve spacing will not exceed 500-foot intervals.
- B. In single-family residential (R1-) and other areas, valve spacing cannot exceed 800-foot intervals, or 1 per block, whichever is less.

Maximum spacing of water transmission main isolation valves:

- A. At every mile section line, install a cross with a valve on each leg of the cross.
- B. Valves spacing between mile section lines will not exceed 1,320 feet unless otherwise allowed by the Water Resources Department.

Any design not complying with the above spacing requirements must be approved in writing by the Water Resources Department.

Tees shall have a valve on the lateral line, so the lateral can be taken out of service without interrupting the supply to other locations. At intersections of distribution mains, the required number of valves will normally be one less than the number of radiating mains. The non-valved branch should be the line that supplies flow to the intersection.

6-1.408

6-1.409

Install shutoff valves for new construction at the point of curvature (PC) of curb returns at street intersections and aligned with a property line or a lot line at mid-block locations.

Provide valves to allow for isolation of lines crossing washes with a capacity exceeding 500 cfs, major and minor arterial roads, bridges, and locations where lines have been vertically deflected to cross other infrastructure.

Valves shall not be installed in sidewalks, curbs, crosswalks, multi-use paths, driveways or bicycle lanes.

Valves 12 inches or smaller are to be resilient wedge type. Valves 16 inches or larger shall be low torque resilient wedge or butterfly type. All valves 16 inches or larger shall have bypasses per COS Standard Detail No. 2361* unless otherwise approved by the Water Resources Department. The valve operators on butterfly valves 16 inches or larger in diameter shall be installed entirely with a manhole for repair or replacement. Configure entrances to manholes so that the internal valve parts can be serviced. Manholes on water appurtenances shall be the hinged type frame and cover in accordance with COS MAG Supplement, Section 610.8.

Pressure rating on all valves will be equal to or greater than the pressure rating of adjacent pipe.

All valves require valve boxes installed per MAG Standard Detail No. 391-1, Type "C", with locking lids.

All valve frame and cover adjustments will be per COS Standard Detail No. 2270.

AIR RELEASE VALVES

6-1.410

- A. Air release valves will be installed at all changes in slope of water lines 8 inches or larger in diameter, as follows:
1. When water line changes from a positive slope to a zero slope, or a negative slope in the primary direction of flow;
 2. When water line changes from a zero slope to a negative slope in a primary direction of flow;
 3. For vertical alignment changes to cross under or over another facility, such as utility, drainage washes, etc. Refer to COS Standard Detail No. 2370, and Sec. 6-1.415.
 4. Air release valves may be omitted if service taps or fire hydrant laterals are located to allow for the elimination of air.
 5. Slopes less than or equal to 0.002 ft. /ft. shall be treated as zero slopes. In the absence of any changes in slope, air release valves will be installed not more than 2,640 feet apart.
 6. All air release valves will be a combination air/vacuum release type per COS Standard Detail No. 2348.
- B. Air release valves will be installed on 6-inch water lines under the following circumstances:
1. At the high point of the line if no lateral, fire hydrant, or water service connection is proposed at that location to adequately remove trapped air.
 2. Refer to COS Standard Detail No. 2370, and Section 6-1.415 for vertical separation and vertical alignment for crossing under or over another facility, such as utility, drainage washes, etc.

- C. Air release valves on lines 12 inches and smaller can be in a manhole over the water line. Air release valves on lines 16 inches and larger will be in an above-grade enclosure adjacent to the roadway where applicable. Locations for all valves and vent pipes must be shown on the final plans and will be within the rights-of-way, private street tract, or easement.

THRUST RESTRAINT

6-1.411

Pipeline thrust occurs at horizontal and vertical bends and lateral branches. Thrust blocks will not be allowed for new construction on the city's water system unless approved in writing by the Water Resources Department. Thrust restraint shall be provided by:

- A. Welded joints in steel pipelines.
 - B. Mechanical joints in concrete and DIP.
 - C. Locking gasket and ring systems acceptable to the Water Resources Department.
- The determination of whether a given section of pipeline needs restrained joints, or other means of anchorage, shall be made by the engineer and reviewed by Plan Review.

Design all thrust restraint for 1-1/2 times the static line pressure or 200 psi, whichever is greater. MAG Standard Detail No. 303-1 and 303-2 are acceptable means of joint restraint. The engineer shall consider the water pressures and soil bearing pressures assumed by the standard details. Where joint restraint is not proposed per MAG Standard Detail No. 303-1 and 303-2, the engineer will submit joint restraint calculations with the final plans for review and comment.

All restrained pipe lengths must be specified on the final plans or referenced to a standard detail.

ELECTRONIC MARKERS

6-1.412

Final plans shall call out electronic markers to indicate all horizontal changes in direction. Valve locations permit adequate identification of pipeline location (typically at crosses and tees) and do not require electronic markers. An electronic marker must be placed at the center of all fittings at a depth of 2 to 4 feet below finish grade per COS Standard Detail No. 2397.

Long, straight reaches of transmission mains will be marked every 1,320 feet with an electronic marker.

PIPE COVER

6-1.413

Cover or depth of bury for water mains will be measured from the proposed finished grade as follows:

- A. For lines smaller than 12 inches in diameter, allow a minimum cover of 36 inches to the top of pipe unless otherwise approved by the Water Resources Department.
- B. For lines 12 inches in diameter, allow a minimum cover of 48 inches over the top of pipe.
- C. For lines larger than 12 inches in diameter, allow a minimum cover of 60 inches over the top of pipe.

- D. For all lines within industrial zoned areas or under major roadways (collector, arterial, couplet, or parkway/expressway), allow a minimum of 60 inches over the top of the pipe.

If a water line is installed within an area to be filled later, adequate pipe protection must be provided. This may include temporary berms or constructing the water line to a minimum cover below the existing grade. Concrete encasement of new water lines is prohibited unless approved by the Water Resources Department.

Caution should be taken in design and construction to protect all water supplies from wastewater contamination.

When more than 3 feet of existing PVC or ACP water lines are exposed during construction and the bedding is disturbed, the water line must be replaced with DIP (minimum Class 350) with mechanical joints or flanged joints to 3 feet past the sides of the exposed crossing trench. Refer to MAG Standard Detail No. 403-3.

Hydrants that require adjustment as a result of improvements will be adjusted using a "GradeLok" or approved equal when vertical adjustment is more than 6 inches.

Hydrants must have depth of burial of 3.5 feet per COS MAG Supplement, Sec. 610.8.

WASH CROSSING

6-1.414

All wash crossings will be constructed using restrained joint DIP. Depth of bury requirements to place water lines under washes or channels shall be based upon the 100-year peak discharge in channel or wash (Q_{100}). The additional depth of bury is in addition to the normal cover requirements described in Section 6-1.413.

100 YEAR FLOW RATE	ADDITIONAL DEPTH OF BURY
1 to 49 cfs	1 foot
50 to 99 cfs	2 feet
100 to 499 cfs	3 feet
more than 499 cfs	Scour depth based on scour analysis

Scour depth will be estimated using Arizona State Standard Attachment (SSA) 5-96, Guideline 2, Level I, as published by the ADWR. The engineer will estimate the depth of scour and design the top of pipe to conform to Section 6-1.413. The engineer shall submit the scour analysis with the final plans.

All pipelines located within the scour zone, or with less than the minimum required depth of bury as indicated above, must be protected by installing a cut-off wall per COS Standard Detail No. 2228 downstream of the pipeline to stabilize the scour depth. Plan Review will review protection requirements under these instances on a case-by-case basis. Cut-off walls will be structurally designed to the scour conditions calculated.

VERTICAL SEPARATIONS AND REALIGNMENTS

6-1.415

- A. Vertical separation of water and sanitary sewer (SS) lines must follow COS Standard Detail No. 2401. Where conditions prevent adequate horizontal and vertical separation:

1. both the proposed water and sewer lines shall be constructed of DIP (minimum Class 350) or,
 2. where the existing water line is other than restrained ductile iron, the water line shall be replaced with restrained DIP per MAG Standard Detail No. 404-2, and/or,
 3. where the existing sewer line is other than restrained ductile iron, the sewer line shall be encased in concrete per MAG Standard Detail No. 404-3 or replaced between manholes with DIP (minimum Class 350) with a cured-in-place liner.
- B. Separation of water from electrical or gas lines will conform to COS Standard Detail No. 2372.
- C. Water lines crossing over culverts and SDs must maintain both a minimum of 12 inches vertical separation and the minimum depth of bury. If the design cannot provide these clearances, a vertical realignment is necessary.
- D. For minimum clearance under culverts, SDs, and other utilities, refer to COS Standard Detail No. 2370 and 2372. The vertical realignment shall be constructed of DIP and shall not be deflected or swept. Air release valves and isolation valves shall be installed as per the following:
1. Install isolation valves on each side of the vertical realignment to minimize disruption of service should the crossing need to be isolated for maintenance or repair. Plan Review may consider the location of adjacent valves, fire hydrants, and water service lines to help minimize valves at vertical realignments.
 2. For dead-end water lines, place the required air release and isolation valves on both sides of the vertical realignment.
 3. For looped applications, install air release valves at a location calculated by the engineer to release any air trapped in the system.
 4. Do not place tees, fire hydrants, service lines, and other appurtenances within any portion of the vertical realignment unless approved in writing by the Water Resources Department.
 5. Vertical realignments on existing waterlines shall minimize disruption to the distribution system. Prior to connecting with the existing main, vertical realignments over 25 feet in length will be constructed to a minimum 3 feet offset from the existing line and tested per MAG Sec. 610 COS Supplement Sec. 610. Use separate horizontal or vertical bends to change pipe alignment. Do not rotate fittings to accomplish combined vertical and horizontal deflections.

SERVICE LINES AND METERS

Buildings with mixed uses should consider a separate meter and be separately plumbed for each type of use. Scottsdale's sewer billing structure supports separate metering for each of the user codes described in SRC Sec. 49-141(g). In the event separate use metering is not provided, sewer billing will be applied at the higher use rate applicable to that building. Developers should consider the economic benefits of separate metering.

For planning and city design review purposes service lines and meters shall be sized per the analysis process described in Section 6-1.202, Model Scenario 4, Service Line

6-1.416

Design Flow. Ultimately, final meter size will be determined during the building plan review process where a final determination of water fixtures, landscape irrigation, and fire sprinkler requirements can be made. Primarily this involves a water fixture analysis and demand determination with some adjustments and, in the case of single family residential properties, subsequent comparison of the resultant modified fixture flow to the required fire sprinkler flow required by Fire Code. Once the appropriate maximum service line flow is determined Fig. 6-1.4 shall be used to determine the appropriate meter size to be used. When evaluating fixture unit demand, as determined by the applicable Plumbing Code, the final Service Line Design Flow used to size the meter shall not exceed the flow shown in Fig. 6-1.4 including a 1.5 safety factor on the determined flow.

Note: Where the developer or engineer can make a case that a modified fixture unit demand determination (or applicable Fire Code sprinkler flow determination) is not possible or reasonable to conduct as described per Section 6-1.202 Model Scenario 4, the developer or engineer can request that the Water Resources Department make a determination based on the average day demand values (in gpm) combined with a reasonable peaking factor applicable to the development being served. The peaking factor used in this case will be much higher than either max day or peak hour as previously defined in this DS&PM chapter for system modeling purposes. Flow determinations for a specific service line and meter sizing must reflect realistic maximum conditions to ensure adequate pressures and meter accuracy.

- A. That portion of the water service from the water main up to, and including the meter is public and will be maintained by the city. That portion of the water service from the meter into the site is private and will be maintained by the property owner. Design of the private on-site portion of the water service will comply with the current Plumbing Code and shall include a pressure-regulating valve.
- B. Water service lines shall be 1-inch minimum Type "K" copper tubing unless prior approval is obtained from the Water Resources Department.
- C. Due to the city's water billing rate structure, meter sizes shall not exceed the size of the service line (a 1-1/2-inch meter will not be allowed on 1-inch service). Extra attention is recommended when sizing services for custom home lots where demands occasionally necessitate meter sizes exceeding 1 inch.
- D. Residential service lines are necessary to meet domestic, fire, and irrigation demands. Residential fire sprinkler and irrigation demands are usually supplied through the domestic service line and meter. A 1-inch water service line that will exceed fifty feet in length (between the main and the meter) should be increased to a larger diameter service pipe to offset pressure losses to the fire sprinkler system. Commercial developments typically will use separate meters for building and landscape service and provide separate lines for fire protection.
- E. Each service line requires a separate tap to the public main. Connection of 2 or more meters in a manifold configuration is prohibited.
- F. Installation of metered 1-inch to 2-inch water services will be in accordance with COS Standard Detail No. 2330. Installation of 3 inch to 6-inch metered services require a tee and shutoff valve or tapping sleeve and valve on the public main per

MAG Standard Detail No. 340 and 391-1, Type "C", and a meter vault in accordance with COS Standard Detail No. 2345.

- G. Final plans will show locations of service lines and meters to each unit referenced with stations and dimensions, or offsets, from the street centerline or monument line. Service lines and meter boxes will be located within a public rights-of-way easement within a private street tract, or a utility easement. Meters are to be accessible to city workers and be located as close as possible to the water main.
- H. Plans shall accurately show meter vaults to scale, clearly showing access covers and vaults for meters 3 inches and larger. Meters shall be located cross back through the right-of-way or easement with a service line. Water service lines and meters shall not be in driveways, sidewalks, washes, or detention basins.
- I. Water service lines on lots smaller than 1/2 acre will be located within 3 feet of the property line adjacent to the adjoining parcel's water service line. Water service on lots 1/2 acre and larger will be located within the lower 1/3 of the property frontage to the water main, avoiding Natural Area Open Space (NAOS) and adjacent to the sewer service where practical.
- J. Water services will be designed perpendicular to the main where possible. Lines shall be continuous from the main to the meter with no bends or joints. Water service lines will have 6-foot minimum horizontal separation from SS service lines.
- K. No service or fire line connections will be made directly to water lines 14 inches or larger in diameter or to water lines designed solely to transmit water from one pressure zone to another.
- L. All galvanized iron and polyethylene water service lines in sizes 3/4 inch through 2 inches, which are exposed during construction, will be replaced in their entirety with Type "K" copper tubing. Copper service lines smaller than 1 inch exposed during construction shall be replaced in their entirety with 1-inch Type "K" copper tubing. This includes the replacement of iron service saddles with bronze saddles and replacement of both the corporation stop and meter stop.
- M. Existing water and fire lines not used by a development shall be noted on the plans to be abandoned at the main by the contractor per Section 6-1.402.

DISC METER SIZE (INCHES)	INITIAL SERVICE LINE DESIGN FLOW ^{(1) (2)} (GAL. /MIN.)
5/8	20
3/4	30
1	50
1 1/2	100
2	160
COMPOUND METER SIZE (INCHES)	INITIAL SERVICE LINE DESIGN FLOW ^{(1) (2)} (GAL. /MIN.)
3	350
4	600

6	1,350
TURBINE METER SIZE (INCHES)	INITIAL SERVICE LINE DESIGN FLOW ^{(1) (3)} (GAL. /MIN.)
3	550 ⁽³⁾
4	1,000 ⁽³⁾
6	2,000 ⁽³⁾

Figure 6-1.4 Notes:

1. The listed meter sizes shall be compared to the Initial Service Line Design Flow as described in Section 6-1.202, which applies a 1.5 flow safety factor. Subsequent stages of a development review shall incorporate all potential meter water demands and apply a 1.5 safety factor to the resultant flow rate to determine the correct meter size per this table. The 1.5 safety factor can be excluded only during final meter sizing for single family and individual townhome meters.
2. The Initial Service Line Design Flow is based on the AWWA Manual of Water Supply Practices M22, 3rd Edition (2014), Table 6-1, Maximum Flow Rates. These values ensure that the design flow, excluding the 1.5 safety factor, shall fall within an acceptable range of the AWWA M22 high normal flow rate. The Water Resources Department defines 50% to 150% of the AWWA high normal flow rate as the generally accepted range for the meters associated with this note.
3. The noted values represent an increase of the maximum flow rates listed in the AWWA Manual of Water Supply Practices M22 3rd Edition (2014). These values ensure that the design flow, excluding the 1.5 safety factor, shall fall within an acceptable range of the AWWA M22 high normal flow rate. The Water Resources Department defines 50% to 105% of the AWWA high normal flow rate as the generally accepted range for the meters associated with this note.

FIGURE 6-1.4 DESIGN METER CAPACITIES

BACKFLOW PREVENTION & CROSS CONNECTION CONTROL

6-1.417

All metered services within the city, other than single family residential, require the installation of an approved backflow prevention device immediately adjacent to the meter on private property unless approved otherwise by the Water Resources Department. To determine the type of backflow protection required for a specific use, refer to SRC, Chapter 49, Division 3 Backflow Prevention and Cross Connection Control. The back-flow prevention valve and the meter will be of equal size, unless the engineer submits calculations with final plans demonstrating that losses through a smaller device do not adversely affect water pressure to the building. For installation requirements refer to the current version of the COS Standard Detail No. 2351 through 2356. Backflow prevention devices are to be owned and maintained by the property owner.

- A. All backflow prevention devices shall be shown to scale and stationed on the plans. The location of backflow preventers and the adjacent meter shall take into consideration opportunities to screen with landscaping or consolidate into

common areas providing utility service to a building. Generally, backflow preventers shall not be located at:

1. Entrances to buildings unless appropriately screened.
 2. At locations where they interfere with opening car doors.
 3. Areas of high visibility
- B. Every effort must be made to locate the water meter and vault in an area that can accommodate a properly installed backflow assembly.
- C. When the location of a backflow preventer cannot be accommodated adjacent to the meter, the designer shall:
1. Request permission from the Water Resources Department to separate the meter from the backflow preventer.
 2. Backfill the water line between the meter box and the backflow preventer with 1-sack controlled low strength material (CLSM) per MAG, Section 728. CLSM shall be placed to the full width of the trench and to 6 inches above top of pipe.

Note on the plans that inspection of the water piping connecting the meter to the backflow preventer be inspected by a city backflow prevention specialist prior to CLSM and backfill.

Fire lines require backflow prevention at either the vertical riser, or at the property line when permitted. Refer to Section 6-1.504, for additional information.

The city requires backflow prevention on temporary construction meters for all extensions of the water system per COS Standard Detail No. 2346. For additional information, contact the Water Resources Department for a backflow prevention specialist.

SAMPLING STATIONS

6-1.418

Water sampling stations are generally required in all new residential subdivisions consisting of twenty or more platted lots. Developers shall contact the Water Quality Division prior to the preliminary plat submittal for a determination. Sampling stations are to be located within the right-of-way, a private street tract, or utility easement at mid-street, 3 feet behind the sidewalk, along a property line extension.

Construction will be per COS Standard Detail No. 2349. Large developments constructed in phases will be required to install the sampling station on the first phase and each subsequent phase when the overall number of dwelling exceeds 300.

Manufacturer of these sampling stations shall be "Koraleen," or approved equal, with a stainless-steel ball valve.

TRACT AND EASEMENT REQUIREMENTS

6-1.419

Water lines outside of a public right-of-way or a private street tract must be placed in a minimum 20-foot-wide easement located within a dedicated tract unless approved otherwise by the Water Resources Department. The easement may be a portion of a utility tract, drainage tract or open space tract.

Easements for transmission lines or water lines with cover more than the minimum requirements may require easements wider than 20 feet. These easement widths will be determined by the Water Resources Department to meet access and maintenance

needs. Horizontally, a minimum of 6 feet is required between the water line and the edge of the easement.

The tract/easement shall be accessible from a public right-of-way. The easement will be free of obstructions, shall not be in a fenced area, and shall be accessible always to city service equipment such as trucks and backhoes. Areas in question shall be approved in writing by the Water Resources Department. Water Resources may approve gates or removable type fencing across the easement. In addition, Plan Review will evaluate, on a case-by-case basis, situations where encroachment into the easement with structural improvements such as screen walls and paving cannot be avoided.

- A. No water line will be installed in an easement outside of a tract unless the Water Resources Department has approved in writing the placement of the line in an easement and the property owner has granted the necessary easement to the city.
- B. Water line easements outside of paved areas shall have a 10-foot-wide hardened path with a cross-sectional slope not greater than 10% and a longitudinal slope not greater than 20%. Hardened paths shall consist of native soil compacted to 95% to a depth of 1 foot from the existing or design surface, whichever is lower. Revegetation within the easement shall consist of low growing shrubs or plant material acceptable to the Water Resources Department. Trees may be located along the edge of the easement but not within 7 feet of the water line as measured to the trunk of the tree. Attention shall be given to the aggressive nature of vegetation roots to prevent plants that may be harmful to water lines.
- C. If access across a desert wash is not practical, the Water Resources Department may approve turn around areas at each side of the wash. Hammerhead turnaround configurations are acceptable allowing for turning movements of a full size pickup truck.
- D. A copy of any written approval from the Water Resources Department shall be submitted with the final plans.

EASEMENT RELEASE/ABANDONMENT REQUIREMENTS

6-1.420

When a property owner or developer believes a water line easement, or portion thereof, is no longer required by the city, abandonment may be requested by completing and filing an [application](#) through the city's One Stop Shop.

After completing and filing the application, the property owner or developer shall send a letter or email requesting release of the easement to the Water Resources Department with the following exhibits attached:

- A. A detailed map highlighting the easement to be abandoned and locations of any existing water lines shown about the easement.
- B. If existing water lines are to be abandoned, a detailed civil plan prepared by a professional engineer licensed in the State of Arizona must be supplied describing the method of abandonment and any necessary relocation of the water lines.

The Water Resources Department will issue a determination recommending approval or denial of the request along with any stipulations that may be required in conjunction with the abandonment.

The determination shall be attached to an Application for Release of Easement and must be submitted by the applicant to the One Stop Shop for subsequent processing

by the city. Failure to comply with the above process will result in a denial of the request. Where replacement rights are requested by the city, the city will not relinquish existing rights until the replacement rights have been granted.

FIRE PROTECTION

6-1.500

It is the intent of the COS Fire Department to establish requirements consistent with nationally recognized practices for safeguarding life and property from hazards of fire and explosion arising from the storage, handling and use of hazardous substances, materials and devices, and from conditions hazardous to life and property arising from the use or occupancy of buildings or premises.

For complete Fire Department related issues, refer to Chapter 11.

A. Ordinance Requirements

For information related to the current adopted plumbing and fire codes refer to the [SRC](#). For Fire Code Adoptions refer to Chapter 36, and Chapter 31 for Building and other related code adoptions.

B. Design Policy

If the property is to be supplied with domestic service and with fire flows from a storage tank or facility, the engineer must provide a report indicating that sufficient volumes exist, as required by the Fire Department, and are available to meet the calculated fire demands as defined by the engineer.

Attention will be given to the fire hydrant locations on final plans for infrastructure where future building locations are not identified. Final building location and floor may necessitate the addition of another water line, fire hydrant, and/or fire pump to serve that structure after the city has accepted the system. Compliance with the fire hydrant spacing and pressure requirements are the responsibility of the party requesting a building permit, as these requirements are a condition of that property's development.

FIRE FLOW REQUIREMENTS

6-1.501

Water distribution facilities shall be sized and required to supply the consumption needs of the potable water system along with the ability to deliver a minimum fire flow of:

- A. A minimum of 500 gpm to one and two family residential properties with interior fire sprinkler systems.
- B. A minimum of 1,000 gpm for R1- properties located in the county.
- C. A minimum of 1,500 gpm for commercial, industrial and multi-family residential properties.
- D. Larger structures (over 6,000 gpm and non-sprinklered per Appendix B of the International Fire Code (IFC)) may require fire flow above 1,500 gpm depending on construction type. Verify fire flow requirements with the Fire Department.
- E. A minimum of 2,500 gpm for high rise structures to account for potential fire-fighting activities.

Refer to the latest city adopted version of the IFC, Appendix B, to verify if the fire flow requirements exceed the minimum requirements stated above. The minimum 1,500 and 500 gpm fire flow requirements are stated in SRC, Section 36 - 41 for fully

sprinkled developments. The minimum 1,000 gpm fire flow requirement is stated in the IFC and does not assume a fully sprinkled development.

HYDRANT LOCATIONS

6-1.502

The spacing of fire hydrants is to be measured along the street or roadway in which a fire hose would be laid. Generally, this spacing is measured along the curb line and shall be inclusive of the distance along a private driveway to the proposed structure. The Fire Department will stipulate fire hydrant locations during the site planning process or on the final plans review. The following standards shall be used as a guide:

- A. The spacing of the fire hydrants in developments consisting of lots with detached single-family residences on each lot must be no more than 1,200 feet on center when street grade is less than 9%, and no greater than 600 feet on center when street grade is greater than 9%. When a cul-de-sac is greater than 600 feet in length, an additional fire hydrant must be installed. A residential structure must be located within 600 feet of a fire hydrant as measured along the streets and driveways. Additional hydrants and attention to the spacing may be required to meet the distances above for large lots including, but not limited to, those areas zoned R1-18 (18,000 square feet) or greater.
- B. The spacing of fire hydrants in commercial and industrial areas and in attached multi-family residential developments, such as apartments and condos, must be no greater than 700 feet. This spacing applies to interior, on-site fire lane locations for hydrants, as well as to locations along public rights-of-way or private street tracts. A structure in this category must be located within 600 feet of a fire hydrant as measured along the accessible fire routes.
- C. The spacing of the fire hydrants in the county must be no more than 660 feet. No structures shall be located more than 330 feet from a fire hydrant, as measured along the rights-of-way, private street tract or utility easement.
- D. A 6-inch fire hydrant lateral shall not be tapped for firesprinkler supply lines.
- E. Auxiliary fire hydrant valves must be connected to the main water line by a flanged tee.

For more information contact Fire Department Plan Review at 480-312-2500 or visit [COS Fire & Life Safety](#).

PAVEMENT MARKERS

6-1.503

Two-way, reflective blue, raised pavement markers must be provided to identify the location of fire hydrants and remote fire department connections in accordance with COS Standard Detail No. 2363*. These markers are readily available from businesses providing highway marker materials.

FIRE AND BUILDING SPRINKLER LINES

6-1.504

- A. Determine the location of on-site fire lines and taps by the site relationship of the fire department connection, riser location, emergency access and fire hydrant locations.
- B. Determine the size of fire lines from the flow test data and subsequent hydraulic analysis provided by the engineer for design of the project. Fire systems must include a city approved backflow prevention device. An approved, vertically

mounted backflow prevention device (double check valve) located on the building riser is preferred by the Fire Department.

- C. Show all fire lines on the civil site final plans.
- D. Fire lines shall not be connected to 14 inches or larger transmission lines.
- E. Installation of 1½ to 2-inch fire service lines use a saddle connection per COS Standard Detail No. 2362-1, and installation of 3 inch and larger fire service lines use a tee and valve per COS Standard Detail No. 2362-2. Meters are not required on services used solely for fire sprinkler systems.
- F. Fire service lines shall be installed perpendicular or radial to the main line within the right-of-way or easement.
- G. All on-site fire line construction shall comply with the MAG Standard Specifications and Details and the COS Supplements thereto.

BUILDING SPRINKLER SYSTEM REQUIREMENTS

6-1.505

The following are structures that require building sprinkler systems:

- A. All new commercial or industrial buildings (including basements).
- B. All multi-family residential structures (apartments, condos and time-share developments, etc.).
- C. All parking area structures (underground or aboveground).

SPRINKLER SYSTEM DESIGN

6-1.506

Base the building sprinkler system design on a certified flow test. A copy of the flow test shall be submitted with the improvement plans or shop drawings for city review. The drawings will be of uniform size (24-inch by 36-inch, or 30-inch by 42-inch) and drawn to scale. One set of the approved civil water final plans need to accompany these submittals. Also include on the working drawings any applicable city and IFC construction notes. The building sprinkler contractor shall submit 3 sets of shop drawings and a minimum of one set of calculations and supporting documents to the One Stop Shop for review by the Fire Department.

Include the following note on the final plans: "Installation will be per approved final plans. Any deviation from approved final plans will require written permission of the authority having jurisdiction."

The professional registrant in charge or fire code official may require a technical opinion and report prepared by a qualified party, and/or a professional registrant activities report containing all professional registrant duties as assigned by the State Board of Technical Registration with seal and signature of an Arizona Registrant, who is qualified in fire sprinkler design to accompany the plan submittal.

The professional registrant in charge is responsible to coordinate deferred submittals, professional registrant activities, technical assistance reports, modifications, alternative materials and methods, and to determine that the deferred submittal documents are in general conformance to the design of the building.

Inspections will be per National Fire Protection Association Standards (NFPA) 24 and as required by the Fire Department.

FIRE DEPARTMENT CONNECTION

6-1.507

If a remote Fire Department connection for a sprinkler system is required, it must be installed between 4 and 8 feet from the back of curb of a public or private roadway, on-site driveway or sidewalk. The location of the sprinkler system connection must be unobstructed and readily accessible to the Fire Department. Refer to the standard details in COS Interpretations and Applications of NFPA 13, 13R, 13D current adopted edition and COS Standard Detail No. 2367. This connection must also be within an appropriate distance of a fire hydrant as determined by the [Fire Department](#). Fire Department connections, whether remote or wall mounted, need to be identified and coordinated on the improvement plans and on the building plans site plan for relationship to fire lanes and fire hydrants. All Fire Department connections must be appropriately clear of glazing and other hazards and protected from vehicular damage. Refer to [SRC](#). Pavement markers for Fire Department sprinkler system connections must be provided as shown in COS Standard Detail No. 2363*.

AUXILIARY STORAGE TANKS

6-1.508

Water pressures and discharge flow required by the Fire Department will be for a minimum of 2 hours for commercial projects. A fire pump package installation may be required when the building's construction type, occupancy fire load commodities' classification, volumetric building areas, building height, and individual square footage areas per floor level produce a pressurized fire flow demand more than the water transmission mains capabilities. For [residential sprinkler](#) requirements, refer to the Scottsdale Interpretations and Applications of NFPA 13, 13R, 13D current adopted edition.

FINAL PLANS PREPARATION

6-1.600

General requirements for the preparation of final plans in the city are described in the Construction Plan Submittal Requirements in Section 1-2.100. The following information is required, in addition to the items noted in Section 1-1.000.

A. Ordinance Requirements

Upon development of the property for which city water service is desired and available, the developer will submit a plan for the water system prepared by a professional engineer licensed in the State of Arizona.

B. Design Policy

Any variance to these standards will require written approval from Water Resources.

GENERAL REQUIREMENTS

6-1.601

All extensions of the distribution system require pressure and flow testing. Include the results of the testing on the final plans cover sheet.

When a water line is to be connected to an existing system, the following note shall be placed on the final plans:

Contractor shall verify the location of the existing water line and type of material before proceeding with trenching.

SPECIFIC WATER PLAN REQUIREMENTS

6-1.602

For transmission and distribution lines, submit the following for city approval:

- A. For permitting purposes, include quantities on the cover sheet of the final plans for all items of work within the public rights-of-way, private street tract and public easements. The engineer will submit an estimate of probable cost for any pressure-reducing valve assemblies to establish those permit inspection fees.
- B. Station water lines along the centerline of the street or the pipe. Profile all water lines 12 inches and larger with line gradients and elevations, showing in profile the finish ground elevations over the water line where the water line is constructed outside of paving, or show in profile the finish pavement design elevations where the water line is constructed under paving.
- C. Where water lines cross sewer lines, SDs or drainage culverts show the relationship in both plan and profile with minimum clearances dimensioned. Identify all pipes, valves and appurtenances, etc.
- D. Identify water line service locations with a meter station and offset.
- E. Show meters to scale.
- F. Drawings shall show all utility locations, sizes, easements, rights-of-way and other structural features of the water line. Note pressure reducing valve settings and sizes on the plan.
- G. Show in plan view all easements, including the county recording numbers.

All construction documents will be prepared by a registered professional civil engineer licensed in the State of Arizona under the provisions of Arizona Revised Statutes (A.R.S.) Sec.32:141-145.

Booster Pump Stations and Reservoirs require separate plans submittals.

REVIEWS AND APPROVALS

6-1.603

All final plans that include connection to or extension of the city's water system, or on a system that is to be dedicated to the city, must be submitted to the One Stop Shop for review and approval. Plan review fees must be paid at the time of plan submittal. No final plans will be submitted to the city unless accompanied by a copy of the fire flow test results, or, when stipulated, the accepted basis of design report.

MCESD approval is required, prior to approval of final plans by Plan Review Services, when extension of the public water system is proposed. No permits for public water line construction will be issued until the owner or developer has provided the necessary easements or right-of-way. The instruments of dedication must be approved and submitted to the city for recording at the Maricopa County Recorder's Office.

AS-BUILT DRAWINGS

6-1.700

At a minimum, record drawings shall represent the as-constructed information noted in Section 6-1.602.

Plans information, changed or unchanged, shall be noted with a bold A.B. lettered next to the item. Lettering shall be legible and a minimum 1/8-inch height

The pipe material installed shall be indicated in both plan and profile. Any pipes, conduits or structures abandoned, removed, or discovered during construction shall be shown and noted as such.

Chapter 7

WASTEWATER

7

This chapter provides ordinance, policy, and standards establishing design criteria for constructing and modifying sanitary sewer (SS) systems to be owned and operated by the city, and for private systems. It provides guidance on agreements, preparation of design reports and design of sewer collection systems and final plans preparation.

GENERAL INFORMATION

7-1.000

A. Ordinance Requirements

Developers are required to install at their expense, all improvements necessary to provide wastewater service to their development. This includes any SS lines, lift stations, force mains or other facilities, and the payment of all required fees.

Refer to the Scottsdale Revised Code ([SRC](#)), Section 49-73.

Developers must also adhere to the city's requirements for extension of the city's wastewater system to newly developed areas and subdivisions inside the city's service area. Refer to [SRC](#) Section 49-212.

A Professional Engineer (civil or sanitary) currently registered in the State of Arizona is required to analyze the wastewater generation from a proposed development and determine its impact on the city's wastewater collection system. This analysis is typically required from the development to a point on the downstream system where the engineer can certify compliance with a master plan previously accepted by the city. The City of Scottsdale (city) is responsible for analysis of SS lines shown in the city's Integrated Wastewater Master Plan.

B. Design Policy

It is strongly advised that developers and property owners verify the need for any sewer extensions necessary to provide service to a site and comply with the extension/frontage requirements of the Code.

Available Resources:

1. [Public Records Request](#) – obtain existing utility maps and as-built drawings.
2. [SRC](#) – generally Chapters 47 through 49
3. [Maricopa Association of Governments \(MAG\) Uniform Standard Specifications and Details for Public Works Construction](#).
4. The [Scottsdale supplements to the MAG standards and details](#)
5. [City's website](#)
6. A city civil plans examiner and/or city water resources engineer can confirm the need for any required extension or condition for water service.
7. Water Resources Planning and Engineering – 480-312-5685

EPA REGULATIONS

7-1.001

The United States Environmental Protection Agency (EPA) requires the city to develop and implement a program to control discharges that might harm the Publicly Owned Treatment Works (POTW). The program establishes local discharge limits for non-residential users and provides a permitting process based on the users' discharges and types of businesses. Details of the program and requirements are found in the SRC: Article IV of Chapter 49; Water, Sewers and Sewage Disposal. Specific information may be obtained by calling the Water Resources Department at 480-312-5685.

ARIZONA DEPARTMENT OF ENVIRONMENTAL QUALITY (ADEQ) REQUIREMENTS

7-1.002

Design Policy

Maricopa County Environmental Services Department (MCESD) is required to review and approve all public SS line extensions and construction of wastewater-related facilities within the city's service area, prior to the city approving the final plans. Engineering Bulletin No. 11, "Minimum Requirements for Design, Submission of Plans and Specifications of Sewage Works" published by ADEQ and Arizona Administrative Code, "Title 18 - Environmental Quality," contain specific requirements for submittals, approvals and notifications when extension of a public SS line is proposed. Some of the provisions are outlined below. The developer is responsible for reading and complying with all regulations and requirements.

- A. Prior to city approval of final plans, the developer will submit a cover sheet for the improvement plans with a completed signature and date of approval from the MCESD. A city water resources engineer will provide a letter to comply with the requirements of Arizona Administrative Code Section R18-9-E301. 4.01.
- B. Before commencing construction, the contractor or developer will provide documentation to the city public works inspector that a Certificate of Approval to Construct and/or Provisional Verification of General Permit Conformance has been approved by MCESD. Contact MCESD at 602-506-6666 with any questions.
- C. Before building permits are issued, the developer will submit to the city public works inspector a Certificate of Approval of Construction and/or Verification of General Permit Conformance signed by MCESD.
- D. Before Inspection Services issues a Letter of Acceptance, the developer will deliver to the city's Public Works Inspector an acceptable set of full-size 4-mil as-built mylars of the improvements.

PRIVATE WASTEWATER FRANCHISES

7-1.003

Portions of Scottsdale's municipal service area are served by private wastewater franchises. Figure 7-1.1 delineates these areas. Franchise lines constructed within city right-of-way (ROW) will require an agreement between the wastewater company and the city.

Applicable review fees must be paid when the city reviews franchise sewer system plans. When submitting final plans, the developer must provide written documentation that the franchise company has reviewed and approved the SS lines within its service area or jurisdiction. A note must be placed on the final plans stating responsibility for operation and maintenance.

The city cannot provide wastewater service within the service area of private wastewater franchise without an agreement.

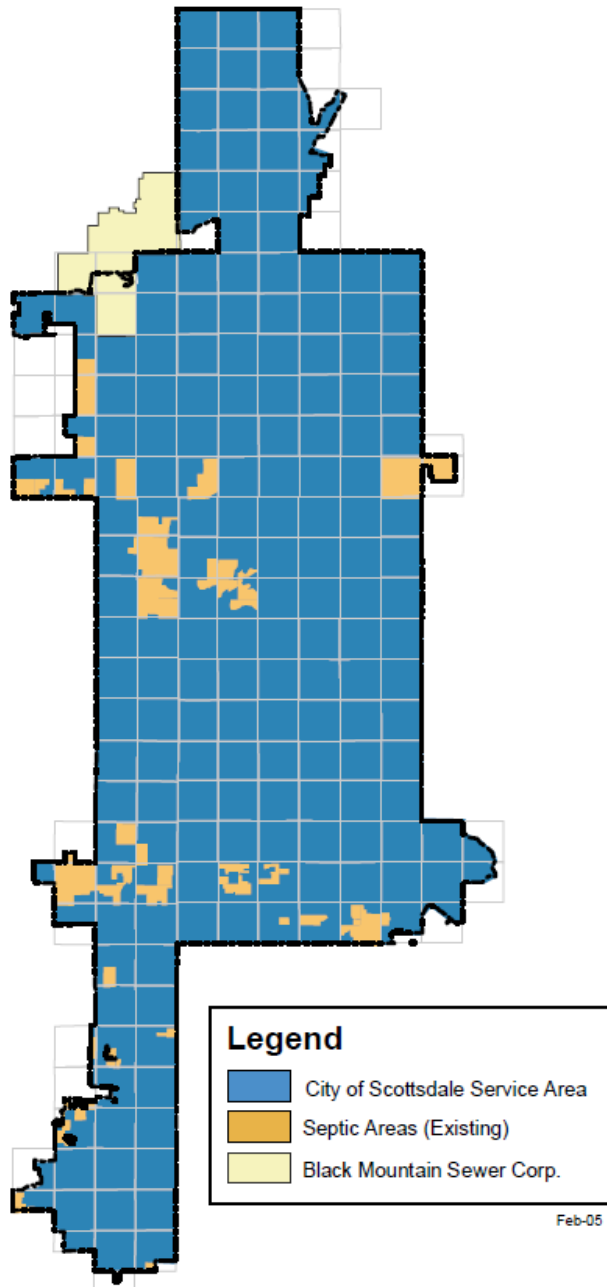

FIGURE 7-1.1 WASTEWATER SERVICE AREAS

AGREEMENTS

7-1.100

Developers and property owners who install improvements to the public wastewater system may be eligible to request a credit, oversize or payback agreement with the city allowing for partial reimbursement of costs to design and construct those improvements.

Developers who construct wastewater system improvements may receive credit for such construction; see SRC per Section 49-82, 49-83, and 49-84. The city has specific programs to provide for reimbursement agreements with developers or property

owners and for the collection of line payback charges and for the oversizing of wastewater lines, refer to SRC, Section 49-212.

CREDIT AGREEMENTS

7-1.101

Credit agreements are established to compensate a developer for installing system infrastructure that has been identified in the city's Capital Improvement Plan (CIP) and/or included in the most recent infrastructure improvement plan or long-range master plan. Credit agreements are set up through the Water Resources Department and are to be identified in the developer's master plan.

OVERSIZE AGREEMENTS

7-1.102

Oversizing Agreements allow the city to compensate developers for the cost to install a SS line larger than what is minimally required to serve the development. Oversizing is requested by the Water Resources Department when a larger line is necessary to meet the needs of additional properties upstream of a development. All oversizing projects involving city funds must have an oversizing agreement and must meet all the city requirements. The city can only participate in the cost of oversizing when there are sufficient funds in the Capital Improvement Plan (CIP) budget and the amount does not exceed the limitations set forth by the Arizona Revised Statutes, Title 34, Article 2, Paragraph 201.D. If sufficient funds do not exist, the oversized lines will be installed at the developer's cost. Oversizing agreements are set up through the Water Resources Department.

PAYBACK AGREEMENTS

7-1.103

Developers may request a Payback Agreement when constructing SS lines across frontages of parcels not currently receiving wastewater service from the city. If the city accepts an application for a Payback Agreement, a pro-rated cost of the SS line may be collected by the city and returned to the developer as set forth in the City Code. Line extension payback agreements are set up through the Water Resources Department. For questions or details on procedures to initiate an agreement, contact the Water Resources Department.

The [Extension Participation Program](#) may be available to single-family property owners required to public extended public sewer lines to their lot for service.

WASTEWATER SERVICE AGREEMENTS

7-1.104

The County's Sewer Service Agreement form should be completed by the developer's engineer and submitted or emailed for signature to the Water Resources Department and the Solid Waste Management Division. It is the owner's responsibility to obtain these signatures from the respective city divisions. The agreements will not be signed prior to the city approving the final plans. Following is specific information regarding the city's municipal wastewater system and the appropriate identification numbers:

Water Campus – Wastewater Treatment # 37-024

Gainey Ranch – Wastewater Treatment # 37-160

System Name: City of Scottsdale Water Campus

Address: 8787 E. Hualapai Dr., Scottsdale, AZ 85255

The following identification number relates directly to that portion of the city's wastewater system that is not treated at the Water Campus or Gainey Ranch. This area is generally south of Doubletree at Scottsdale Road, south of Via Linda at Pima Road and excludes the Hayden corridor to Frank Lloyd Wright Blvd:

General SS collection system # 37-011

IN-LIEU PAYMENTS

7-1.105

At the sole discretion of the Water Resources Department, an in-lieu payment may be accepted as a developer contribution satisfying the frontage extension requirements of the ordinance provided:

- A. An existing or future public sewer line fronts, or will front, a portion of the property; and
- B. An anticipated land division and/or rezoning of an upstream or downstream property may impact the size or desired alignment of the sewer line, or the Water Resources Department determines that a design cannot be sufficiently defined at time of application.

All in-lieu estimates are subject to review and acceptance by the Water Resources Department and shall include itemized amounts for design, permitting, construction, inspection, and administration based on current costs from the city's Capital Project Management (CPM) program, Master Plan, or Infrastructure Improvement Plan. In-lieu payments are to be made at the city's One Stop Shop when applying for either an encroachment or a building permit or prior to final plat approval for subdivisions.

DESIGN REPORTS

7-1.200

Water and (/or) Wastewater Basis of Design (BOD) reports for new development, redevelopment, or modifications may be required as described below.

Note that for larger planned communities, phased developments, and rezoned properties may be stipulated for a more extensive Water Master Plan to evaluate offsite water infrastructure and implications and requirements for phased planning and construction. Contact the Water Resources Department to discuss offsite and onsite requirements and the necessary content for a specific Water Master Plan.

- A. When is a water and/or wastewater BOD Report required?
 1. Except in those cases as described below, separate water and wastewater BOD reports shall be required to be submitted, reviewed, and ultimately accepted as "Final" by Water Resources for all new residential, commercial, or industrial development or redevelopment that may impact water and wastewater physical infrastructure, capacity, or other factors. Note that, in some cases, only a water or wastewater BOD may be required.
 2. New development or redevelopment shall not require submittal of a formal BOD report(s) when officially directed as such by Water Resources. This is typically applied in cases where there is little to no concern regarding the impact on water and/or wastewater capacity created by the new development/redevelopment, and no special engineering or planning accommodations or analysis is anticipated to be required to supply water and sewer service in accordance with city requirements.

3. Note that Water Resources may stipulate additional supplemental information in lieu of, or in addition to, a BOD report to satisfy any concerns or questions they may have.
4. New development conforming to the compound criteria listed below may not warrant submittal of a BOD report(s):
 - a. A single proposed meter and service line less than or equal to 1-inch in diameter (for residential subdivisions up to 4 homes/units with individually dedicated meters meeting this criterion qualify i.e. a proposed shared meter requires review), and;
 - b. No newly proposed public or private pipeline extensions or modifications of the city's existing public water or wastewater pipelines are required i.e. only typical domestic service line/lateral extension and connection to existing public water and sewer is required, and;
 - c. No exceedance of existing building heights found in the local area (within less than a quarter mile) located at the same topographic elevation and connected to the same water pressure zone. If no comparison buildings are available for evaluation contact Water Resources for information, and;
 - d. The proposed development is:
 - i. Residential or;
 - ii. Commercial if the fire hydrant(s) servicing the property is directly connected to a looped portion of the existing water distribution system or to an existing 8-inch diameter dead-end water line measuring less than 250 feet as measured from the looped distribution system connection point to the servicing hydrant. This distance is reduced to 50 feet if the dead-end line is 6-inch diameter.
Notes: When there is doubt on the applicability of these criteria confirm with the Water Resources Department; guidance on the BODs will generally be provided during the pre-application meeting; any proposed industrial development shall submit BODs.
 - e. Redevelopment conforming to the compound criteria listed below may not warrant submittal of a BOD report(s):
- A. All proposed/required meters, and/or service lines, are less than or equal to the existing sizes (to determine the estimated revised meter size a water fixture flow rate analysis may be required), and;
 1. There are no newly proposed zoning changes or significant changes in building use that would impact water or wastewater demands, and;
 2. No newly proposed public or private pipeline extensions, modifications, or new connections to, the city's existing public water or sewer pipelines are required i.e. the redevelopment uses the existing water-sewer service lines/laterals and existing connection points, and;
 3. No changes to the existing building height, and;
 4. Minimal changes to existing building square footage i.e. less than 10%, and;
 5. No proposed new additional or increased high water or wastewater demand features e.g. pools, kitchen, public bathroom, change to fire suppression and firefighting demand, etc., and;

6. The proposed development is:
 - a. Residential or;
 - b. Commercial if the fire hydrant(s) servicing the property is directly connected to a looped portion of the existing water distribution system or to an existing 8-inch diameter dead-end water line measuring less than 250 feet as measured from the looped distribution system connection point to the servicing hydrant. This distance is reduced to 50 feet if the dead-end line is 6-inch diameter
 Note: When there is doubt on the applicability of these criteria confirm with the Water Resources Department; guidance on the BODs will generally be provided during the preapplication meeting; any proposed industrial development shall submit BODs.
- B. Are there different stages of the water and sewer BODs and at what development stage are they typically submitted?
 1. Generally, and when required, preliminary BODs are required to be accepted during rezoning.
 2. Generally, and when required, final BODs are required to be submitted and approved during the preliminary plat (PP) case or development review (DR) case prior to approval by the Development Review Board (DRB).
 3. Note that Water Resources may stipulate additional supplemental information in lieu of, or in addition to, a BOD report to satisfy any concerns or questions they may have.

PRELIMINARY BASIS OF DESIGN REPORTS

7-1.201

Preliminary basis of design reports will evaluate a site's existing and proposed sewer demands to determine if adequate line capacity exists to sewer the development or if additional infrastructure will be required.

A. Preliminary BOD Report Format

1. The Preliminary BOD report(s) shall generally include the following items:
2. Basic text description of existing conditions, proposed development and relevant details, and proposed utility modifications.
3. An estimate of existing and proposed sewer demand.
4. A preliminary site/utility plan showing the following:
5. Proposed building(s) and details: units, square footages, finished floor height, etc.
 - a. Onsite sewer line layout with relevant appurtenances and site features e.g. manholes, service laterals, clean outs, taps, etc.
 - b. Existing utilities to the extent possible to demonstrate appropriate water or sewer routing
 - c. Proposed connection to existing water and sewer (extend from building)
 - d. Any proposed new utilities or modifications, especially water and sewer
 - e. The applicant should only show information that has been field verified or gone through preliminary design i.e. no purely conceptual layouts.
1. Any additional analysis determined necessary by Water Resources will generally be discussed in the pre-application meeting but may also be required after the preliminary BOD submission and may include requirements

to complete tasks such as hydraulic analysis/modeling and offsite analysis so that any resulting requirements can be accurately stipulated.

2. Note that Water Resources will require revisions and resubmission of preliminary BODs that do not meet the necessary requirements

B. Report Submittal Requirement

Final Basis of Design Reports must be reviewed and accepted by the Water Resources Department prior to approval by the DRB. Final Water BODs shall provide an analysis of a development's impact on the local wastewater distribution system and verify conformance with city requirements. These reports are reviewed and accepted by the Water Resources Department then utilized by Plan Review as support for their review of the formal submitted construction drawings/plans. The report's objectives are to demonstrate the following (as applicable):

1. Design conformance with the city's current Integrated Wastewater or Water Reuse Master Plan
2. Prove that there are no hydraulic or technical limitations or deficiencies with the proposed design
3. Conformance with city's design and development criteria and standards

The Final BODs shall generally include the following items:

1. All relevant information required for a preliminary BOD as-noted above but updated to reflect final design status.
2. An updated sewer flow monitoring data if current data is more than 1 year old.
3. Sewer hydraulic modeling information and results as detailed below.
4. Updated Final site/utility plan with the elements described under the preliminary BOD section above.
5. Any information related to comments or items the Water Resources Department noted or required on the approved preliminary BOD (if one was submitted)
6. Note that the Water Resources Department will require revisions and resubmission of Final BODs that do not meet the necessary requirements.

FINAL BASIS OF DESIGN REPORTS

7-1.202

Final Basis of Design Reports shall provide an analysis of a development's impact on the local sewer system. These reports are reviewed and accepted by the Water Resources Department then utilized by Plan Review staff as support for their review of the construction drawings. The report's objectives are to demonstrate design conformance to the city's current Water Reuse Master Plan and/or established local conditions.

A. Design Policy

A Professional Engineer (civil or sanitary) currently registered in the State of Arizona must analyze new development that will impact the city's sewer system. The effects of multiple scenarios shall be evaluated to ensure that sufficient capacity is available per the pipe design criteria described elsewhere in this chapter and that the proposed sewer system design and sizing are adequate for

the development. The Final BOD Report shall provide supporting map detail to serve as a master utility plan for the project.

B. General Final BOD Report Format Guidelines

1. Digital submissions of all documents are preferred as single, combined, and indexed Portable Document Format (PDF) files.
2. If hard copies are submitted, then two BOD report copies shall be submitted as letter-sized (8 1/2 x 11) and comb bound.
3. Provide a table of contents.
4. Maps and other supporting materials shall be 11x17 and attached as an appendix at the end of the report.
5. Reports must be sealed, signed, and dated on the cover by a Professional Engineer (civil or sanitary) currently licensed to practice in the State of Arizona.

C. Report Cover & Vicinity Map

Covers shall include:

1. The development's name, full address, and city case number.
2. The developer/owner's name, address, and phone number.
3. The engineer or design firm's name, address, and phone number.
4. The original BOD submittal date and any subsequent revision dates.
5. A vicinity map to identify the project's location with respect to major cross streets and city quarter- section (alternatively this can be placed on the first page of the report after the TOC)

D. Introduction

1. Summarize the proposed development including the number of residential units, square footages of non-residential development and intended use, and related site improvements.
2. Summarize any previous site development.

E. Existing Conditions

1. State the existing zoning and land use.
2. Describe the existing, topography, vegetation and landform features.
3. Include a description of existing utilities in the vicinity.
4. Summarize and attach the results of any certified sewer flow monitoring.

F. Proposed Conditions

1. Describe the proposed connection(s) to the city's sewer system.
2. Describe general depth of the sewer to accommodate the building pads.
3. Describe any proposed drop structures and measures taken to minimize development of odors.
4. State reasons for any shallow or steep sewer slopes approaching the allowable sewer grades stated elsewhere in this chapter.
5. Describe the need and method of sizing for any grease or sand/oil interceptors.
6. Address maintenance responsibilities of the proposed sewer system.

G. Required Design Documentation/Computations/Hydraulic Modeling

1. Include a discussion of which design procedures, policies and methodologies will be incorporated into the engineering of the wastewater system.
2. List the title and version of any software used in the design analysis.

3. Base wastewater flows on the unit demands listed in Figure 7-1.2 or other sources acceptable to the Water Resources Department. Verify any variance from the stated design flows with the Water Resources Department.
4. Give attention to wastewater peaking factors used for restaurants or specialty developments.
5. For developments that will have a swimming pool(s) or water features, provide calculations that show the backwash or drain rate and include in the evaluation of the wastewater collection system.
6. Calculated pipe data – include ID, upstream and downstream nodes, invert elevations, pipe material, slope, length, diameter, Manning's n-value, peak flow, flow depth, flow depth/diameter ratio, actual flow velocity, full flow design capacity and average pipe cover.
7. Provide calculations for the sizing of grease interceptors or sand/oil interceptors.
8. Include a scour analysis when crossing washes with flow greater than 499 cfs.

H. Summary

1. Summarize the proposed sewer improvements stating that all the city's design standards and policies have been met or note why the developer is requesting any variance or exception.
2. Include a brief project schedule indicating the proposed start and completion of the development's improvements.
3. State any intent to request a credit, oversize or payback agreements along with a description of the applicable sewer infrastructure.

I. Supporting Maps

1. Include a scaled site plan showing all existing and proposed utility lines and all existing and proposed improvements including line sizes and service locations. Provide separate maps if site demolition involves significant removal of existing utilities and improvements.
2. Screen existing topography and clearly label all existing and proposed contours or provide spot elevations with sufficient information to evaluate pipe cover.
3. Indicate locations of grease interceptors or sand/oil interceptors.
4. Show, dimension and label all property lines, rights-of-way, tract and easement lines.

J. Submittals

Electronic BOD report submittals are preferred for both preliminary and final. Electronic submittal reports may be electronically submitted following the [digital plan submittal](#).

Counter submittal reports stipulated to be accepted by the Water Resources Department prior to submittal of improvement plans, shall be submitted to the One Stop Shop to the attention of the Water Resources Department or may be submitted electronically. Counter submittals require three copies of the report in addition to any previously redlined reports.

ADDITIONAL INFORMATION

7-1.203

Information regarding report requirements and the city's wastewater collection system may be obtained by contacting the Water Resources Department at 480-312-5685.

WASTEWATER FACILITIES

7-1.300

Lift stations and force mains are typically designed and constructed by the city through its Capital Improvement Program. Developers needing to construct these facilities must contact the Water Resources Department and request a meeting.

A. Ordinance Requirements

When wastewater service is not available, a septic system or alternative system acceptable to the Water Resources Department may be allowed with the approval of both the city and Maricopa County Environmental Services Department per SRC, Section 49-116.

B. Design Policy

Maricopa County Environmental Services Department and the city discourage the development of privately owned packaged treatment facilities designed to serve two or more lots.

Where lift stations are necessary, the engineer shall contact and schedule a meeting with the Water Resources Department to discuss design requirements, ownership, and maintenance responsibilities.

Wastewater facilities will be located on a tract or a lot dedicated to the city (conveyed by a general warranty deed) and accompanied by a title policy in favor of the city.

ON-SITE TREATMENT FACILITIES

7-1.301

The property owner is responsible for the design, construction, operation and maintenance of an on-site wastewater treatment facility (i.e. septic system or other). The city will not accept any type of on-site system for operation and maintenance. All on-site wastewater treatment facilities shall be designed and constructed compliant with the applicable requirements of the Maricopa County Environmental Services Department. Final plans submitted to the One Stop Shop will include the county's permit number for the on-site system.

LIFT STATIONS

7-1.302

Water Operations maintains a separate document outlining the design, specifications and materials required for a city owned and maintained wastewater lift station. Contact the Water Resources Department for additional information.

A. Site Selection

In selecting a site for a sewer lift station, consider accessibility, drainage patterns, visual impact, function and design constraints. The station's equipment must be protected from damage and remain operable during a 100-year flood.

B. Lift Station Design

Arizona Administrative Code, Title 18, Chapter 9, "Water Pollution Control," contains minimum requirements for a wastewater lift station. The city's has its own [lift station criteria, details and specifications](#).

FORCES MAINS

7-1.303

Force mains shall be located within a right-of-way, private street tract or utility easement. The line shall be located under pavement where possible.

A. Velocity Requirements

The flow velocity in the force main shall be between 4 and 6 feet per second (fps).

B. Materials of Construction

All pipe material used in design of the force main must have established American Society for Testing Materials (ASTM), ANSI, American Water Works Association (AWWA) or National Sanitation Foundation (NSF) standards of manufacture or seals of approval and shall be designated as pressure SS pipe. Force mains must be identified as such with marking tape 1 foot above the pipe. A cured-in-place liner (CIPP) shall be installed within the pipe for all installations of ductile iron pipe (DIP) where technically possible. Contact the Water Resources Department for alternative pipe materials and/or other types of approved lining and coating systems of DIP and fittings.

C. Air Release/Air Combination/Air-vacuum Valves

Air release valves designed for sewage works must be provided on force mains at all high points to prevent air binding. Refer to City of Scottsdale (COS) Standard Detail No. 2405. The engineer shall discuss the force main design with the Water Resources Department. The Water Resources Department may require that the engineer conduct a pressure transient analysis on the pipeline to determine the appropriate type and location of any transient mitigation measures or air-binding prevention valves.

D. Cleanouts

Lines 6 inches and larger shall provide two-way cleanouts every 1,300 feet or 1-way cleanouts every 650 feet. Single cleanouts must be provided at all horizontal bends oriented in line with the downstream pipe.

Lines 4 inches and smaller shall provide two-way cleanouts every 600 feet or 1-way cleanouts every 300 feet. Ninety-degree changes in direction are to be accomplished using two 45-degree bends with a 2-way cleanout located between the two bends. Refer to COS Standard Detail No. 2403.

E. Force Main Restraint

Force mains shall be constructed using mechanically restrained joints at the following locations:

All locations where a vertical realignment or horizontal bends are required;

Drainage wash crossings;

Air release assemblies;

Clean-out assemblies;

Through vaults or structures (not buried);

Where determined necessary by analyzing pipe segment separation forces and pipe connection and soil friction forces.

F. Line Separations

Where a force main crosses a water main or transmission line, protection must be provided as per ADEQ Engineering Bulletin No. 10 and the Arizona Administrative Code, Title 18, Chapter 9, "Water Pollution Control."

The minimum separation between the force mains and water lines should be 2 feet wall-to-wall vertically and 6 feet horizontally under all conditions. Where a force main crosses above or less than 6 feet below a water line, the force main shall be encased in at least 6 inches of concrete for 10 feet on either side of the water line or constructed using mechanically restrained joint DIP. No fittings or joints are allowed within 7 feet on either side of the water line at the crossing

G. Connection to Gravity System

Force mains should be swept down to the receiving manhole trough and aligned with the downstream pipe to minimize potential air stripping and turbulence.

Refer to COS Standard Detail No. 2402 for situations where line separation requirements necessitate a drop connection into the manhole. The engineer must evaluate the potential for odor to develop from a force main downstream of the receiving manhole. Backwater valves on downstream building service lines shall be specified where there is potential for gasses to strip from the waste stream. The valves should be located at or near the building cleanout and include provisions for access and maintenance by the property owner.

COLLECTION SYSTEM

7-1.400

This section describes the minimum requirements for extending the public wastewater collection system.

A. Ordinance Requirements

When a public SS line is located within 660 feet of the boundary of the subject property, extend the line to provide service to the property per SRC, Section 49-224. A separate private on-site wastewater treatment system shall be constructed for each lot only when a public wastewater system is not available per Section 49-116.

SS lines are required along the entire length of property line frontage whenever future upstream extension of the wastewater system is possible. The property line frontage is that portion of the property that abuts a street, public utility easement (PUE) or public rights-of-way. If a parcel to be developed has more than one property line frontage, the city may require a SS line be installed along the entire length of all frontages per SRC, Section 49-219.

Developers must install, at their expense, all on-site and off-site improvements necessary to serve their developments. This expense includes all required development fees per SRC, Section 49-72.

On-site SS lines to non-platted commercial shopping center developments must be privately owned, operated and maintained. Multi-family developments may elect to install public or private SS per SRC, Section 49-118.

When required by the city, users who discharge non-residential wastewater must install monitoring manholes per SRC, Section 49-96. Users discharging industrial wastes must install monitoring manholes and provide written notice to the Water Resources Department per SRC, Section 49-161.

Additions or reconstruction of more than 50 percent of the existing square footage of residential or commercial structures, or improvements that necessitate modification to an existing on-site wastewater treatment system, generally require compliance with all current ordinances and design guidelines relating to sewer line extensions per SRC, Section 49-117.

B. Design Policy

SS lines shall not be privately owned if a future connection to those lines can serve adjacent parcels.

When an existing SS is not available, planned developments and subdivisions shall install a dry sewer line conforming to all the design requirements for a public SS line. Use a permanent marking system to locate the capped ends of service line stubs. The design of interim on-site wastewater treatment systems shall be planned for future connection to the system when SS service becomes available. Wastewater systems must be designed to serve the ultimate population density expected in the tributary area. Design shall be in conformance with the current city's Water Reuse Master Plan. Where extension of the wastewater collection system is possible upstream of a subdivision, extend the SS through the subdivision to a point of connection on the platted boundary that will provide wastewater service to adjacent properties.

C. Design Standards

The engineer should be familiar with the Maricopa Association of Government's Uniform Standard Specifications for Public Works Construction and the COS Supplement to MAG Uniform Standard Specifications for Public Works Construction, including all applicable Standard Details. These documents contain construction related specifications and details that impact the design of water systems including trenching, bedding, backfill and pavement replacement, etc. Private wastewater systems must be designed in compliance with Arizona Administrative Code, Title 18, Chapter 9, and "Water Pollution Control".

MATERIALS

In selecting pipe material for SS lines, consider chemical characteristics of wastewater, velocity, potential for going septic, internal and external pipeline forces, infiltration, abrasion and potential for root infestation.

SS lines are to be vitrified clay pipe (VCP), polyvinyl chloride pipe (PVC) Standard Dimension Ratio 35 up to 15 inches in diameter or meeting ASTM F679 - T1 for diameters between 18 and 27 inches, or DIP with an approved lining. AWAA C-900 or C-905 pipe may be permitted in areas where mechanically restrained joint pipe is permissible for PVC installations and shall include the appropriate marking tape.

Submit any requests for consideration of alternative materials in writing to the Water Resources Department. Pipe material shall not change between manholes.

Where standard strength pipe is not structurally sufficient due to external loading, or 4 feet of pipe cover cannot be maintained, submit a written request with supporting

7-1.401

calculations to the Water Resources Department for permission to use extra-strength pipe, special bedding specifications, or alternative construction methods. The Water Resources Department must accept the request in writing prior to Plan Review's approval of the final plans.

Ensure that all types of pipe material used in design have established ASTM, ANSI, AWWA or NSF standards of manufacture or seals of approval and are designated for use with wastewater.

SYSTEM LAYOUT

7-1.402

Generally, SS lines constructed along a street grid should be aligned parallel to, and south or west of the street centerline. Lines should not cross the street centerline except in cases where curvilinear roadway alignments are encountered.

Public SS lines within commercial, industrial or multi-family developments must be located within drive aisles a minimum of 6 feet from any structure. Public SS lines will be located within tracts and/or sewer line easements. No private utilities are allowed longitudinally within a sewer line easement.

Curvilinear SS lines are not allowed. Developments with numerous curved streets should be discussed with the Water Resources Department to decide whether the city will consider a design report with water and sewer layouts in accordance with the following criteria:

- A. Water and SS lines will be placed under the paved section of the roadway within the area, from back-of-curb to back-of-curb.
- B. SS lines must maintain a minimum of 6-foot horizontal clearance to dry utilities per COS Standard Detail No. 2401.
- C. SS manholes are to be located at the approximate center of the drive lane.
- D. The water line and SS line shall run parallel to each other with 6 feet of separation between the pipe walls. Lines may cross the street centerline.
- E. Deflections in the SS line through manholes shall be designed to nominal fitting angles within standard tolerances and will occur at the same locations where the water line is deflected. Refer to Section 6-1.402 for related water system criteria.

DESIGN FLOWS

7-1.403

A. Residential

SS lines 8 to 12 inches in diameter will be designed using 100 gallons per capita per day (gpcpd) and a peaking factor of 4.

SS lines larger than 12 inches in diameter will be designed using 105 gpcpd and a peaking factor developed from "Harmon's Formula":

$$Q_{max} = Q_{avg} \times [1 + (14 / (4 + P^{1/2}))]$$

$$P = \text{Population} / 1,000$$

Residential densities are to assume 2.5 persons per dwelling unit. Multifamily densities exceeding 22 dwelling units per acre can assume 1.7 to 2.2 persons per unit.

B. Commercial and Industrial

Wastewater flows for uses other than those listed below shall be based upon known regional or accepted engineering reference sources approved by the Water Resources Department.

LAND USE	DEMAND (gpd)	DESIGN PEAKING FACTOR
<i>Commercial/Retail</i>	0.5 per sq. ft.	3
<i>Office</i>	0.4 per sq. ft.	3
<i>Restaurant</i>	1.2 per sq. ft.	6
<i>High Density Condominium (Condo)</i>	140 per unit	4.5
<i>Resort Hotel (includes site amenities)</i>	380 per room.	4.5
<i>School: without cafeteria</i>	30 per student	6
<i>School: with cafeteria</i>	50 per student	6
<i>Cultural</i>	0.1 per sq. ft.	3
<i>Clubhouse for Subdivision</i>	100 per patron x 2	4.5
<i>Golf Course</i>	patrons per du per day	
<i>Fitness Center/ Spa/ Health club</i>	0.8 per sq. ft.	3.5

FIGURE 7-1.2 AVERAGE DAY SEWER DEMAND IN GALLONS PER DAY & PEAKING FACTORS BY LAND USE

HYDRAULIC DESIGN

7-1.404

No public SS lines will be less than 8 inches in diameter unless permission is received in writing from the Water Resources Department.

SS lines shall be designed and constructed to give mean full flow velocities equal to or greater than 2.5 fps, based upon Manning's Formula, using an "n" value of 0.013.

To prevent abrasion and erosion of the pipe material, the maximum velocity will be limited to 10 fps at estimated peak flow. Where velocities exceed this maximum figure, submit a hydraulic analysis along with construction recommendations to the Water Resources Department for consideration. In no case will velocities greater than 15 fps be allowed.

Actual velocities shall be analyzed for minimum, average day and peak day design flow conditions for each reach of pipe.

The SS system shall be designed to achieve uniform flow velocities through consistent slopes. Abrupt changes in slope shall be evaluated for hydraulic jump.

The depth to diameter ratio (d/D) for gravity SS pipes 12 inches in diameter and less shall not exceed 0.65 in the ultimate peak flow condition. This d/D ratio includes an allowance for system infiltration and inflow.

The d/D for gravity drains greater than 12 inches diameter shall not exceed 0.70 for the ultimate peak flow condition. This d/D includes an allowance for system infiltration and inflow.

Measures to mitigate hydrogen sulfide shall be analyzed at manhole drops, abrupt changes in pipe slope or direction and at changes in pipe diameter.

MANHOLES AND CLEAN OUTS

7-1.405

Manholes in city streets shall be located near the center of the inside traffic lane, rather than on or near the line separating traffic lanes. Manholes shall not be in bike trails, equestrian trails, sidewalks, crosswalks or wash crossings. Manholes are required at all

changes of grade, pipe size, pipe material or alignment and at distances not to exceed those shown below:

PIPE DIAMETER (inches)	MAXIMUM MANHOLE SPACING (feet)
8 - 15	500
18 - 30	600
36 - 60	800
OVER 60	1300

FIGURE 7-1.3 MANHOLE SPACING

A. Manhole Base

Manhole bases shall be cast in place. The flow channel through the manhole shall be steel trowel finished to conform in shape and slope to the SS pipe. The manhole shelf should be brushed, or broom finished, with a slope of 1 inch per foot. The manhole bottom should be filleted to prevent solids depositions and channeled to ensure satisfactory flow to the lower invert.

B. Manhole Sections and Cones

All manhole sections and cones should be the precast concrete as detailed in the MAG Standard Detail No. 420, but without the manhole steps and/or cast in anchors for steps.

Manholes shall be 4 feet in diameter. However, if a manhole is more than 10 feet deep or the line is 15 inches in diameter or larger, the manhole shall be 5 feet in diameter. Manhole depth shall be defined as the distance from the design rim elevation to the lowest invert elevation.

C. Manhole Covers

Manhole covers are to be per MAG Standard Detail No. 424 and COS Standard Detail No. 2421.

D. Manhole Linings

Manholes will be lined or coated when constructed on SS lines 15 inches in diameter or larger or in other design situations where corrosive conditions are anticipated. Manholes receiving wastewater from force mains and private ejector lines must be lined. Manholes requiring linings or coatings shall be noted on the final plans.

E. Intersecting Lines within Manholes

Any DIP or pipe appurtenances used within the manhole shall be completely coated and lined with 100 percent solids epoxy to withstand the corrosive environment or substituted with an appropriate corrosion resistant material approved by the Water Resources Department.

All changes in horizontal direction, slope, material or size of the sewer line shall occur at a manhole. The horizontal angle formed between the two lines cannot be less than 90 degrees.

Manholes shall have a minimum 0.10-foot drop across the trough unless otherwise approved by the Water Resources Department. Where pipe size changes through a manhole, the top invert of the upstream pipe(s) will be equal to or higher than the top invert of the downstream pipe. In large trunk lines, inverts at junctions should

be designed to maintain the energy gradient across the junction and prevent backflow.

F. Drop Manholes

The difference in invert elevations between inflow and outflow lines shall not exceed one pipe diameter, unless a drop connection is installed. Drop connections shall be in accordance with MAG Standard Detail No. 426, modified as follows:

For drops up to and including 5 feet, use Type "A" drop connections, and

For drops greater than 5 feet, use Type "B" drop connections.

G. Manholes at Washes and Drainage Areas

Manholes must be protected from storm drainage and flooding conditions. SS lines will not be allowed in washes or drainage areas unless otherwise approved in writing by the Water Resources Department.

Manholes located within washes or drainage areas, when approved by the Water Resources Department, are to have bolted watertight covers to prevent inflow and the rim elevation should be a minimum of 18 inches above adjacent finish grade, refer to COS Standard Detail No. 2420. Design watertight manhole bases, barrels and grade rings and provide structural protection against scour from a 100-year storm flow. This protection may require encasing the entire manhole using a sonotube form or by constructing a monolithic manhole. The manhole should be designed by the engineer to meet the amount of protection as calculated by the flow conditions of the wash. The engineer is responsible to design a manhole to eliminate infiltration in wash areas.

H. Cleanouts

Cleanouts per MAG Standard Detail No. 441 may be used in place of manholes at the ends of laterals that cannot be extended and are less than 150 feet in length.

Cleanouts are required to allow for maintenance and inspection of the lines.

When a sewer line can be extended by others along the same alignment and grade, a cleanout may be permissible beyond 150 feet in length up to a maximum distance of 300 feet.

Service connections are not allowed at the ends of cleanouts. Service connections should be provided off the SS line a minimum of 2 feet downstream of the cleanout.

MONITORING VAULTS AND MANHOLES

7-1.406

A. Monitoring Vaults

The Water Quality Division has sole discretion when to require a developer to install a monitoring vault for testing wastewater flow and composition. Generally, properties in industrial land use areas with a projected wastewater discharge of 25,000 gallons per day will be required to install a monitoring vault per COS Standard Detail No. 2460.

B. Monitoring Manholes

The Water Quality Division has sole discretion when to require a developer to install a monitoring manhole. Generally, commercial developments that will use chemicals or solvents are required to install monitoring manholes.

Monitoring manholes shall be constructed per MAG Standard Detail No. 420 with a straight channel and no taps or bends for 10 feet upstream or downstream or as

approved by the Water Resources Department. Monitoring manholes on sewer services with a peak flow greater than 40 gallons per minute must be approved by the Water Resources Department.

Monitoring vaults and manholes shall be in a minimum 20-foot-wide easement that extends from the manhole to the existing public wastewater system and shall be designed for access always to city crews.

PIPE COVER AND SEPARATIONS

7-1.407

SS pipe should be installed at a depth sufficient to ensure gravity drainage of wastewater from each service line and should anticipate the lowest potential finish floor elevation for each building pad.

Pipe design shall allow for future extensions of service to adjacent parcels.

In no case shall SS lines be installed with less than 4 feet of cover over the top of the pipe, unless otherwise approved by the Water Resources Department.

All SS lines shall be designed to absorb superimposed live loads and backfill loads without damage to the pipe material or adverse effect to the pipe hydraulics. The engineer will specify minimum depths of cover to be provided during the construction of roadways or other grading over the pipe.

A. Separation of Water and SS Lines

Caution shall be taken in the design and construction of the SS lines to protect all water supplies from wastewater contamination. Horizontal and vertical separation of water and SS lines shall comply with Arizona Administrative Code, Title 18, Chapter 9, "Water Pollution Control", MAG Standard Detail No. 404-2 and COS Standard Detail No. 2401.

The minimum horizontal distance from a water line to a SS line will be 6 feet, wall-to-wall. The minimum vertical clearance of a water line crossing under or over a SS line will be 2 feet.

Where conditions prevent adequate vertical separation or where a water line must cross under a SS line:

Both the water and sewer line will be constructed for DIP with restrained joints, or, Where the existing water line is other than restrained ductile iron, the water lines shall be replaced with restrained DIP per MAG Standard Detail No. 404-2.

Where the existing or proposed sewer line is other than restrained ductile iron, the sewer line shall be encased in concrete per MAG Standard Detail No. 404-3.

B. Separation from Structures

SS lines will have a minimum of 6 feet of horizontal clearance from any structural footing or substantial improvement. Design will consider any structural load imposed on the pipe.

C. Separation from Other Utilities

For information about separation from other utilities refer to COS Standard Detail No. 2401.

D. Separation from Storm Drains and Culverts

SS lines crossing less than 2 feet below a storm drain (SD), culvert or under large structures, such as box culverts and bridges, will require the additional protection using restrained joint DIP or C-900/905 PVC with concrete encasement. SS lines

crossing over SDs and culverts should have a minimum of 1-foot vertical clearance and be adequately restrained.

DESERT WASH CROSSING

7-1.408

All desert wash crossings shall be constructed using restrained joint DIP or PVC encased in accordance with MAG Standard Detail No. 402. Bury requirements to place SS lines under washes or channels will be based upon the 100-year peak discharge in the channel or wash (Q_{100}). The minimum depth of bury below the design flow line of the channel or wash shall be per Figure 7-1.4.

100-year flow rate (cfs)	MINIMUM DEPTH OF BURY (feet)
1 to 49	5
50 to 99	6
100 to 499	7
Greater than 499	Scour depth based on scour analysis required

FIGURE 7-1.4 WASH CROSSINGS -- MINIMUM DEPTH OF BURY

Wash crossings with a 100-year flow above 500 cubic feet per second (cfs) shall have the scour depth estimated using Arizona State Standard Attachment (SSA) 5-96, Guideline 2, Level I, as published by the Arizona Department of Water Resources (ADWR). The engineer will estimate the depth of scour and design the top of pipe to be 3 feet below the estimated scour depth. The engineer will provide a detailed analysis of the scour depth with final plans for review and approval.

All pipelines that must be located within the scour zone or will not meet the minimum required depth of bury, as indicated above, shall be protected by installing a cut-off wall downstream of the pipeline to stabilize the scour depth to a minimum of 3 feet above the pipeline. The engineer shall design the cut-off wall and include details on the improvement plans. Plan Review will review pipe protection and scour stabilization requirements on a case-by-case basis.

GRAVITY SEWER SERVICE CONNECTIONS

7-1.409

The engineer shall make every effort to use existing SS lines that have been stubbed out to a property by previous construction. Where the use of a stubbed-out line is not feasible, the existing line shall be abandoned and permanently capped at the property or easement line. If the existing service line is connected to a manhole, the trough of the manhole will be rebuilt to conform to the active lines.

A. Minimum Diameters for Service Lines

- Residential: 4-inch
- Multi-family: 6-inch
- Commercial: 6-inch

B. Installation

All service line connections shall be installed perpendicular to the SS line in accordance with MAG Standard Detail No. 440-3 and extended to the right-of-way or edge of the utility easement and be marked. No bends in the service line will be allowed within the right-of-way or easement.

C. Location

Each lot or building must be provided with its own individual service line unless otherwise approved in writing by the Water Resources Department.

The service line location should be coordinated to avoid conflicts with other utilities or placement with driveway locations and should be located within the downstream 1/3 of the fronting SS line length.

Because water lines are located behind the curb in many locations, conflicts with SS service lines are possible. SS lines should be designed to allow for the SS service lines to pass under water lines with 12 inches of vertical clearance.

When it is not possible to maintain sufficient vertical clearance, or the SS service line will pass over the existing water main, the SS service line must be encased in concrete of 6 inches minimum thickness to 6 feet from each side of the crossing or DIP must be used for the same distance as MAG Standard Detail No. 404-2.

D. Service Line Connection to Large Diameter SS

SS lines 15 inches in diameter or larger, may be tapped only with a manhole.

Service lines into manholes may be angled, but the flow line of the service line shall not be more than 4 inches below the crown of the main sewer line.

E. Service Line Connections into Manholes on Small Diameter Sewer Lines

No more than 4 service lines may be made into any manhole on a SS line 12 inches in diameter or smaller. SS service line inverts will be not be more than 1 service line pipe diameter above the crown of the downstream SS line.

F. Service Line Connections at Cleanouts

SS service connections shall be located a minimum of 2 feet downstream of the cleanout structure.

G. Backwater Valves

A backwater valve shall be provided on service connections where there is potential for the migration of sewer gas into the service line and at locations where the finish floor is not 12 inches higher than the upstream manhole. Backwater valves shall be located on private property and shall be accessible for maintenance by the property owner.

EJECTOR SEWER SERVICE CONNECTIONS

7-1.410

Pressurized SS ejector systems are to be owned, operated and maintained by the property owner. The property owner's civil engineer is responsible for the design and hydraulic analysis of the pressurized system.

A. Connection of Individual Ejector to Adjacent Gravity SS Line

A SS service line per MAG Standard Detail No. 440-3 shall be constructed within the right-of-way or easement. The ejector line will connect into the gravity service line outside of the right-of-way or easement through the end of a service cleanout connection.

B. Connection of Individual Ejector(s) Downstream of a Property

The city does not support extending private pressurized ejector lines across the frontages of adjacent lots or properties. The developer or property owner shall request a meeting with the Water Resources Department to discuss available

options. Water Resources may approve the extension of individual private ejector lines across the frontages of adjacent properties where:

A private sewer system receives wastewater from ejector lines (the first downstream public manhole shall be coated or lined to prevent corrosion). Individual ejector lines from parcels run within a private sewer easement adjacent to any public right-of-way and utility easement. Spare conduits shall be provided and clearly labeled on a plan detail in the event one line becomes plugged or damaged.

Where individual ejector lines exceed 600 feet in length or have retention times exceeding 3 hours, the engineer shall evaluate the potential for odor problems. The city does not accept odor-absorbing materials in basket containment placed within manholes. Odor management will be incorporated using biofiltration processes.

GREASE, OIL, AND SAND INTERCEPTORS

7-1.411

Grease, oil and sand interceptors shall be provided for laundries, restaurants, automobile service facilities, car washes, parking garages and other similar facilities. The engineer should contact the Water Quality Division to determine if an interceptor is required and which type of interceptor is best suited for the proper handling of wastes. Interceptors shall be installed and maintained by the owner and made accessible to the city.

Each business, restaurant or establishment shall discharge to a separate interceptor. Each interceptor shall be shown to scale, stationed on the plans. The civil engineer shall coordinate with the mechanical engineer to assure the following are considered in the design of grease interceptors:

- A. Design is compliant to the current plumbing code as adopted by the city.
- B. Tanks size is appropriate for the maximum projected flow from the establishment and anticipates a 30 to 90-day maintenance schedule.
- C. Potential to develop odors.
- D. Separation from pedestrian areas or corridors.
- E. Avoid locating grease interceptor in parking garages, streets and under public parking spaces.
- F. Ease of cleanup after maintenance and pumping.
- G. Kitchen garbage grinders should be avoided, but if installed must be routed through the interceptor.
- H. Dishwashers equipped with booster heaters and or using water more than 140 degrees F shall not pass through an interceptor with less than 1,000-gallon capacity.
- I. Grease traps shall only be installed for ice cream shops, small coffee shops or sandwich shops.

For more detail contact the Water Quality Division at 480-312-8732.

TRACT AND EASEMENT REQUIREMENTS

7-1.412

All public SS lines located outside the public right-of-way or a private street tract must be placed within a minimum 20-foot-wide easement located within a dedicated tract unless approved otherwise by the Water Resources Department.

Trunk line sewers, sewers with depth more than 15 feet, and sewers located in difficult terrain may require easements wider than 20 feet. These easement widths will be determined by the Water Resources Department to meet access and maintenance needs.

The SS line shall be located a minimum of 6 feet from the edge of the easement. The easement will be accessible from a public right-of-way, will be free of obstructions, and will be accessible always to city service equipment such as vacuum trucks and backhoes. Areas in question will be approved in writing by the Water Resources Department. Water Resources may approve gates or removable type fencing across the easements. Plan Review will evaluate situations where encroachment into the easement with structural improvements such as screen walls and paving cannot be avoided on a case-by-case basis.

- A. SS line easements, located outside of paved areas, shall have a 10-foot-wide hardened path with a cross-sectional slope not greater than 10 percent. The hardened path will consist of native soil compacted to 95 percent to a depth of 1 foot from the existing or design surface, whichever is lower. Any revegetation within the easement will consist of low growing shrubs or plant material acceptable to the Water Operations Division. Trees may be located along the edge of the easement but not within 7 feet of the SS line as measured to the trunk of the tree. Attention shall be given to the aggressive nature of vegetation roots.
- B. SS easements located on private property without a dedicated tract will require written permission from the Water Resources Department.
- C. If access across a sewer easement is not practical, the Water Resources Department will review access to manholes for cleaning and maintenance purposes on a case-by-case basis. City equipment requires a turn-around. Hammerhead turnaround configurations are acceptable as are cul-de-sacs.
- D. A copy of any written approval from the Water Resources Department shall be submitted with the final plans.

EASEMENT RELEASE OR ABANDONMENT REQUIREMENTS

7-1.413

When a property owner or developer believes a SS line easement or portion thereof is no longer required by the city, abandonment may be requested by completing and filing an application through the city's One Stop Shop,

www.scottsdaleaz.gov/planning-development/forms.

After completing and filing the application, the property owner or developer will send a letter or email requesting release of the easement to the Water Resources Department with the following exhibits attached:

- A. A detailed map highlighting the easement to be released and locations of existing sewer lines shown in reference to the easement.
- B. If existing sewer lines are to be abandoned, a detailed civil plan prepared by a professional engineer licensed in the State of Arizona must be supplied describing the method of abandonment and any necessary relocation of the sewer lines.

The Water Resources Department will issue a determination recommending approval or denial of the release request and any stipulations that may be required.

The determination will be attached to an Application for Release of Easement and will be submitted by the applicant to the One Stop Shop for subsequent processing by the city.

Failure to comply with the above process will result in a denial of the request. Where replacement rights are requested by the city, the city will not relinquish existing rights until the replacement rights have been granted.

PRIVATE SEWER LINES

7-1.414

Wastewater collection systems within non-subdivided commercial properties shall be designed as private systems compliant to the city's current plumbing code and Arizona Administrative Code, Title 18, Chapter 9, "Water Pollution Control". Privately owned and maintained SS lines shall not be in the street right-of-way or in a PUE.

ALTERNATIVE SEWER SYSTEMS

7-1.415

Developers or property owners may request the Water Resources Department to consider the design of alternative wastewater systems upon their engineer's determination that conventional gravity or forced SS systems cannot provide adequate service to their development. Contact the Water Resources Department for information regarding alternative sewer designs.

If an alternative wastewater system is acceptable to the Water Resources Department, the design concept will then be coordinated with the Maricopa County Environmental Services Department.

INCIDENTAL CONNECTIONS

7-1.416

Illicit discharges in violation of Arizona Pollutant Discharge Elimination System (AZPDES) are the responsibility of the property owner. Upon approval from the Water Resources Department, certain managed illicit discharges may be directed to the SS system provided:

- A. The developer provides to the Water Resources Department a written description of the illicit discharge and a statement of other methods of containment considered and why they were not implemented.
- B. Provisions are made to prevent the inflow of any storm water into the SS.
- C. The Water Resources Department reviews and approves details of connection to the SS.
- D. The rate of discharge does not exceed that identified in the sewer basis of design report or on the improvement plan.

Developers are encouraged to provide mop sinks and inside rooms for cleaning floor mats and containers. Outside wash-down areas must protect floor drains from storm water inflow utilizing overhead covers, curbing and grading. Wash-down areas shall be directed to a grease interceptor or sand/oil separator.

FINAL PLANS PREPARATION

7-1.500

Construction Plan Submittal Requirements for the preparation of final plans in the city are described in Chapter 1. This section supplements the requirements of Chapter 1.

A. Ordinance Requirements

Upon development of property for which city wastewater service is desired and available, the developer shall submit a plan for the wastewater system prepared by a professional engineer licensed in the State of Arizona per SRC, Section 49-122.

B. Design Policy

Any variance to these standards will require written permission from the Water Resources Department.

C. Design Standards

Project notes that apply to construction on the city's wastewater system are required on each set of final plans that include improvements to the city's wastewater system or a wastewater system that is to be dedicated to the city.

SPECIFIC SEWER PLAN REQUIREMENTS

7-1.501

The following paragraphs highlight requirements for the preparation of wastewater final plans that are to be submitted to the city for approval.

- A. All SS lines will be shown in both plan and profile and pipe material called out.
- B. Each manhole will have a unique identifier and be labeled in both plan and profile.
- C. SS line stationing will be along the centerline of the pipe.
- D. Final plans will show all proposed service line connections with stations and dimensions or offsets from street centerline. Dimension typical separation dimensions from the water service lines.
- E. Concrete encasement will be shown in both plan and profile. The beginning and ending stations of the encasement shall be called out.
- F. If a line is to be connected to an existing system, the following note should be placed on the final plans: "Contractor shall verify the location and elevation of the existing SS line before proceeding with trenching."
- G. Both slope and elevation must be shown on all proposed SS lines stubbed out for future extension.
- H. Where SS lines cross water lines, SDs or drainage culverts, the clearances will be shown in profile.
- I. For permitting purposes, quantities for all items of work within the public rights-of-way and PUEs will be included on the cover sheet of the final plans.
- J. SS service line invert elevations will be called out for all final plans. All service line connections shall be shown on the final plans with the ends of any capped service lines located by station, offset or dimension.
- K. The drawings will show all utility locations, sizes, easements, rights-of-way and other structural features affecting the SS line.
- L. Lift station plans will show all invert elevations, structural elevations, existing and finished grades, control setting elevations, structural design of the wet well and dry well, valves and piping, surge control devices, pump suction and discharge details and any other details necessary to provide construction of the design.
- M. Plans and profiles of force mains will show size, invert and grade elevations, material, existing and proposed utility locations and any other necessary details.
- N. Private and dry SS lines will be noted as such on the final plans set. The responsibility for operation and maintenance of private sewer systems will be stated on the final plans.

- O. Easements within tracts will be shown and labeled in plan view. Existing County recording numbers shall be shown on the final plans.
- P. Final plans must comply with any design review or preliminary plat stipulations and any accepted wastewater basis of design report.

All plan documents for SS lines and/or wastewater treatment works will be prepared by a registered civil professional engineer licensed in State of Arizona under the provisions of Arizona Revised Statutes (ARS) 32:141-145.

Additional requirements for the preparation of final plans in the city are presented in DS&PM Chapter 1, Section 1-2.100.

REVIEWS AND APPROVALS

7-1.502

All final plans that include work on the city's wastewater system or on a system which is to be dedicated to the city, must be submitted to the One Stop Shop for review. Plan Review fees must be paid at the time of plan submittal.

No final plans will be submitted unless accompanied by a copy of the accepted basis of design report, when one is stipulated for the project. Maricopa County Environmental Services Department approval is required prior to approval of final plans by Plan Review. No permits for improvements to the public wastewater system will be issued until the owner or developer has provided all necessary easements or right-of-way. These instruments of dedication must be approved and submitted to the city for recording at the Maricopa County Recorder's Office.

AS-BUILT DRAWINGS

7-1.600

At a minimum, record drawings shall represent the as-constructed information noted in Section 7-1.501.

Plans information, changed or unchanged, shall be noted with a bold A.B. lettered next to the item. Lettering shall be legible and a minimum 1/8-inch height.

The pipe material installed shall be indicated in both plan and profile. Any pipes, conduits or structures abandoned, removed, or discovered during construction shall be shown and noted as such.

Chapter 8

STREETSCAPES, PARKS & TRAILS

8

This chapter provides guidance for design and approval of landscaped areas within streetscape corridors, developing park master plans and individual park designs and creating non-paved, non-motorized and shared use trails throughout the city.

8-1 LANDSCAPED MEDIANS/ROWS

8-2 PARKS

8-3 NON-PAVED TRAILS

Section 8-1

LANDSCAPED MEDIANS & ROWS

8-1

This section is intended to aid designers in developing hardscape, landscape, irrigation and general aesthetic improvements for areas within the city's streetscape corridors. It recommends plants for special character areas, provides landscape, irrigation, design, and sight distance guidelines and requirements for inspections and as-built submittals.

GENERAL INFORMATION

A. Median and Streetscape Character Areas

There are different median design standards for each character area within the city; contact the City of Scottsdale's (city's) Plan Review office to determine which character area designation to use for each specific project.

Medians within Commercial Cores as identified in the General Plan will be allowed a higher percentage of plant coverage with the plant materials for the character area in which they are located.

B. Downtown and Urban Character

The Downtown and Urban Character classification is given to the areas of the city in which pedestrian comfort is a primary consideration. When designing these areas concentrate on elements such as covered walkways, shade, decorative paving, and landscaping so that a comfortable setting can be created for this pedestrian area.

Balance the use of plant material with decorative paving (stamped concrete, exposed aggregate, and pavers, etc.) to minimize the exposure of decomposed granite.

Median landscaping in the Downtown couplet system must conform to specifications in the Downtown Urban Design and Architectural Guidelines. Plant palette and quantities must also conform to the Downtown Urban Design and Architectural Guidelines.

Downtown guidelines can be found online through the city's website, www.scottsdaleaz.gov/old-town.

C. Suburban Character

The suburban character applies to areas of the city where compatibility should be achieved between pedestrians and transportation routes within a medium density development pattern. Using trees that are native and/or desert adapted and that achieve a broad, dense canopy is encouraged for the main theme of the streetscape. Separating pedestrians from vehicular traffic can be accomplished through landscape areas and sidewalk alignment.

Use decomposed granite, exposed aggregate, and grouted riprap in place of decorative paving.

Plant palette should begin to incorporate more arid-type materials or desert adapted, as shown in Section 8-1.102.

D. Transitional Arid Character

For areas of the city where the development pattern is medium to low, and the streetscape serves as a buffer between traffic and adjacent land uses, the transitional arid character classification is applied. Landscape materials should include native plants or plants compatible with a desert environment. Special care should be given to protect existing vegetation and natural features that can be incorporated into the design.

Handset riprap and decomposed granite are to be the primary inorganic materials. Plant palette shall consist of indigenous and desert-compatible materials. Refer to Section 8-1.100.

E. Natural Character

A goal of the natural streetscape designation is to keep the streetscape compatible with the natural desert. For this reason, the applicant should select plants that are native to the Upper Sonoran Desert and match densities to the existing and adjacent desert environment. The design elements for the Natural Character area are governed in part by the city's Environmentally Sensitive Lands (ESL) Ordinance. Refer to this ordinance for specific requirements on plant and materials selection. Native stone and indigenous decomposed granite are to be the primary inorganic materials.

Plant palette shall consist of indigenous materials only, and shall conform to the native distribution patterns, densities and maturity. Refer to Chapter 10.

F. Blending of Abutting Character Areas

Where two different character areas adjoin, a blending of the two categories should occur to prevent a marked difference between opposing sides of streets. These guidelines apply to all landscaped areas within the public rights-of-way. Areas between the rights-of-way and building setback lines are encouraged to use these guidelines as well. Transitional areas which abut the ESL zoning district (or the Natural Character) should primarily use native to strengthen the tie to the natural desert and to prevent the spread of invasive, non-native species into natural areas.

RECOMMENDED PLANTS

8-1.100

DOWNTOWN AND URBAN CHARACTER

8-1.101

Reference the city's Downtown Urban Design and Architectural Guidelines for Downtown Area recommended plants; other plants will be considered on an individual basis.

SUBURBAN CHARACTER

8-1.102

The following native and desert compatible plants, trees and shrubs are recommended for Suburban Character areas within the city.

Note that the plants contained in these tables are suggested as options for the designer. There are growers in the valley that grow specific plant materials, if the plants listed in the Design Standards & Policies Manual (DSPM) cannot be found then alternative plant materials may be selected. Alternative plant materials are subject to city approval.

TREES

TREES (SUBURBAN CHARACTER)	
BOTANICAL NAME	COMMON NAME
<i>Acacia aneura</i>	Mulga
<i>Acacia berlandieri</i>	Guajillo/Plains Acacia
<i>Acacia farnesiana</i> v. 'Sierra Sweet'	Podless Sweet Acacia
<i>Acacia rigidula</i>	Blackbrush Acacia
<i>Acacia salicina</i>	Willow Acacia/Australian Willow
<i>Acacia stenophylla</i>	Shoestring Acacia

TREES (SUBURBAN CHARACTER)	
BOTANICAL NAME	COMMON NAME
<i>Bauhinia lunarioides</i>	Anacacho/Orchid Tree
<i>Caesalpinia cacalaco</i> 'Smoothie'	Cascalote ("Sierra Sun")
<i>Caesalpinia Mexicana</i>	Mexican Bird of Paradise
<i>Chilopsis lenearis</i>	Desert Willow 'Bubba' 'Arts Seedless' 'Lucretia Hamilton' 'Warren Jones'
<i>Chitalpa tashkentensis</i>	Chitalpa
<i>Cordia boissieri</i>	Texas Olive
<i>Dalbergia sisso</i>	Sisso
<i>Ebenopsis ebano</i>	Texas Ebony
<i>Eucalyptus camaldulensis</i>	Red Gum
<i>Eucalyptus papuana</i>	Ghost Gum
<i>Eucalyptus salmonophloia</i>	Salmon Gum
<i>Eucalyptus salubris</i>	Gimlet
<i>Eucalyptus sargentii</i>	Salt River Mallet
<i>Eucalyptus spathulata</i>	Narrow Leaf Gimlet
<i>Fraxinus velutina</i> v. Fan West	Fan West Ash
<i>Lysiloma thornberi</i>	Desert Fern
<i>Olea</i> 'Swan Hill'™	Olive
<i>Parkinsonia hybrid</i> 'Desert Museum'	Palo Verde
<i>Parkinsonia hybrid</i>	Final species and varieties are subject to approval upon final plan review
<i>Pistacia chinensis</i>	Chinese Pistache v. 'Sarah's Radiance'
<i>Pistacia hybrid</i> 'Red Push'	Red Push Pistache
<i>Prosopis hybrid</i> (thornless)	Final species and varieties are subject to approval upon final plan review
<i>Quercus polymorpha</i>	Monterrey Oak
<i>Quercus buckleyi</i>	Texas Red Oak
<i>Quercus emoryi</i>	Live Oak
<i>Quercus engelmannii</i>	Engelman Oak
<i>Quercus fusiformis</i>	Texas Live Oak
<i>Quercus muhlenbergia</i>	Chestnut Oak
<i>Quercus virginiana</i>	Southern Live Oak
<i>Sophora secundiflora</i>	Texas Mountain Laurel
<i>Tipuana tipu</i>	Tipu Tree
<i>Ulmus parviflora</i>	Chinese Elm v. 'Bosque'

TREES (SUBURBAN CHARACTER)	
BOTANICAL NAME	COMMON NAME
	v. 'Drake'
<i>Vitex agnus-castus</i>	Chaste Tree

SHRUBS

SHRUBS (SUBURBAN CHARACTER)	
BOTANICAL NAME	COMMON NAME
<i>Agave desmettiana</i>	Agave
<i>Agave gemniflora</i>	Twin Flower Agave
<i>Agave parryi v. truncata</i>	Artichoke Agave
<i>Agave vilmoriniana</i>	Octopus Agave
<i>Aloe barbadensis</i>	Aloe Vera/Medicinal Aloe
<i>Aloe X 'Blue Elf'</i>	Aloe
<i>Aloe striata</i>	Coral Aloe
<i>Baileya multiradiata</i>	Desert Marigold
<i>Buddleja marrubifolia</i>	Wooly Butterfly Bush
<i>Caesalpinia gilliesii</i>	Yellow Bird of Paradise
<i>Caesalpinia mexicana</i>	Mexican Bird of Paradise
<i>Caesalpinia pulcherrima</i>	Red Bird of Paradise
<i>Calliandra californica</i>	Red Fairy Duster
<i>Calliandra eriophylla</i>	Pink Fairy Duster
<i>Calliandra hybrid</i>	'Sierra Starr'
<i>Caryopteris clandonensis</i>	Blue-mist
<i>Cordia parvifolia</i>	Little Leaf Cordia
<i>Dalea frutescens var 'Sierra Negra'TM</i>	Black Dalea
<i>Dalea greggii</i>	Trailing Indigo Bush
<i>Dasyliirion texanum</i>	Desert Spoon
<i>Dodonaea viscosa</i>	Hopbush
<i>Euphorbia rigida</i>	Gopher Plant
<i>Euphorbia antisiphilitica</i>	Candelilla
<i>Encelia farinosa</i>	Brittlebush
<i>Eremophila hygrophana</i>	Emu Bush
<i>Eremophila maculate</i>	Valentine Bush
<i>Hamelia patens</i>	Mexican Firecracker
<i>Hesperaloe parviflora, red</i>	Red Yucca
<i>Hesperaloe parviflora, yellow</i>	Yellow Yucca
<i>Hesperaloe parviflora</i>	'Brakelights'
<i>Hesperaloe funifera</i>	Giant Hesperaloe
<i>Hesperaloe nocturna</i>	Night Flowering Hesperaloe
<i>Hyptis emoryi</i>	Desert Lavender
<i>Justicia californica</i>	Chuparosa
<i>Justicia spicigera</i>	Mexican Honeysuckle
<i>Lantana species</i>	Gold, Yellow, Red, Purple Trailing

SHRUBS (SUBURBAN CHARACTER)	
BOTANICAL NAME	COMMON NAME
<i>Leucophyllum candidum</i>	Violet Texas Ranger
<i>Leucophyllum compacta</i>	Texas Ranger Sage
<i>Leucophyllum frutescens</i> 'Green Cloud™'	Texas Ranger Sage
<i>Leucophyllum laevigatum</i>	Chihuahuan Sage
<i>Leucophyllum langmaniae</i>	Lynn's Legacy Sage v. 'Lynn's Legacy'
<i>Leucophyllum pruinatum</i>	Bubblegum Sage
<i>Leucophyllum revolutum</i>	Houdini Sage
<i>Leucophyllum zygophyllum</i>	Cimarron Dwarf Sage
<i>Manfreda maculosa</i>	Texas Tuberose
<i>Oenothera caespitosa</i>	White Evening Primrose
<i>Parthenocissus</i> , variety 'Hacienda Creeper™'	Virginia Creeper
<i>Pedilanthus macrocarpus</i>	Slipper Plant
<i>Penstemon eatonii</i>	Firecracker Penstemon
<i>Penstemon parryi</i>	Parry's Penstemon
<i>Penstemon superbus</i>	Coral Penstemon
<i>Podranea ricasoliana</i>	Pink Trumpet Vine
<i>Portulacaria afra</i>	Elephant Food
<i>Ruellia peninsularis</i>	Desert Ruellia
<i>Russelia equisetiformis</i>	Coral Fountain
<i>Salvia clevelandii</i>	Chaparral Sage
<i>Salvia X 'Trident</i> ™'	Salvia
<i>Simmondsia chinensis</i>	Jojoba
<i>Sphaeralcea ambigua</i>	Globe Mallow
<i>Tecoma stans</i>	Yellow Bells v. 'Orange Jubilee' v. 'Gold Star' v. 'Sun Rise' v. 'Crimson Flare' v. 'Solar Flare' v. 'Sierra Apricot'
<i>Vauquelinia californica</i>	Arizona Rosewood
<i>Verbena gooddingii</i>	Gooding Verbena
<i>Zephyranthes species</i>	Rain Lily
<i>Zinnia grandiflora</i>	Prairie Zinnia

TRANSITIONAL ARID CHARACTER

The following native and desert compatible plants, trees and shrubs are recommended for Transitional Arid Character areas within the city.

8-1.103

TREES

TREES (TRANSITIONAL ARID CHARACTER)	
BOTANICAL NAME	COMMON NAME
<i>Acacia aneura</i>	Mulga
<i>Acacia berlandieri</i>	Guajillo/Plains Acacia
<i>Acacia farnesiana</i> v. 'Sierra Sweet'	Podless Sweet Acacia
<i>Acacia rigidula</i>	Blackbrush Acacia
<i>Acacia salicina</i>	Willow Acacia/Australian Willow
<i>Acacia schaffneri</i>	Twisted Acacia
<i>Acacia willardiana</i>	Palo Blanco
<i>Acacia stenophylla</i>	Shoestring Acacia
<i>Caesalpinia cacalaco</i> 'Smoothie™'	Cascalote
<i>Caesalpinia mexicana</i>	Mexican Bird of Paradise
<i>Chilopsis lenearis</i>	Desert Willow 'Bubba' 'Arts Seedless' 'Lucretia Hamilton' 'Warren Jones'
<i>Cordia boissieri</i>	Texas Olive
<i>Ebenopsis ebano</i>	Texas Ebony
<i>Ebenopsis mexicana</i>	Texas Ebony
<i>Eysenhardtia orthocarpa</i>	Kidneywood
<i>Fouquieria macdougalii</i>	Mexican Tree Ocotillo
<i>Fouquieria splendens</i>	Ocotillo
<i>Havardia pallens</i>	Tenaza
<i>Lysiloma thornberi</i>	Desert Fern
<i>Olneya tesota</i>	Ironwood
<i>Parkinsonia hybrid</i>	Final species and varieties are subject to approval upon final plan review
<i>Prosopis hybrid (thornless)</i>	Final species and varieties are subject to approval upon final plan review

SHRUBS

SHRUBS (TRANSITIONAL ARID CHARACTER)	
BOTANICAL NAME	COMMON NAME
<i>Acacia cultriformis</i>	Knife Acacia
<i>Agave spp.</i>	Final species and varieties are subject to approval upon final plan review
<i>Ambrosia ambrosioides</i>	Giant Bursage
<i>Ambrosia deltoidea</i>	Triangle Leaf Bursage
<i>Ambrosia dumosa</i>	White Bursage
<i>Asclepias subulata</i>	Desert Milkweed
<i>Baileya multiradiata</i>	Desert Marigold

SHRUBS (TRANSITIONAL ARID CHARACTER)	
BOTANICAL NAME	COMMON NAME
<i>Buddleja marrubifolia</i>	Woolly Butterfly Bush
<i>Caesalpinia mexicana</i>	Mexican Bird of Paradise
<i>Caesalpinia pulcherrima</i>	Red Bird of Paradise
<i>Calliandra californica</i>	Red Fairy Duster
<i>Calliandra eriophylla</i>	Pink Fairy Duster
<i>Calliandra hybrid</i>	'Sierra Starr'
<i>Celtis pallida</i>	Desert Hackberry
<i>Chrysactinia mexicana</i>	Damianita
<i>Cordia parvifolia</i>	Little Leaf Cordia
<i>Dalea capitata</i>	Lemon Dalea
<i>Dalea greggi</i>	Trailing Indigo Bush
<i>Dasylyrion texanum</i>	Desert Spoon
<i>Encelia farinose</i>	Brittle Brush Bush
<i>Ericameria laricifolia</i>	Turpentine Bush
<i>Eriogonum fasciculatum</i>	Flattop Buckwheat
<i>Fouquieria macedougalii</i>	Mexican Tree Ocotillo
<i>Fouquieria splendens</i>	Ocotillo
<i>Guaiacum coulteri</i>	Guayacan
<i>Hesperaloe parviflora, red</i>	Red Yucca
<i>Hesperaloe parviflora, yellow</i>	Yellow Yucca
<i>Hesperaloe parviflora</i>	'Brakelights'
<i>Hesperaloe funifera</i>	Giant Hesperaloe
<i>Hesperaloe nocturna</i>	Night Flowering Hesperaloe
<i>Hyptis emoryi</i>	Desert Lavender
<i>Justicia californica</i>	Chuparosa
<i>Justicia spicigera</i>	Mexican Honeysuckle
<i>Larrea tridentata</i>	Creosote Bush
<i>Leucophyllum candidum</i>	Violet Texas Ranger
<i>Leucophyllum compacta</i>	Texas Ranger Sage
<i>Leucophyllum frutescens 'Green Cloud™'</i>	Texas Ranger Sage
<i>Leucophyllum laevigatum</i>	Chihuahuan Sage
<i>Leucophyllum langmaniae</i>	Lynn's Legacy Sage v. 'Lynn's Legacy'
<i>Leucophyllum pruinose</i>	Bubblegum Sage
<i>Leucophyllum revolutum</i>	Houdini Sage
<i>Leucophyllum zygophyllum</i>	Cimaron Dwarf Sage
<i>Lycium andersonii</i>	Desert Wolfberry
<i>Malpighia emarginata</i>	Barbados Cherry
<i>Nolina nelsonii</i>	Blue Beargrass Tree
<i>Nolina microcarpa</i>	Beargrass
<i>Nolina texana</i>	Beargrass
<i>Nolina matapensis</i>	Sonoran Tree Beargrass

SHRUBS (TRANSITIONAL ARID CHARACTER)	
BOTANICAL NAME	COMMON NAME
<i>Oenothera caespitosa</i>	White Evening Primrose
<i>Opuntia spp.</i>	Final species and varieties are subject to approval upon final plan review
<i>Penstemon eatonii</i>	Firecracker Penstemon
<i>Penstemon parryi</i>	Parry's Penstemon
<i>Penstemon superbus</i>	Coral Penstemon
<i>Podranea ricasoliana</i>	Pink Trumpet Vine
<i>Russelia equisetiformis</i>	Coral Fountain
<i>Salvia clevelandii</i>	Chaparral Sage
<i>Salvia X 'Trident'™</i>	Salvia
<i>Simmondsia chinensis</i>	Jojoba
<i>Sphaeralcea ambigua</i>	Globe Mallow v. 'Louis Hamilton
<i>Vauquelinia californica</i>	Arizona Rosewood
<i>Viguiera parishii</i>	Goldeneye
<i>Yucca baccata</i>	Banana Yucca
<i>Yucca elata</i>	Soaptree Yucca
<i>Yucca carnerosana</i>	Spanish Dagger
<i>Yucca pallida</i>	Pale Leaf Yucca
<i>Yucca rupicola</i>	Twisted Leaf Yucca
<i>Zinnia grandiflora</i>	Prarie Zinnia

LANDSCAPE GUIDELINES

8-1.200

All streetscape designs and infrastructure must meet the following minimum requirements based upon the city's ordinances. Refer to City of Scottsdale (COS) Supplement to Maricopa Association of Governments (MAG) Section 430 and related details.

MAINTENANCE RESPONSIBILITY

8-1.201

The purpose of these maintenance requirements is to keep city rights-of-way attractive, sustainable, safe, and clear for their designated and normal transportation uses.

- A. Property owner's responsibility to maintain the adjacent right-of-way from the back of the curb remains as set forth in the city code.
- B. Maintenance of newly constructed and/or modified landscaped medians ways will be the responsibility of the developer, property owner, or a homeowners' association through a two year grow-in period to commence after the successful completion of a final inspection. For a Capital Improvement Project this period will be for 90 days after final inspection. This final inspection shall be conducted by a representative of Inspection Services and Capital Projects, if a capital project, or a representative of Inspection Services and Parks Department, if a development

project. Maintenance must be conducted under the proper permits. Refer to Section 5-2.000, Rights-of-Way Management.

Maintenance responsibility includes:

- A. Pruning and maintaining all plants, shrubs, bushes, trees and ground cover to (i) keep all plants behind sidewalks and curbs, and (ii) prevent sign obstructions and sight distance hazards. Pruning shall be done in conformance with the standards of American National Standards Institute (ANSI) A300 and Arizona Certified Landscape Professionals.
- B. Weeding by hand or with herbicides labeled "Caution" only. Herbicide application shall be performed by a certified applicator registered with the Arizona Department of Agriculture.
- C. Removing dead plants and replacing them with low water use plants of a similar size and type. The replacement plants shall be selected from the Arizona Department of Water Resources (ADWR) list of low water use plants.
- D. Removing litter and debris, which includes, without limitation, fallen leaves, trimmings, wind-blown material, trash, cigarette butts, downed or broken tree limbs, and small dead animals (i.e., under 25 pounds).
- E. Sweeping.
- F. Removing all landscape maintenance equipment.

MEDIAN WIDTHS

8-1.202

- A. Median width is measured from back of median curb to back of median curb (inside to inside).
- B. The minimum width for a landscaped median is 4 feet. Within the city's Hillside Area, 8 feet is the minimum requirement.

Medians less than 4 feet in width will either be Portland cement concrete, stamped concrete, exposed aggregate concrete or concrete pavers; no plant material will be allowed.

PLACEMENT OF TREES AND SHRUBS

8-1.203

For landscape and planting details of trees, cacti, shrubs and groundcovers, refer to COS Supplement Details Nos. 2620 - 2623.

Trees should be located so that the expected mature tree canopy does not ultimately extend into the street rights-of-way as shown in Figure 8-1.2 and Figure 8-1.3.

Consider the mature tree height and placement of trees to minimize potentially adverse effects on above-ground utilities or signage. Select a tree genus or species with rapid vertical growth, columnar shape, or which develops a canopy rapidly when planting trees less than 10 feet from back of curb. Tree density must be no less than 25 feet on center along pedestrian corridors.

Trees should not be planted within 15 feet of an existing private wall, sign or light pole. Separation distances between walls and trees for infill projects will be determined by staff on a case-by-case basis.

Planting distance between trees shall be no less than the mature canopy width.

Shrubs shall be planted no less than 5 feet from tree trunks to prevent overwatering.

Natural growth habits shall be taken into consideration to minimize maintenance frequency and intensity.

Shrub spacing shall be no less than mature size.

Shrubs and groundcovers shall be planted no less than 2 feet from sidewalks, curbs, or paths.

Landscaping clearance shall be provided to prevent conflict with signs, lighting, sidewalks/paths, fire equipment or median crossings.

Landscaping must not create hazards to public safety through plant growth habit, structure, or location.

There shall be a physical separation (concrete curbing) provided between public and private landscaping/irrigation systems.

For Saguaro relocation procedures, refer to Section 10-1.200.

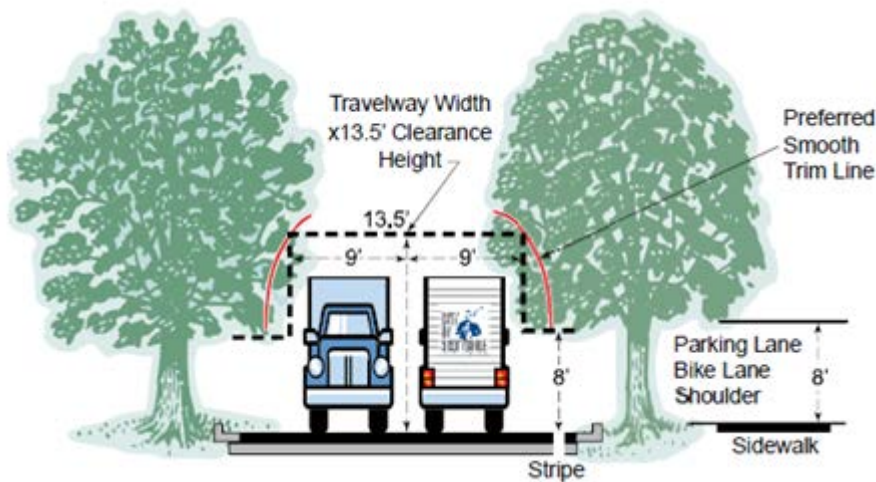

FIGURE 8-1.2 RESIDENTIAL ROADWAY CLEARANCES (30 MILES PER HOUR (MPH) OR LESS)

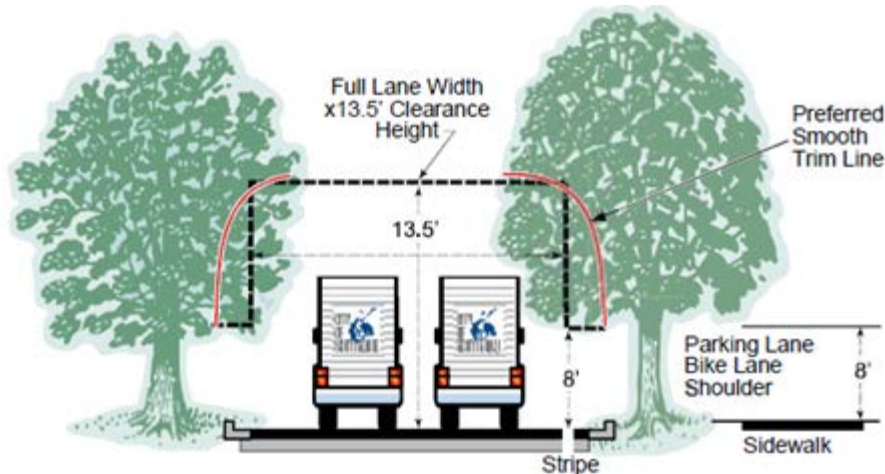

FIGURE 8-1.3 ARTERIAL OR COLLECTOR ROADWAY CLEARANCES (35 MILES PER HOUR (MPH) OR GREATER) LANDSCAPED MEDIANS/ROWS

TREES QUANTITIES AND SIZES

8-1.204

Trees should be provided at the rate of 1 tree per each 35 linear feet of median length. The minimum size is 15 gallons with 50 percent to be provided as mature trees or larger (as defined in Article III of the Zoning Ordinance). Salvaged trees must meet ANSI A300 (Part 1) Pruning Standards and ANSI A300 (Part 6) Transplanting Standards with a minimum of 2 ½ inch trunk caliper.

GRADING

8-1.205

- A. Mounding may be appropriate as determined by staff. Mounding should not be used in the areas designated as Downtown and Urban Character zones. Care should be taken when designing landscaping within the sight distance triangles. Mounds within sight distance easements must not exceed a height of 18 inches as measured above the final grade elevation. All mounding should blend with the adjacent existing terrain.
- B. The maximum slope of any mounding shall be 1:4 (25%).
- C. The finished landscape grade with decomposed granite should be smooth, uniform, and a minimum of 2 inches below the top of curb.

DECOMPOSED GRANITE

8-1.206

- A. Size must be ½ inch screened Desert Gold or of a matching color to that of adjacent landscaped areas. The decomposed granite color must match native earth tones.
- B. For installation and details for public works construction, refer to COS Standard Detail No. 2620-1.
- C. A sample will be submitted to a representative from Parks Department for approval prior to the contractor ordering and bringing it onto the site. Color shall match what exists in the area.
- D. Decomposed granite will be distributed uniformly to a depth of 2 inches covering the entire landscape area.

BOULDERS

8-1.207

Boulders are not acceptable for city landscaped medians and rights-of-way, unless otherwise approved by Risk Management. Call 480-312-5082 for more information.

PLANT SELECTION

8-1.208

All plant materials used in a median are required to come from the ADWR low water use plant list for the Phoenix Active Management Area. The selected plant materials are also to be consistent with the appropriate character areas described in Section 8-1.100.

Public rights-of-way that are in the ESL zoning district's Upper Desert and Hillside landforms must be landscaped with plants from the City of Scottsdale's Indigenous Plants for Environmentally Sensitive Lands list. This list is available in the city's One Stop Shop. Refer to DSPM Chapter 10, Scottsdale Landscape Ordinance and the ESL zoning district for additional specific plant selection requirements.

The selection of agave should include plants of varied age to improve the sustainability of the landscape by reducing the potential for plant expiring at the same time/year.

HYDROSEEDING AND NATURAL AREA OPEN SPACE (NAOS) RESTORATION

8-1.209

Seed mix shall be composed of native species as defined in the Environmentally Sensitive Lands Ordinance.

IRRIGATION GUIDELINES

8-1.300

See the city's most current supplement to MAG Section 440 and related details for more specific information.

A. Approved Irrigation System Types

Centralized control or solar powered.

B. Controllers

Place controllers in the center of the median, a minimum of 50 feet before the beginning of the turn bay.

Approved controllers are either centralized in type or Leit/DIG X series solar.

Contact the city's Irrigation Department for specific centralized controller type.

C. Power Source

The contractor is responsible for initiating account and service connection.

If the power source cannot be placed within the median or the rights-of-way, a utility easement must be provided. This location is to be indicated and noted on the final irrigation plans and inside of the controller cabinet.

D. Water Source

Show both the water source and location of the proposed tap on the final irrigation plans.

Contact Water Resources at 480-312-5650 for information on tapping into city waterlines.

Plans must indicate existing and design operating water pressure requirements.

The water meter should be located within a median wherever possible.

E. Remote Control Electric Valves

Valves are to be of brass construction, and a minimum size of 1 inch.

An approved valve is Hunter IBV

Full Port brass ball valves must be installed immediately upstream of all control valves.

All direct buried control valve wiring shall be a minimum 14 gauge.

Master valves are to be installed on all irrigation mainlines. Contact the city's Irrigation Department for specific master valve type.

F. Backflow Prevention Devices

Only reduced pressure assemblies will be used.

Irrigation backflow preventers are to be installed inside an approved lockable enclosure.

A certified tester, recognized by the city, must test backflow prevention devices before the city will accept responsibility for maintaining the system.

GENERAL IRRIGATION DESIGN CRITERIA

8-1.301

- A. The irrigation system is to be located entirely within the median. Sleeving from median-to- median is acceptable.
- B. The contractor is responsible for initiating the account and having the water meter set.
- C. Trees, shrubs, and cacti shall be valved separately.
- D. The median irrigation system must have separate power and water meters from other irrigation systems.
- E. Plans must indicate valve flow rates, size, designation (tree, shrubs and cactus) and station number.

FINAL PLAN SUBMITTALS

8-1.302

Final submittal for irrigation and landscape plans must show related details.

SIGHT DISTANCE

8-1.400

Any plant material installed in a questionable area (such as safety triangles, sight lines) will be identified by traffic engineering and removed by the contractor. Sight distance must be considered for vehicles entering and exiting adjacent properties, as well as for vehicles using abutting roadways.

A. Sight Distances and Safety Triangle

To determine sight distances, use the criteria specified in Section 5-3.

The sight line, as shown in Figure 5-3.25 and Figure 5-3.26, shall be clearly indicated and delineated on the final landscape plan submittal.

B. Planting within the Sight Triangle

Shrubs planted within the sight triangle are to have a mature height of not more than 3 feet. Height will be from edge of pavement, and total height will include the height of any mounding.

Trees planted within the safety triangle are to have a canopy pruned to a height of 8 feet or greater upon installation. Height will be from edge of pavement, and total height will include the height of any mounding.

ALTERATIONS AND AS-BUILTS

8-1.500

If field conditions require relocating a water meter, backflow prevention device, controller, valve, or any other major component of the irrigation system as shown on approved plans, contact Inspection Services at 480-312-5750 or Capital Projects Management at 480-312-7250 prior to any installation.

The contractor must provide an accurate set of as-built Mylar drawings and Computer Aided Drafting/Design (CAD) format per Section 5-2.400 of this manual to the Parks Department representative prior to the final acceptance of a system.

SPECIFIC AREA DESIGN GUIDELINES

8-1.600

In circumstances where a special theme is desired, the city may designate specific design standards to be implemented on select streets. Contact the One Stop Shop at 480-312-2500 for more information.

SCOTTSDALE GATEWAYS

8-1.700

Scottsdale shares common boundaries with several municipalities. When entering Scottsdale from a neighboring community, it is helpful for residents and visitors to have a sense of arrival into the city. By a city limits identification system, those entering the city should be able to readily recognize their entrance into Scottsdale. The Gateways Map shows the locations of city entrance points. Refer to the city's General Plan Environmental Design Element.

MEDIAN INSPECTIONS

8-1.800

- A. City staff will arrange a pre-construction meeting with the contractor to review approved plans, MAG requirements, testing, maintenance responsibility, etc.
- B. City staff will inspect the following items before and during construction for compliance with city-approved plans and city addendums to MAG:
 - Water meter and backflow preventer and master valve location
 - Controller type and location
 - Remote control valve type, location and operation
 - Source of power (inside enclosure)
 - Type of pipe and trench depth
 - Laterals and trench depth
 - Emitters and flush pits
 - Sleeves under asphalt
 - Pressure check system
 - Backflow preventer and enclosure (Notify city Cross Connection Control for inspection and testing)
 - Plant palette and location

Planting depth

Tree staking

Sight distance triangles

Pre-emergent

Decomposed granite

- C. City Irrigation Department staff will perform a final inspection with the contractor after completion of work for approval to begin warranty period.
- D. Upon city staff approval, city staff will issue a Maintenance Period Notification letter to permittee (encroachment permit) to start warranty period.
- E. City Irrigation Department staff will perform a warranty inspection with the permittee at the end of the warranty period.
- F. Upon city staff approval, city staff will issue the Final Letter of Acceptance to permittee to end the warranty period and begin city maintenance of median.

Section 8-2

PARKS

8-2

This section provides guidance for developing park master plans, identifies their review and approval process, and provides requirements for park designs. The design review of each park is done on an individual basis. These design standards and policies help assure that Scottsdale's parks and recreation facilities provide quality and safe experiences for its citizens.

GENERAL INFORMATION

8-2.000

A. **Neighborhood Parks**

Neighborhood Parks provide primary park services and facilities, which are easily accessible and available to local residents. They are typically between 7 and 20 acres in size, not intended for large group use, and serve residents from 1 block away up to an entire neighborhood. Neighborhood parks are preferably located adjacent to elementary schools or neighborhood centers.

B. **Community Parks**

Community Parks provide a full range of centralized recreational activities for major portions of the city with capabilities of accommodating large group reservations. Generally, these parks feature a community center building designed to meet multi-generational recreation needs. They are typically between 20 and 80 acres in size, serving several neighborhoods or approximately 10,000 to 25,000 people. Community parks are preferably located in the center of several neighborhoods, adjacent to a middle school or high school where possible.

C. **Specialty and Regional Parks**

Specialty and Regional Parks provide specialized facilities and preserve significant unique features of the community, including environmentally sensitive areas. The size of these parks will vary as will the specific number of people served by these parks; however, the parks should be oriented to serve the entire community and beyond. Park locations will also vary depending on the dynamics of the park, such as park theme or mountain park.

PARK LOCATIONS

8-2.001

A. **The General Plan**

The Public Facility Element of the General Plan for Scottsdale provides the basis for identifying locations for the parks. A copy of the Public Facility Element is available at the One Stop Shop.

B. **Community Services Facilities Master Plan**

The Community Services Facilities Master Plan assists in defining park policy, delineates future park needs by acreage and facilities, and locates parks based on demographics. The Master Plan specifies standards to guide park development in Scottsdale. A copy of the Community Services Division Facilities Master Plan can be obtained on the city internet site.

PARK MASTER PLANS

8-2.100

A master plan is developed for each park and the Public Facility Element of the General Plan, in conjunction with the Community Services Facilities Master Plan, helps guide the planning of facilities for each park.

MUNICIPAL USE MASTER PLAN APPROVAL PROCESS

8-2.101

Refer to the city's zoning ordinance for Municipal Use Master Site Plan requirements and approval process.

PARK DESIGN

8-2.200

Whenever possible, parks should be located adjacent to school sites to create a fluid joint use between the park and school facilities.

WALKWAYS

8-2.201

- A. Designated multiuse paths will be a minimum of 12 feet in width. Refer to Section 5-7.000 and Section 5-8.000 for shared-use paths and bikeways.
- B. Sidewalks utilized specifically for pedestrians will be a minimum of 8 feet in width.
- C. All multiuse paths will be located a safe distance away from active courts or fields.
- D. Where concrete is used, it will be MAG "A" spec, 5-inch slump 3,000 pounds per square inch (psi), 6-inch-deep or 4-inch-deep with 6-inch turndowns. Curb ramps will be constructed in accordance with MAG Details.
- E. Where concrete or asphalt is not used, walkways will be surfaced with stabilized decomposed granite.
- F. Sidewalk slopes and cross slopes will comply with Americans with Disabilities Act (ADA) standards, unless technically infeasible.
- G. All walkways leading to, into, and throughout sporting areas will be ADA compliant unless to do so would fundamentally alter the nature of the facility/activity.

DRINKING FOUNTAINS

8-2.202

- A. Ensure drinking fountains meet ADA guidelines by having a wheelchair accessible fountain installed at 34 inches Above Finished Floor (AFF) and a standard height drinking fountain installed at 40 inches AFF. Do not construct drinking fountains with ferrous metals whether protected by galvanization, paint, or otherwise. Drinking fountains within 100 feet of playgrounds will have accessible sand traps installed on the drains. It is more desirable to install drinking fountains on a building than installing free-standing units. Locate chillers within 24 inches of the drinking fountains, and no recirculating pumps are allowed. Use copper water piping for the drinking fountains and insulate chilled water tubing.
- B. Install chilled drinking fountain(s) near the playground, but preferably not closer than 25 feet due to problems encountered with sand. In addition to the above, install a child-height drinking fountain at 28 inches AFF.

PLAYGROUNDS

8-2.203

- A. Playgrounds must meet or exceed all current U.S. Consumer Products Safety Commission (CPSC), American Society of Test/Measurement, ADA, and International Play Equipment Manufacturers Association (IPEMA) standards.
- B. Upon completion/installation of new playground equipment, the installation will be inspected by a third party National Playground Safety Inspector (NPSI).
- C. Ensure that playground equipment/play opportunities are available for preschool children (2 - 5 years old) and school-age children (5 - 12 years old).
- D. Metal playground slides are unacceptable.
- E. Install and/or use appropriate playground elements, equipment and materials to meet ADA access standards for accessible playgrounds.

- F. Ensure that playground surface safety zones consist of double washed premium sand, with a minimum depth of 12 inches.
- G. Ensure that there is some type of shade protection either from adjacent ramadas (16 feet x 16 feet minimum) and/or non-deciduous trees on the perimeter of the playground (30-inch box).

SOFTBALL / BASEBALL FIELDS

8-2.204

- A. Ensure that all fields are lighted to meet DSPM 8-2.205.
- B. Construct infields with an approved non-toxic organic binder, red color mix material especially prepared for ball fields. Material will be a minimum of 4 inches in compacted depth. Bind by crushed aggregate screenings down to 1/4 inch or 3/8-inch fine particles.
- C. Fill home plate and mounds with a minimum of 2 inches of fine grey brick clay incorporated at a uniform rate with established infield red mix. Infields and outfield turf areas will consist of a Hybrid Bermuda Grass.
- D. When grading playing fields, adhere to Sports Fields Manual for Design and Construction standards and requirements for design and construction.
- E. Finish grade for sports fields must be no greater than 1% in slope.
- F. Outfield warning tracks are not to be included in ball field designs.

SPORTSFIELD LIGHTING

8-2.205

A. **Lighting shall be the following:**

Energy efficient and cost effective to operate.

Proactively monitored to detect fixture outages.

Installed with remote on/off controls.

Designed such that the light levels and the entire system are guaranteed for a period of 25 years.

Designed so playing surfaces will have guaranteed average constant light level and uniformity as follows:

AREA OF LIGHTING	AVERAGE CONSTANT LIGHT LEVELS	MAX. TO MIN. UNIFORMITY RATIO
<i>Infield</i>	50 foot-candles	2.0 to 1.0
<i>Outfield</i>	30 foot-candles	2.5 to 1.0
<i>Soccer/Football</i>	30 foot-candles	2.5 to 1.0

Life cycle costs for the lighting system shall be calculated and include luminaires' energy consumption, cost of maintenance, spot re-lamping, group re-lamping all luminaires, and total 25-year life cycle operating cost.

Lighting system will not produce excessive spill-light or glare. Maximum vertical foot-candles for each field shall be determined per project with the primary goal to have levels as low as possible so as not to negatively impact neighbors with excessive spill-light or glare. No luminaires will be aimed less than 25 degrees below horizontal. All luminaires will have both internal and external shielding for glare and spill light control.

All poles will include a factory-installed mounting bracket for security lights 20 feet up the pole and infield poles will have a factory-provided electrical outlet enclosure mounted on the lower portions of the pole. Pole heights will vary depending on field size and location. Poles in general will be between 60 feet to 80 feet. General pole locations are as follows for different fields.

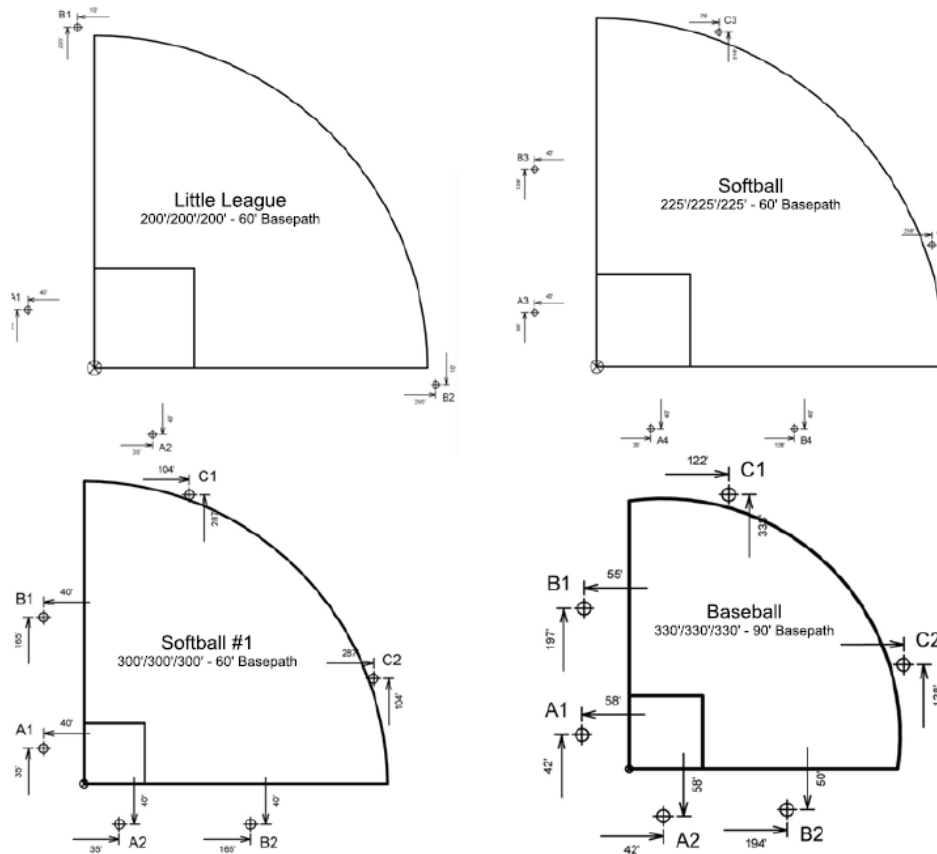

FIGURE 8-2.1 LITTLE LEAGUE, SOFTBALL, AND BASEBALL POLE LOCATIONS

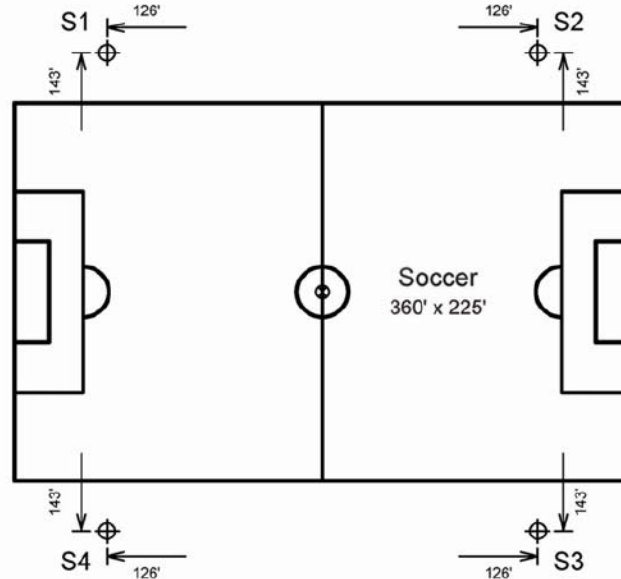

FIGURE 8-2.2 SOCCER POLE LOCATIONS

B. Lighting system shall consist of the following:

Galvanized steel poles and cross arm assembly

Pre-stressed concrete base embedded in concrete backfill.

Luminaires constructed with a die-cast aluminum housing to protect the luminaire reflector system.

All ballasts and supporting electrical equipment in aluminum enclosures mounted approximately 10 feet above grade. The enclosures shall include ballast, capacitor and fusing for each luminaire. Safety disconnect per circuit for each pole structure will be in the enclosure.

Wire harness complete with an abrasion protection sleeve, strain relief and plug-in connections.

Controls and Monitoring Cabinet to provide on-off control and monitoring of the lighting system constructed of NEMA Type 4 aluminum. Communication method shall be provided by manufacturer. Cabinet shall contain custom configured contactor modules for 30, 60, and 100 amperage (Amps), labeled to match field diagrams and electrical design. Manual Off-On-Auto selector switches shall be provided.

C. Requirements for lighting system

All components shall be designed and manufactured as a system. All luminaires, wire harnesses, ballast and other enclosures shall be factory assembled, aimed, wired and tested.

All exposed components shall be constructed of corrosion resistant material and/or coated to help prevent corrosion. All exposed steel shall be hot dip galvanized per American Society for Testing Materials (ASTM) A123. All exposed hardware and fasteners shall be stainless steel of at least 18-8 grade, passivated and polymer coated to prevent possible galvanic corrosion to adjoining metals. All

exposed aluminum shall be powder coated with high performance polyester. All exterior reflective inserts shall be anodized, coated with a clear, high gloss, durable fluorocarbon, and protected from direct environmental exposure to prevent reflective degradation or corrosion. All wiring shall be enclosed within the cross arms, pole, or electrical components enclosure.

Lightning Protection: All structures shall be equipped with lightning protection meeting National Fire Protection Association (NFPA) 780 standards and be properly grounded.

All system components shall be UL Listed for the appropriate application.

COURT FACILITIES

8-2.206

- A. Make sure that all court facilities are lighted to meet all current Illuminating Engineering Society (IES) standards. Tennis court lighting should also meet United States Tennis Association (USTA) standards.
- B. Ensure that all tennis courts meet all other USTA standards. Concrete courts should be considered for installation due to extended life in a desert environment.
- C. Sand Volleyball courts should consist of Double Washed Mortar Sand Premium Grade at a depth of 12 inches.
- D. For wetting courts, provide water in the net standards with a Hunter series head in each standard. Also, use domestic water as a source instead of water from the irrigation system. Make sure that all water piping is type L copper. Control the water with a system timer that allows for watering times up to 15 minutes and locks out the controls for a minimum of 30 minutes between activations. Activation will be by a 24-volt momentary contact switch mounted on a net standard or other pole.

IRRIGATION GUIDELINES

8-2.207

Refer to the city's current supplement to MAG Section 440 and related details for more specific information.

- A. Irrigation backflow preventers to be installed inside an approved lockable enclosure.
- B. Only reduced pressure backflow preventer assemblies are to be used.
- C. Only centralized irrigation system controllers are to be used. Contact City Irrigation Department for specific type.
- D. On controller cabinets install pushbuttons to activate ball field dust control valves.
- E. Ball fields to have irrigation installed for dust control.
- F. Master valve/flow meters (Hydrometers) to be installed on all irrigation mainlines.
- G. Drip irrigation systems shall be installed using rigid polyvinyl chloride piping (PVC).
- H. Valves are to be of brass construction and a minimum size of 1 inch.
- I. Trees, shrubs and cacti are to be valved separately.
- J. Plans must indicate existing and design operating water pressure requirements.
- K. Plans must indicate valve size, flow rates, designation (tree, shrub, turf, cactus etc.) and station number.
- L. Plans must include city details for all irrigation system components to be installed.
- M. Drip irrigation to be installed for all trees in turf areas for supplemental watering.

- N. Minimum water coverage for turf/spray areas shall be head to head coverage. Other planting areas shall receive 100% emitter coverage.
- O. Top, bottom and middle of sloped turf areas 1:4 or greater shall be irrigated/valved separately.
- P. Drip irrigation for trees in turf areas shall be irrigated on a separate valve from trees in decomposed granite areas.
- Q. For a suggested Baseball Field Irrigation Design refer to Appendix 8-2A.
- R. For a suggested Softball Field Irrigation Design refer to Appendix 8-2B.
- S. For a suggested Soccer Field Irrigation Design refer to Appendix 8-2C.
- T. For a suggested Little League Field Irrigation Design refer to Appendix 8-2D.

LANDSCAPING

8-2.208

For landscaping, use low-water use, drought-tolerant species that adhere to ADWR plant list. Plant material must be approved by Parks Department staff prior to installation. Refer to the city's most current [supplement to MAG](#), Section 430, and related [details](#) for more specific information. Refer to Sections 8-1.102 and 8-1.103 for suggested plant material to be used in parks per character area (Suburban and Transitional).

- A. Tree type to conform to the character area in which the park is located.
- B. Decomposed granite is to be ½ inch screened Desert Gold unless otherwise approved by city.
- C. Trees shall not be planted within 15 feet of an existing private wall, sign, or light pole.
- D. Landscape plans must provide COS planting details.
- E. Site distance standards shall be used for park entries. Refer to Section 5-3, and 8-1.400, and the following figure.

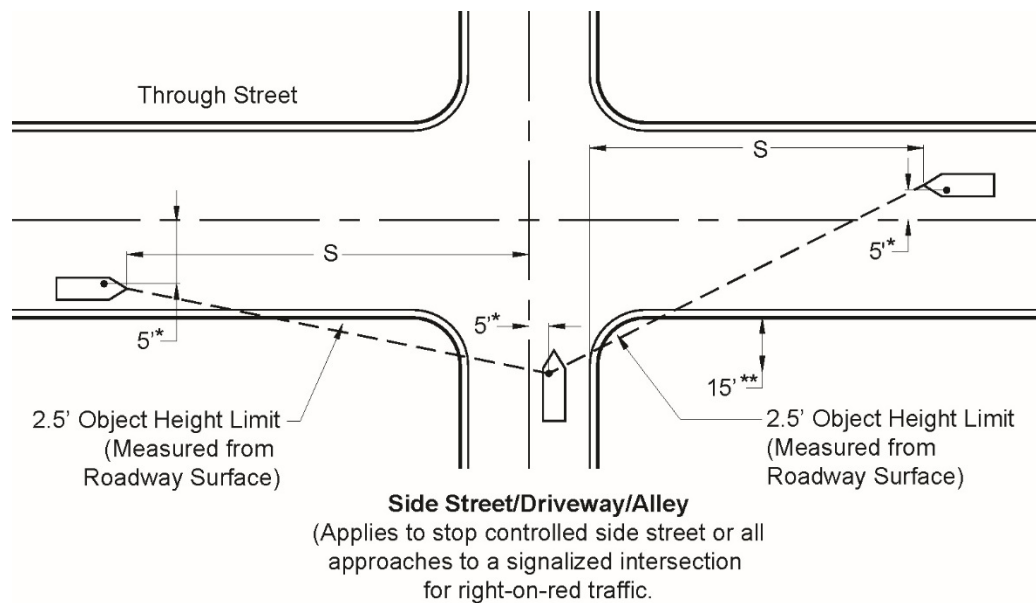

* 5 feet measured to nearest lane line or centerline.

** 15 feet measured from face-of-curb or edge-of-travel way.

S = Intersection sight distance in feet on drivers left and right for right turns, left turns and through traffic. (See AASHTO Geometric Design of Highways and Streets (current version) for additional sight distance requirements.)

(See Appendix 5-3A, Appendix 5-3B and Appendix 5-3C for distance S.)

FIGURE 8-2.3 INTERSECTION DEPARTURE SIGHT DISTANCE REQUIREMENTS

- F. Natural growth habits shall be taken into consideration to minimize maintenance frequency and intensity.
- G. Planting distance between trees shall be no less than the mature canopy width.
- H. Shrubs shall be planted no less than 5 feet from tree trunks to prevent overwatering.
- I. Shrub spacing shall be no less than size at maturity.
- J. Shrubs and ground covers shall be planted no less than 2 feet from sidewalks or paths.
- K. Salvaged trees must meet ANSI A300 (Part 1) pruning standards and ANSI A300 (Part 6) transplanting standards with a minimum 2-1/2 inch trunk caliper.
- L. For Saguaro relocation procedures, refer to Section 10-1.200.
- M. Landscape clearances shall be provided to prevent conflict with signs, light poles, fire hydrants, sidewalks/paths or median crossings.
- N. Landscaping must not create hazards to public safety through plant growth habit, structure or location.
- O. Skateboard protection shall be provided on all seat wall caps and benches.
- P. There shall be a physical separation (concrete curbing) provided between public and private landscaping/irrigation systems.

CONSTRUCTION MATERIAL

8-2.209

- A. Use steel, metal, aluminum, recycled material or approved equal for park fixtures and ramadas. Wood will not be permitted. Roofing material needs to be 20-year guaranteed metal, standing seam with Kynar finish.
- B. Between turf and landscaped areas install concrete headers.
- C. Windscreen material to be double leno polypropylene, 85% shade open mesh. Color is to be dark green.
- D. Wabash Manufacturing trash receptacles, or approved equal, are to be installed.

SIGNAGE

8-2.210

- A. Place the standard park sign at the main entrance of every neighborhood and community park. The park sign mold can be obtained from the Parks Department.
- B. Specialty parks may deviate from standard park signage with the approval from the Parks Department. A marquee that meets the city's Sign Ordinance may be acceptable upon the approval of the Parks Department and obtaining a city sign permit.
- C. Certify that all signage meets the city's Sign Ordinance, and ADA signage specifications. Ordinance information can be obtained at the One Stop Shop and [SRC](#).

PARKING

8-2.211

- A. Ensure that all parking meets ADA Guidelines and the city's parking requirements stipulated in the Parks Master Plan and city zoning requirements. Preferred parking spaces utilize Universal Parking dimension specified in Design Standards and Policy Manual Chapter 12.
- B. Ensure that parking lots lights meet all current IES standards.
- C. Plant non-deciduous trees (24-inch boxes minimum) adjacent to parking lots to provide shading. An acceptable ratio is 1 tree per every 15 parking spaces.

PUBLIC POOLS

8-2.212

All public pool facilities must meet or exceed Maricopa County Environmental Health Code Chapter VI. Section 1 General Provisions Regulation 1 - 15 for Pool and Facility Design, Chapter VI. Section 6 Public Swimming Pools, and all State of Arizona and city codes and regulations. All pool main drains must comply with the Virginia Graeme Baker (VGB) Pool and Spa Safety Act and ANSI/ASME A112.19.8-2007.

Refer to current City Aquatic Maintenance Supplement for specific details.

Supplement may be obtained from the city's Aquatic Maintenance Supervisor (480-312-4005).

- A. Mechanical Room Controller Device (MRCD) to be by the BECKS Manufacture Model SYSTEM 7.
- B. Commercial High Rate Sand Filters: EKO 3 Manufactured by NEMATO with an integrated automatic backwash control system.
- C. Chlorine Gas CL2 Equipment by Capital Controls.
- D. Emergency Vapor Scrubber Systems (EVSS) by Siemens Water Technologies.

DECORATIVE FOUNTAINS / WATER FEATURES

8-2.213

The city will not incorporate any additional Decorative Fountains or Water Features into its future projects in the interest of water conservation and safety concerns. However, if a fountain/water feature is approved for a project, City of Scottsdale Aquatic Maintenance will provide a set of mechanical guidelines to the designer. Refer to current City of Scottsdale Aquatic Maintenance Fountain/Water Feature Supplement for specific details. Supplement may be obtained from COS Aquatic Maintenance Coordinator (480-312-4005).

SOFTBALL FIELD IRRIGATION DESIGN

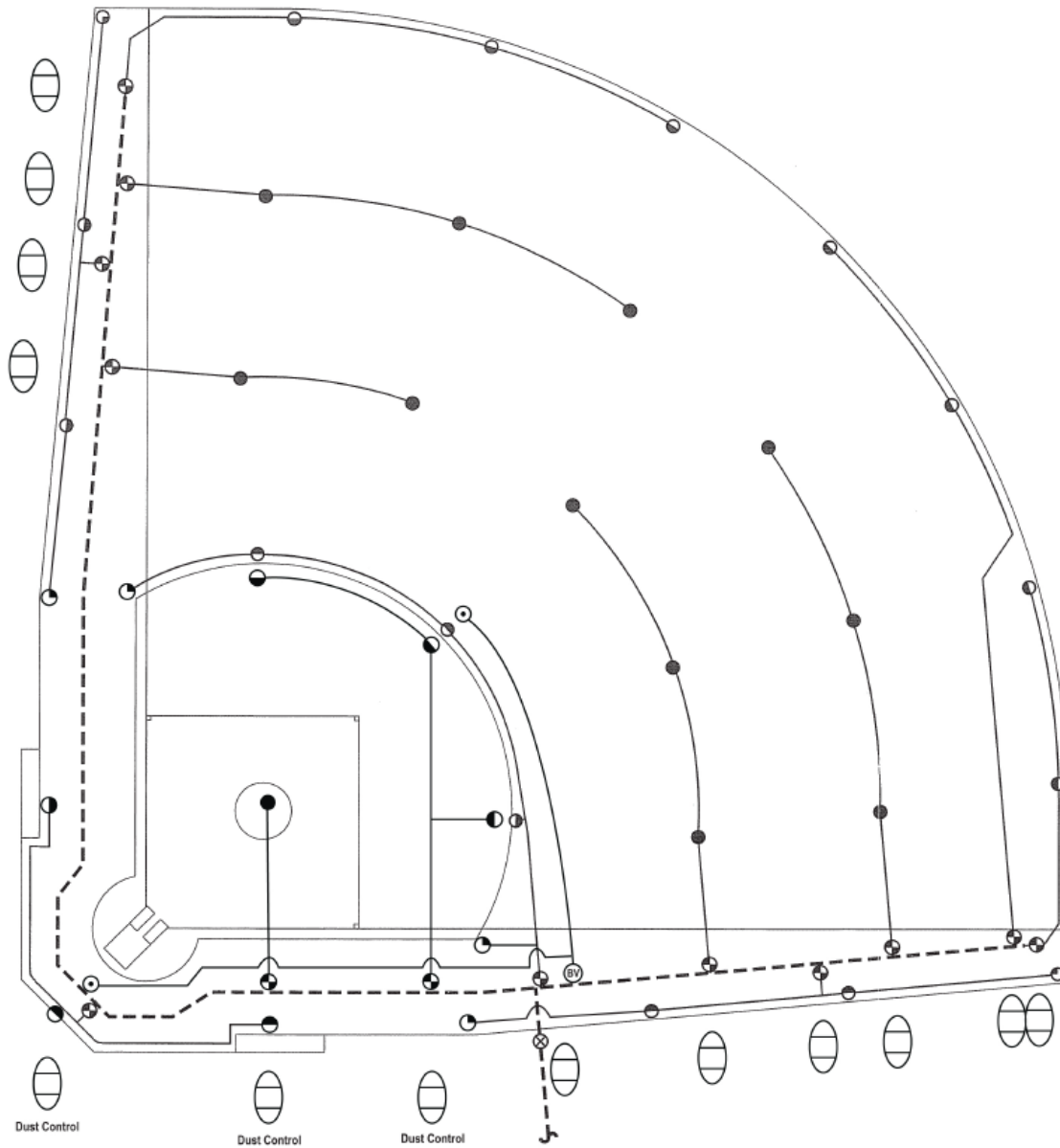

THIS FIGURE IS FOR ILLUSTRATIVE PURPOSES ONLY
ALL IRRIGATION HEADS FOR DUST CONTROL ARE TO BE PLACED IN TURF.

SOCCER FIELD IRRIGATION DESIGN

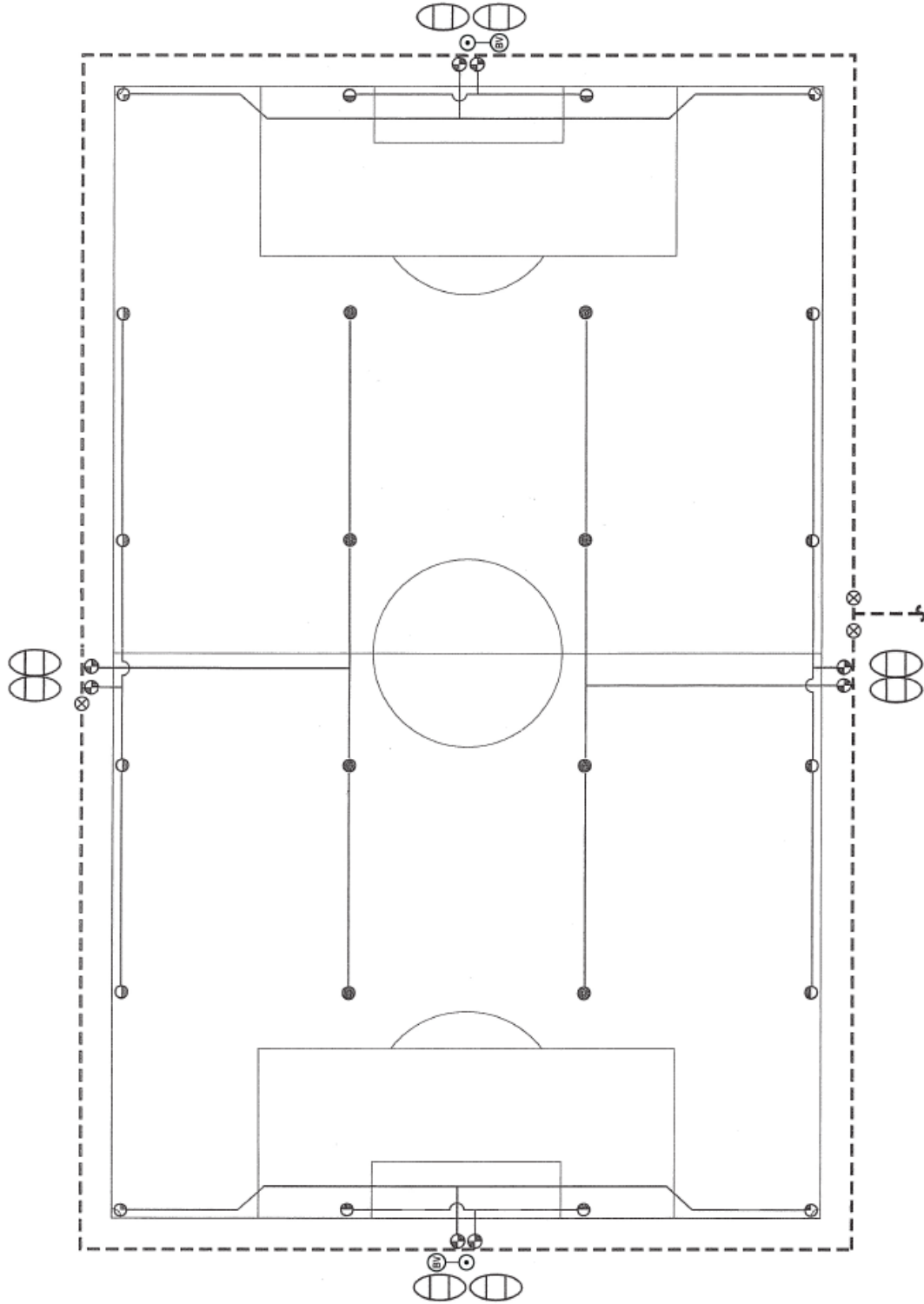

THIS FIGURE IS FOR ILLUSTRATIVE PURPOSES ONLY

ALL IRRIGATION HEADS FOR DUST CONTROL ARE TO BE PLACED IN TURF

LITTLE LEAGUE FIELD IRRIGATION DESIGN

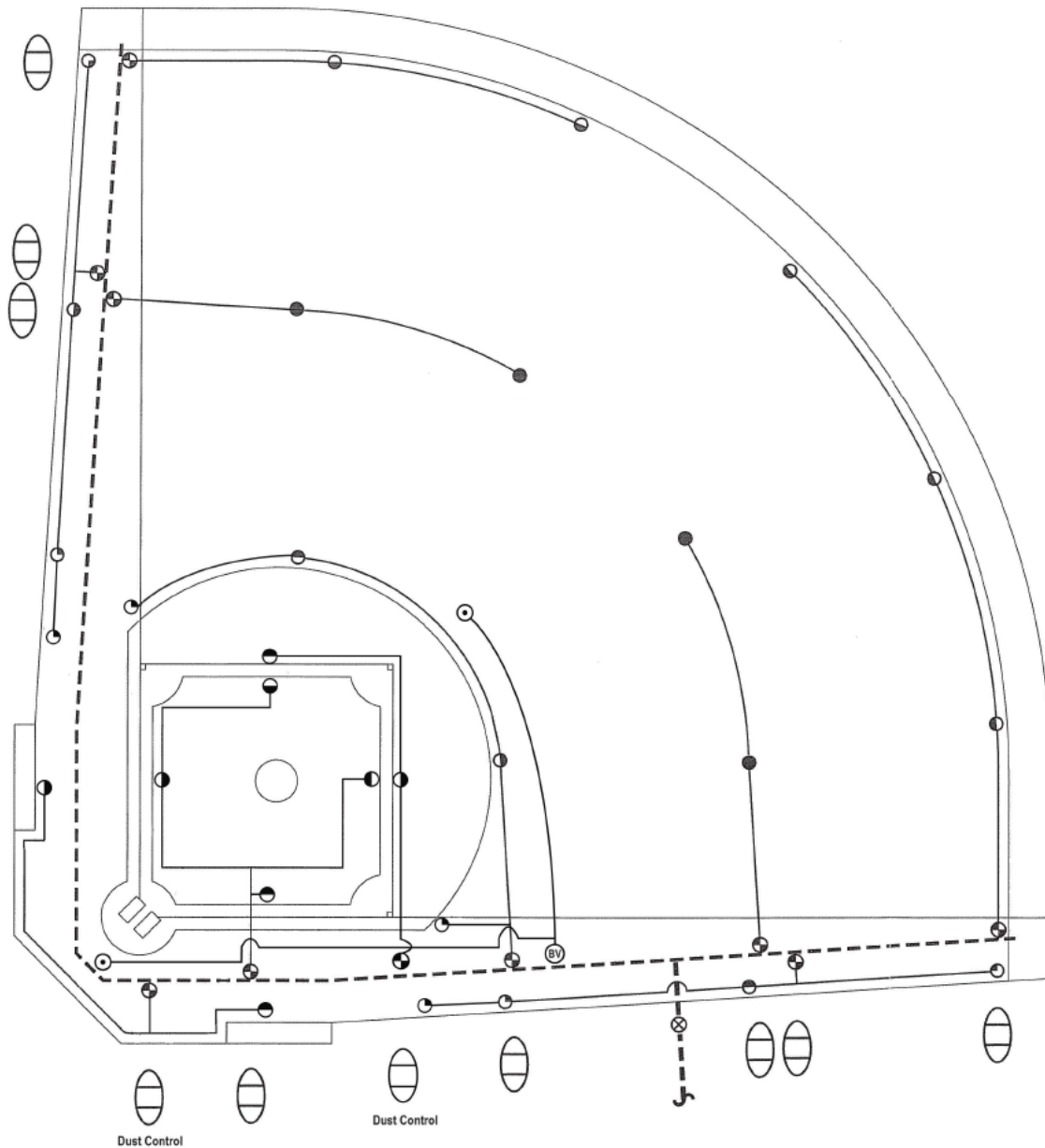

THIS FIGURE IS FOR ILLUSTRATIVE PURPOSES ONLY
ALL IRRIGATION HEADS FOR DUST CONTROL ARE TO BE PLACED IN TURF.

Section 8-3

NON-PAVED TRAILS

8-3

This section addresses the planning, design, maintenance and construction of trails within the city excluding the Scottsdale McDowell Sonoran Preserve trails. The term “trails” refers to unpaved, non- motorized, shared-use trails, which are legally accessible by the general public.

GENERAL INFORMATION

8-3.000

The city's goal is to develop and maintain a citywide interconnecting network of trails to provide valuable recreation and transportation opportunities for city residents and visitors. Trails function as transportation links between schools, residential areas, parks, places of employment, shopping areas and other areas of interest. Trails also provide hikers, walkers, joggers, equestrians, mountain bicyclists, and people with disabilities opportunities to improve health and fitness, spend time with family and friends, enjoy the natural environment and escape the stress of everyday life.

Several trails plans must be consulted for identifying trail alignments within the city. The Trail Master Plan approved by the City Council in February 2004 identifies trail locations citywide.

In 2008, the Ad Hoc Citizen Trails Task Force began meeting at Council's direction to update existing trail classifications and design guidelines. Their recommendations were approved by Council in March 2009 and are reflected in this document.

Additional detailed plans provide guidance for developing trails specifically within the McDowell Sonoran Preserve; contact Preserve staff.

REFERENCES

8-3.001

The following publications or their current revisions are to be used in conjunction with the design criteria in this manual when designing unpaved trails for the city:

- A. Public Rights-of-Way Access Advisory Committee's Accessible Public Rights of Way Planning and Design for Alterations (2001) and Access Board's Outdoor Developed Areas (1999).
- B. United States Access Board Revised Draft Guidelines for Accessible Public Rights-of-Way
- C. Forest Service Equestrian Design Guidebook for Trails, Trailheads, and Campgrounds (2008).
- D. Rails-to-Trails Conservancy Trails for the Twenty-First Century (2006).
- E. United States Department of Agriculture (USDA) Designing Trails and Sidewalks for Access Parts 1 and 2 (2001).
- F. USFS Trail Construction and Maintenance Notebook (2007),
- G. Pedestrian and Bicycle Information Center

REFERENCES

8-3.002

A. Primary Trails

The management objective for Primary Trails is to provide both transportation and recreation links between residential areas, schools, businesses, parks, places of employment and other areas of significant community activity. Primary Trails will typically experience the highest use levels. User groups include hikers, equestrians and bicyclists. Motorized vehicles are only permitted for maintenance and emergency purposes. The trail surface may be comprised of either native soil or decomposed granite. Urban Trails have the greatest width of all trail classifications and therefore accommodate leisurely side-by-side travel and easy passing for

multiple user types. These trails are typically located within areas of relatively level topography.

B. Secondary Trails

The management objective for Secondary Trails is to provide secondary transportation and recreation links through areas such as desert washes, scenic and vista corridors, and other desert open space areas. Secondary Trails typically experience a lower level of use than Primary Trails. User groups include hikers, equestrians and bicyclists. Motorized vehicles are only permitted for maintenance and emergency purposes and where trail widths allow. Secondary Trails are narrower than Primary Trails; therefore, occasional single-file travel by users may be required. These trails are typically located within areas of level to moderate topography.

C. Neighborhood Local Trails

The management objective for Neighborhood Local Trails is to provide access in and around neighborhood areas and provide connections to Primary and Secondary Trails. These trails typically act as “feeder” trails to the more regional trail network and may provide close-to-home recreational opportunities. User groups include hikers, equestrians and bicyclists. Motorized vehicles are only permitted for maintenance and emergency purposes, and where trail widths allow.

D. Minimally Improved/Rugged Trails

The management objective for Minimally Improved/Rugged Trails is to provide a minimally improved non-paved trail for recreation use designed for equestrian, hiker, runner and mountain bike, placed as far away from traffic as possible. This type of trail is to be constructed in areas where there are other accessible trail options available or where the construction of an accessible trail will substantially alter the character of the surrounding area, will impact culturally significant areas, or is difficult to construct because of the terrain such as washes. Motorized vehicles are only permitted for maintenance and emergency purposes and where trail widths allow.

TRAIL DESIGN

8-3.100

The city’s objective is to design, construct and maintain trails that:

- A. Provide safe, non-motorized transportation links, and/or close-to-home recreation opportunities.
- B. Provide legal public access to destination points and other areas of interest.
- C. Blend with the surrounding environment.
- D. Minimize impacts on the natural environment.
- E. Minimize impacts on adjacent landowners.
- F. Require minimum levels of maintenance.

DESIGN CONSIDERATIONS

8-3.101

A. Human Factors

Trails must be planned and constructed with the needs of the trail user in mind. Trail users tend to desire routes that access and connect areas of significant community activity such as schools, businesses, shopping areas and parks, as well

as other areas of interest such as viewpoints, water sources, natural areas, desert preserves, scenic and vista corridors, and interesting geologic features. Visual qualities are important to trail users; therefore, trails should be designed to blend with the surrounding environment. Views from the trail to the surrounding environment should also be considered. Trail users enjoy changes in scenery, thus the increasing demand for loop trails and trail networks that allow the user to return to the starting point without traveling the same trail twice. Loop trails also provide the comfort of knowing that the trail will return to the starting point, thus reducing the chance of anyone becoming lost. Trail users tend to favor the easiest, most obvious route. If the designated trail is not the easiest and most obvious, trail users will begin to create new, unauthorized trails.

B. Coinciding Easements

Trails are frequently located within common tracts and easements dedicated for other purposes such as drainage, flood control, public utility, natural area open space, and scenic and vista corridors. In situations where these common tracts and easements are wider than that needed for a trail easement, it is recommended to dedicate the same area of these coinciding common tracts and easements for the purposes of public trail use. This will increase the flexibility to properly layout, design and construct public trails, and will allow the trail to be positioned away from undesirable areas such as low-flow drainage channels, areas of extreme topography, dense vegetation, critical animal habitats and adjacent properties. This will also allow future realignment of the trail, should such realignment become necessary. In cases where a separate width of trail easement is delineated within other easements or common tracts, it is extremely important that the alignment of the trail easement be reviewed in the field to assure suitability.

C. Trail Viewshed

The lines of sight from a trail to the surrounding landscape and from the surrounding landscape to a trail are important design considerations. Views from the trail to the surrounding landscape improve the quality of the trail users' experience; therefore, trails should be designed to provide users varying views of the surrounding area. However, obscuring views of the trail from the surrounding landscape is also important, since adjacent landowners may not want to view the trail from their properties.

D. Native Plants

The design, construction and maintenance of trails within the city must consider the Native Plant Ordinance, Section 7.500 of the city's Zoning Ordinance. Trails should be aligned to avoid disturbance of, and have a minimum effect on the following plant species: whitethorn acacia, catclaw acacia, crucifixion thorn, hackberry, blue palo verde, foothill palo verde, desert willow, juniper, ironwood, cottonwood, mesquite, scrub oak, sugar sumac, Arizona rosewood, saguaro, barrel cacti, ocotillo, and soap tree yucca.

E. Sensitive Wildlife Habitat

Trail design and construction within natural desert park and preserve areas should be evaluated in terms of the effect that the trail will have on sensitive wildlife habitats. The Arizona Game and Fish Department should be consulted during the

trail design process to assure that the trail will not have a negative impact on such resources. The best means of preventing negative impacts on wildlife is to simply avoid sensitive areas. Seasonal trail closures may be necessary in some situations.

F. **Archaeological and Cultural Resources**

Trail design and construction should be evaluated in terms of the effect the trail will have on archaeological and cultural resources. Such activities should be done in accordance with the City of Scottsdale Archaeological Ordinance. Potential options to prevent and mitigate damage to these resources include:
 Altering the trail alignment to avoid archaeological and cultural resources.
 Protecting the resources by utilizing methods to obscure them from view.
 Mitigating the cultural resource, this involves removal and thorough documentation of the items by a professional archaeologist. The documentation of the resource may then be interpreted as part of the trail opportunity.

G. **Design for Shared-Use**

Trails within the city are open to all non-motorized uses unless otherwise stated. Decisions to prohibit any non-motorized use from trails must be based on coordinated planning efforts involving appropriate user groups and city staff. Characteristics that should be considered as part of this process include, but are not limited to, longitudinal and cross slopes, surface materials, line of sight, amount of use, sensitivity of surrounding environment, soil types, and native plant and animal habitats.

The following means of preventing potential user conflicts are based on methods identified in "Conflict on Multiple Use Trails" (Moore, 1994), and should be considered when planning, designing, constructing and maintaining shared-use trails:

Separate user types at trailheads and along the first, most crowded stretches of trail.

Provide adequate sight distances.

Build trails wide enough to accommodate expected levels and types of use.

Build and maintain trails wide enough for safe passing and/or provide periodic turnouts.

Design trails to control speeds where necessary by varying the trail surface and avoiding long, straight, downhill stretches.

Provide adequate trailhead facilities for all user types.

TRAIL LOCATIONS

Location work must begin early in the trail design process and be completed prior to construction. The amount and level of work that is required varies depending on the type of trail being designed and the terrain on which the trail is being constructed. The necessary steps to properly layout the trail include the following: Reconnaissance, Grade, Drainage and Staking/Flagging, refer to Paragraphs A through D below.

A. **Reconnaissance**

The reconnaissance process includes the identification and evaluation of alternative routes, which leads to final selection of the best possible route to meet the established objectives. Application of sound principles of trail location, alignment and grade will minimize future operation and maintenance problems.

8-3.102

B. Grade

The first step is to examine the most recent topographic maps and aerial photos of the area to identify significant landforms, drainage patterns and vegetation. The next step, for which there is no substitute, is to walk the area and examine potential routes. Conduct a systematic study of the area by walking various routes and viewing the area from different vantage points. Control points, which are features that are favorable for or inhibit trail construction, should be identified through this process. The control points will help to identify the best possible route, with the understanding that situations may exist where a trail must pass through negative control points.

Control points that are favorable for trail construction:

Existing road crossings (underpasses, overpasses and intersections with traffic lights or stop signs)

Areas of light vegetation

Natural desert wash crossings

Scenic vistas

Ridgelines

Areas of well drained soils

Hillside benches

Good trailhead access

Control points that inhibit trail construction and should be avoided:

Wet areas and poorly drained flat areas

Frequent desert wash crossings

Sensitive wildlife habitats

Locations requiring bridges or culverts

Desert wash bottoms

Areas of heavy or fragile vegetation

Areas adjacent to sources of excessive noise, such as airports

Areas requiring switchbacks

Areas of archaeological/cultural sensitivity

Areas adjacent to plants which are poisonous to horses, such as oleanders

Steep rocky slopes

Lightning-prone areas

Unstable or fragile soils

Unsafe or uncontrolled road crossings

Abrupt topographic changes

Known habitats of threatened or endangered plant or animal species

Bluffs, ledges and cliffs except where featured as scenic resources

C. Drainage

Proper drainage of surface water is the most important factor in design, construction and maintenance of trails. Surface erosion resulting from improper drainage will have a detrimental impact on the trail surface, causing damage to the natural environment and increasing maintenance requirements. The potential for erosion depends on three factors: soil type, velocity of water on the trail, and the distance water travels down the trail. Alteration of any of these factors can reduce

the potential for erosion. Proper outsloping of the trail tread and the installation of grade dips or water bars will help decrease the potential for erosion of the trail surface. If distances allow, grade dips are preferred over waterbars. Existing drainage patterns of the surrounding area, such as concentrated drainage channels, must be maintained. Attempts to alter the existing drainage patterns will have a negative effect on the natural environment and will most likely result in severe damage to the trail.

D. **Staking/Flagging**

Stakes or flags act as a guide so that the alignment, grade and distances can be easily followed during construction. A clinometer, topographic map, compass, measuring tape and notebook are all necessary tools. Proper location of the flag line is easily accomplished with three people acting as surveyor, rod holder and recorder. Stakes or flags should be located along the trail centerline with the location of dips, walls and other special structures indicated with color-coded flagging. The trail alignment should pass through control points that are favorable for trail construction and avoid control points which will inhibit trail construction. Normally, trail alignments follow the contours of the land and consist of a series of gently sweeping curves. Long straight segments with sharp angular turns should be avoided.

TRAIL CLASSIFICATIONS

8-3.200

City of Scottsdale staff may allow deviations from the following guidelines under special conditions with the approval of the Transportation Director.

PRIMARY TRAILS

8-3.201

A. **Grade**

Maximum sustained grade should not exceed 5 percent. A maximum grade of 8 percent may be used for short distances not to exceed 200 linear feet.

B. **Tread**

The desired tread width for a Primary Trails is 12 feet with a minimum acceptable width of 10 feet. The trail tread should be comprised of native soils in undisturbed desert areas and decomposed granite in areas that have been graded, landscaped, or will otherwise remain significantly unnatural. Compaction of a native soil tread surface may be necessary to prevent damage from use and to increase resistance to erosion. If decomposed granite is used it must be ¼ inch minus, Madison Gold or similar, wetted and compacted to a 4-inch depth. A soil stabilizer may be added to the decomposed granite according to manufacturers' specifications. The trail tread must be smooth and free of all obstacles. The trail tread must be delineated from the surrounding terrain. For example, utilizing decomposed granite of a different size or color in the surrounding landscape will help distinguish the trail tread. The location of landscape plants, fences and other physical barriers can also be used to delineate the trail.

C. **Vegetation Clearance**

Trails should be designed to have a minimum impact on plants identified for protection in the Native Plant Ordinance. Trail alignments that avoid and have the

least impact on surrounding vegetation are preferred. If the trail must pass within an unacceptable distance to any plants, the preference is to relocate the plants rather than destroy them.

Vegetation may not exceed a mature height of 3 feet within a 3-foot distance of the trail tread. Vertical clearance must be at least 10 feet above the trail tread, 12 feet is desired. This in no way implies that the trail corridor should be devoid of plants. Low growing desert shrubs such as bursage and brittlebush present no hazard to trail users; therefore, are acceptable to have within the clearing limits. The purpose of the vegetation clearing limits is to keep taller, potentially more dangerous plants such as thorny trees and larger cacti a safe distance from the trail. All remaining roots and stumps must be grubbed out of the trail surface to provide a smooth tread. No teddy bear cholla may be located within 3 feet of the trail tread. In areas where new landscaping is to be installed, trees, cacti and other spiny plants must be planted at least 5 feet from the trail tread.

D. Drainage

The trail surface must have a cross slope of 3 to 5 percent. This is critical in preventing water from pooling on and channeling down the trail. If the trail traverses the side slope of a hill, the cross slope of the trail surface must be downward from the uphill to the downhill edge of the trail (outslope). This will allow surface water to drain off the edge of the trail rather than running down the length of the trail. The installation of erosion control structures such as water bars or grade dips may be required. The cross slope of such a trail tread must NOT be downward from the downhill to the uphill edge of the trail (inslope). Such a scenario will result in water channeling down the length of the trail, causing extreme levels of erosion. If the trail is located on level ground, the trail surface should be crowned to drain water off both sides of the trail and prevent pooling.

E. Easement Widths and Setback from Street

Primary Trails may be contained in a minimum 30-foot-wide trail or non-motorized public access easement or in ROW. In situations where a trail easement overlaps with common tracts or easements dedicated for other purposes, it may be beneficial to dedicate the entire width for public trail purposes. For more detail refer to Section 8-3.101. Trails along streets should be placed the maximum distance possible from the back of curb. The preferred separation is 50 feet with a minimum separation of 25 feet.

SECONDARY TRAILS

8-3.202

A. Grade

Maximum sustained grade should not exceed 5 percent. A maximum grade of 8 percent may be used for short distances not to exceed 200 linear feet.

B. Tread

The desired tread width for a Secondary Trail is 10 feet with a minimum acceptable width of 8 feet. The trail tread should be comprised of native soils in undisturbed desert areas and decomposed granite in areas that have been graded, landscaped, or will otherwise remain significantly unnatural. Compaction of a native soil tread surface may be necessary to prevent damage from use and to increase resistance to erosion. If decomposed granite is used, it must be ¼ inch minus, Madison Gold

or similar, wetted and compacted to a 4-inch depth. A soil stabilizer may also be added to the decomposed granite according to manufacturers' specifications. The trail tread must be smooth and free of all obstacles. The trail tread must be delineated from the surrounding terrain. For example, utilizing decomposed granite of a different size or color in the surrounding landscape will help distinguish the trail tread. The location of landscape plants, fences and other physical barriers can also be used to delineate the trail.

C. Vegetation Clearance

Trails should be designed to have a minimum impact on plants identified for protection in the Native Plant Ordinance. Trail alignments that avoid and have the least impact on surrounding vegetation are preferred. If the trail must pass within an unacceptable distance to any plants, the preference is to relocate the plants rather than destroy them.

Vegetation may not exceed a mature height of 3 feet within a 3-foot distance of the trail tread. Vertical clearance must be at least 10 feet above the trail tread, 12 feet is desired. This in no way implies that the trail corridor should be devoid of plants.

Low growing desert shrubs such as bursage and brittlebush present no hazard to trail users; therefore, are acceptable to have within the clearing limits. The purpose of the vegetation clearing limits is to keep taller, potentially more dangerous plants such as thorny trees and larger cacti a safe distance from the trail. All remaining roots and stumps must be grubbed out of the trail surface to provide a smooth tread. No teddy bear cholla may be located within 3 feet of the trail tread. In areas where new landscaping is to be installed, trees, cacti and other spiny plants must be planted at least 5 feet from the trail tread.

D. Drainage

The trail surface must have a cross slope of 3 to 5 percent. This is critical in preventing water from pooling on and channeling down the trail. If the trail traverses the side slope of a hill, the cross slope of the trail surface must be downward from the uphill to the downhill edge of the trail (outslope). This will allow surface water to drain off the edge of the trail rather than running down the length of the trail. The installation of erosion control structures such as water bars or grade dips may be required. The cross slope of such a trail tread must NOT be downward from the downhill to the uphill edge of the trail (inslope). Such a scenario will result in water channeling down the length of the trail causing extreme levels of erosion. If the trail is located on level ground, the trail surface should be crowned to drain water off the trail and prevent pooling.

E. Easement Width and Setback from Street

Secondary Trails may be contained in a minimum 25-foot-wide non-motorized public access easement or in ROW. In situations where a trail easement overlaps with common tracts or easements dedicated for other purposes, it may be beneficial to dedicate the entire width for public trail purposes, refer to Section 8-3.101 for more detail. Trails along streets should be placed the maximum distance possible from the back of curb. The desire separation for a Secondary trail is 25 feet with a minimum separation of 10 feet.

NEIGHBORHOOD TRAILS

A. **Grade**

Maximum sustained grade should not exceed 5 percent. A maximum grade of 8 percent may be used for short distances not to exceed 200 linear feet.

B. **Tread**

The desired tread width for a Neighborhood/Local Trail is 8 feet with a minimum acceptable width of 6 feet. The trail tread should be comprised of native soils in undisturbed desert areas and decomposed granite in areas that have been graded, landscaped, or will otherwise remain significantly unnatural. Compaction of a native soil tread surface may be necessary to prevent damage from use and to increase resistance to erosion. If decomposed granite is used it must be ¼ inch minus, Madison Gold or similar, wetted and compacted to a 4-inch depth. A soil stabilizer may also be added to the decomposed granite according to manufacturers' specifications. The trail tread must be smooth and free of all obstacles. The trail tread must be delineated from the surrounding terrain. For example, utilizing decomposed granite of a different size or color in the surrounding landscape will help distinguish the trail tread. The location of landscape plants, fences and other physical barriers can also be used to delineate the trail.

C. **Vegetation Clearance**

Trails should be designed to have a minimum impact on plants identified for protection in the Native Plant Ordinance. Trail alignments that avoid and have the least impact on surrounding vegetation are preferred. If the trail must pass within an unacceptable distance to any plants, the preference is to relocate the plants rather than destroy them.

Vegetation may not exceed a mature height of 3 feet within a 3-foot distance of the trail tread. Vertical clearance must be at least 10 feet above the trail tread. This in no way implies that the trail corridor should be devoid of plants. Low growing desert shrubs such as bursage and brittlebush present no hazard to trail users; therefore, are acceptable to have within the clearing limits. The purpose of the vegetation clearing limits is to keep taller, potentially more dangerous plants such as thorny trees and larger cacti a safe distance from the trail. All remaining roots and stumps must be grubbed out of the trail surface to provide a smooth tread. No teddy bear cholla may be located within 3 feet of the trail tread. In areas where new landscaping is to be installed, trees, cacti and other spiny plants must be planted at least 5 feet from the trail tread.

D. **Drainage**

The trail surface must have a cross slope of 3 to 5 percent. This is critical in preventing water.

E. **Easement Width and Setback from Street**

Neighborhood/Local Trails may be contained in a minimum 25-foot-wide non-motorized public access easement or ROW. In situations where a trail easement overlaps with common tracts or easements dedicated for other purposes, it may be beneficial to dedicate the entire width for public trail purposes, refer to Section 8-3.101 for more detail. Trails along streets should be placed the maximum distance

possible from the back of curb. The desired separation for a Neighborhood/Local Trail is 10 feet.

MINIMALLY IMPROVED / RUGGED TRAILS

8-3.204

A. **Grade**

Grade will match existing terrain.

B. **Tread**

The desired tread width is 4 feet. The trail tread is made up of native soils. Compaction may be used to prevent damage from use and to increase resistance to erosion.

C. **Vegetation Clearance**

Trails should be designed to have a minimum impact on plants identified for protection in the Native Plant Ordinance. Trail alignments that avoid and have the least impact on surrounding vegetation are preferred. If the trail must pass within an unacceptable distance to any plants, the preference is to relocate the plants rather than destroy them.

Vegetation may not exceed a mature height of 3 feet within a 3-foot distance of the trail tread.

Vertical clearance must be at least 10 feet above the trail tread, 12 feet is preferred. This in no way implies that the trail corridor should be devoid of plants. Low growing desert shrubs such as bursage and brittlebush present no hazard to trail users; therefore, are acceptable to have within the clearing limits. The purpose of the vegetation clearing limits is to keep taller, potentially more dangerous plants such as thorny trees and larger cacti a safe distance from the trail. All remaining roots and stumps must be grubbed out of the trail surface to provide a smooth tread. No teddy bear cholla may be located within 3 feet of the trail tread. In areas where new landscaping is to be installed, trees, cacti and other spiny plants must be planted at least 5 feet from the trail tread.

D. **Drainage**

The trail surface must have a cross slope of 3 to 5 percent. This is critical in preventing water from pooling on and channeling down the trail. If the trail traverses the side slope of a hill, the cross slope of the trail surface must be downward from the uphill to the downhill edge of the trail (outslope). This will allow surface water to drain off the edge of the trail rather than running down the length of the trail. The installation of erosion control structures such as water bars or grade dips may be required. The cross slope of such a trail tread must NOT be downward from the downhill to the uphill edge of the trail (inslope). Such a scenario will result in water channeling down the length of the trail causing extreme levels of erosion. If the trail is located on level ground, the trail surface should be crowned to drain water off the trail and prevent pooling.

E. **Easement Widths and Setback from Street**

Minimally Improved Trails must be contained in a minimum 25-foot-wide non-motorized public access easement if located in a trail corridor identified in the Trails Plan as a Secondary, Local, or Neighborhood Trail. Minimally Improved Trails must be contained in a minimum 30-foot-wide non-motorized public access easement if located in a trail corridor identified in the Trails Plan as a Primary Trail.

In situations where a non-motorized public access easement overlaps with common tracts or easements dedicated for other purposes, it may be beneficial to dedicate the entire width for public trail purposes, refer to Section 8-3.101 for more detail. Minimally Improved Trails must be located the maximum distance feasible from the edge of the street. The desired distance is 50 feet with the minimum distance 20 feet.

TREAD CONSTRUCTION

8-3.300

A. **Surface Materials**

Trail surface materials must correspond to the specification for the appropriate trail classification under Section 8-3.200.

B. **Cross Slope**

The cross slope, which is the slope of the tread surface perpendicular to the longitudinal slope, is a critical factor in the design, construction and maintenance of trails. The cross slope allows surface water to drain off the side of the trail rather than along the longitudinal slope. The three primary types of cross slopes are outslope, inslope and crowned. Outsloped and insloped trail surfaces typically occur on trails that traverse the side slope of a hill, and a crowned trail surface is typically found on trails that travel across relatively level ground, refer to Figure 8-3.1.

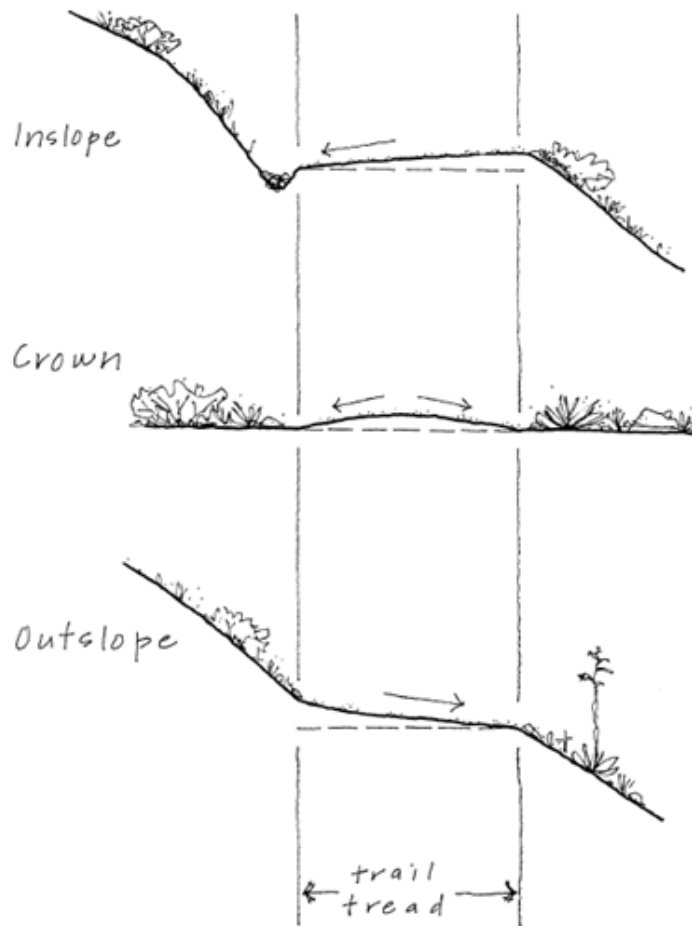

FIGURE 8-3.1 CROSS SLOPES

C. Outslope

Outslope is the most common type of cross slope used on trails that traverse the side slopes of hills and occurs when the trail surface slopes downward from the uphill to the downhill edge of the trail. Standard outslopes range from 3 to 5 percent, depending on the trail classification.

D. Inslope

Inslope is the most infrequent variety of cross slope used on trails that traverse the side slopes of hills and occurs when the trail surface slopes downward from the downhill to the uphill edge of the trail. Insloped trails are discouraged and only recommended when used as a component of switchback turns. Inslopes must be used in conjunction with rock-lined swales that collect the water and channel it away from the trail. The improper use of an insloped trail surface will cause extreme erosion to the trail surface and the surrounding environment; therefore, should not be built without consulting the City Trails Coordinator.

E. Crowned

A crowned surface is most commonly used on trails that traverse relatively level ground. A crowned trail surface slopes downward from the centerline to each

outside edge for the purpose of preventing surface water from pooling on the trail surface. The slopes from the centerline to each edge should be 5 percent.

F. Backslope

The backslope is the area from which material is excavated on the uphill side of the trail tread. Backslopes range from steep to gentle depending on the side slope of the hill and the characteristics of the soil. Generally, the backslope cannot be steeper than the soil's ability to remain in place under typical climatic conditions. Riprap on moderate backslopes and retaining walls on steeper backslopes may be needed to stabilize the backslope in areas with steep side slopes or unstable soils. The use of retaining walls to support the backslope will require excavating less material. Refer to Figure 8-3.2 on the following page.

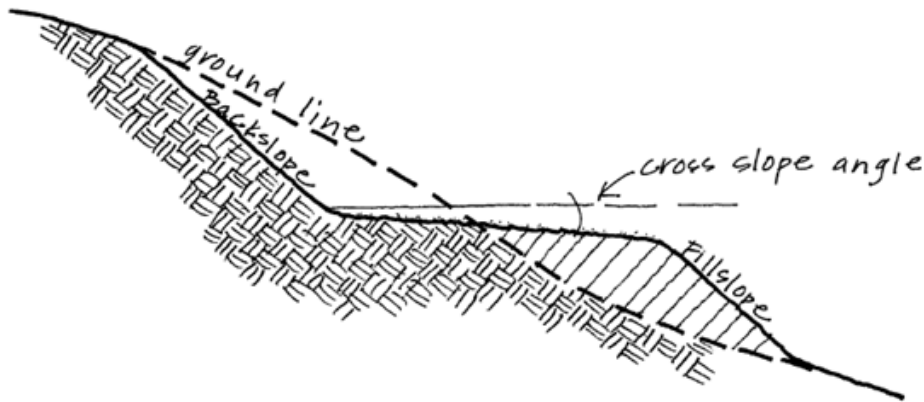

FIGURE 8-3.2 TYPICAL TRAIL PROFILE

G. Fillslope

Adding material to build up and support the downhill edge of the trail tread creates the fillslope. The material removed as parts of the backslope or from nearby borrow pits is often used in the fillslope. Riprap on moderate fillslopes and retaining walls on steeper fillslopes may be needed to support the fillslope in areas with steep side slopes or loose soils. The fillslope should be revegetated following construction to regain its natural appearance and to reduce the potential for erosion, see above Figure 8-3.2.

H. Typical Trail Cross-sections

Refer to Figure 8-3.3 for examples of trail construction for various side slopes.

Full Bench

Full bench construction involves the greatest amount of soil removal but provides the most stable trail surface. In this type of construction, soil is removed from the backslope and cast down the hill. The excavated material is not used as fill to support the trail tread. Instead, the entire trail tread is supported by solid mineral soil. Full bench construction is best suited for trails on steep side slopes greater than 50 percent because fill will erode easily.

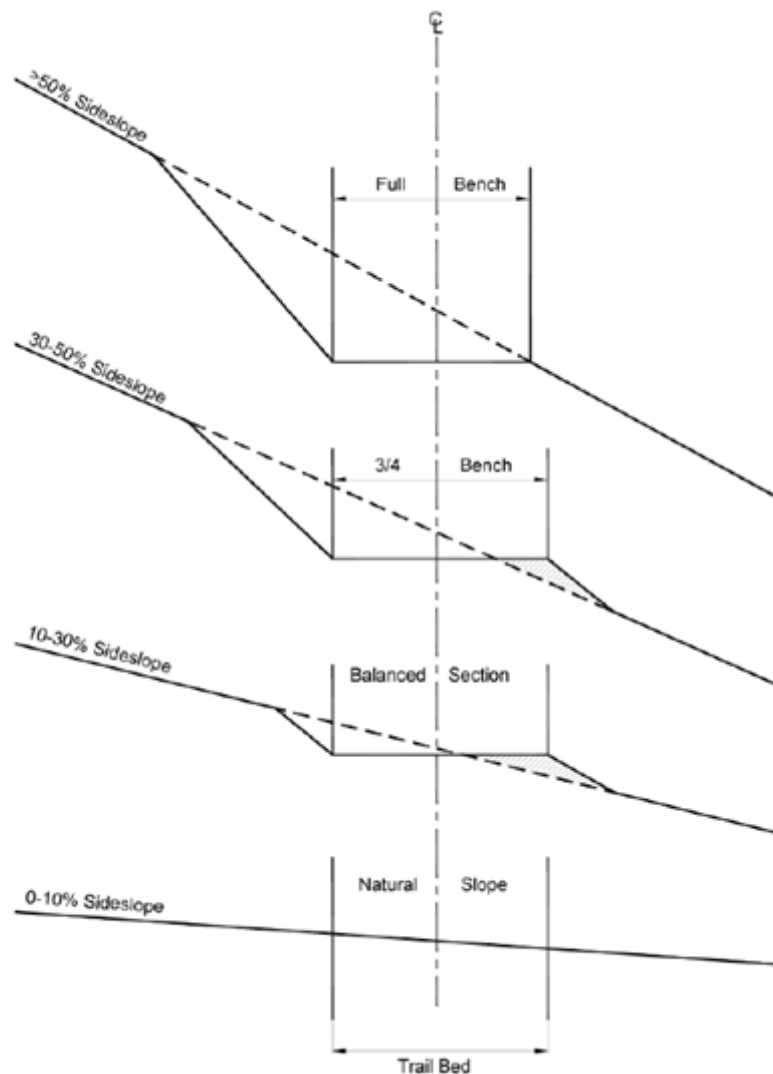

FIGURE 8-3.3 TYPICAL TRAIL CROSS SECTIONS

I. **3/4 Bench**

This type of trail construction should be used on side slopes of 30 to 50 percent. The soil excavated from the backslope should be used for the fillslope. The fillslope should represent the downhill $\frac{1}{4}$ of the trail width. The fillslope should be revegetated to restore its natural condition and reduce the potential for erosion.

J. **Balanced Section**

Balanced section trail construction should be utilized on side slopes of 10 to 30 percent. The soil excavated from the backslope should be used for the fillslope. The fillslope should represent the downhill $\frac{1}{2}$ of the trail width. The fillslope should be revegetated to restore its natural condition and reduce the potential for erosion.

K. **Natural Slope**

Natural slope construction is used when side slopes are less than 10 percent; it involves no cutting or filling, resulting in no backslope or fillslope.

8-3.301

VEGETATION CLEARANCE

Vegetation clearance is the removal of vegetation within specified clearing limits; refer to Section 8-3.200 for specifications for each trail classification. The primary goal is to provide the specified clearance while maintaining the maximum amount of vegetation and the natural characteristics of the area. Trails shall be aligned to prevent disturbance to plants identified in the Native Plant Ordinance. The trail should be aligned to avoid large-scale removal of native plants not covered by the Native Plant Ordinance.

When branches must be removed, pruning shall comply with ANSI Standard #A300, otherwise known as the 3-cut pruning method:

- A. One partial cut from the underside of the branch 6 to 8 inches from the trunk,
- B. A second cut from the top of the branch above the first cut to remove the branch, and
- C. The third cut to remove the stub.

Be sure not to cut into the branch collar, as this will damage the tree and slow the healing process. Chemical sealants should not be applied to native trees. Cholla and prickly pear cacti should be trimmed at the segment joints. Plants that must be completely removed should be cut as close as possible to the ground surface and dispersed in areas not clearly visible from the trail, or completely removed from the site. Refer to Figure 8-3.4.

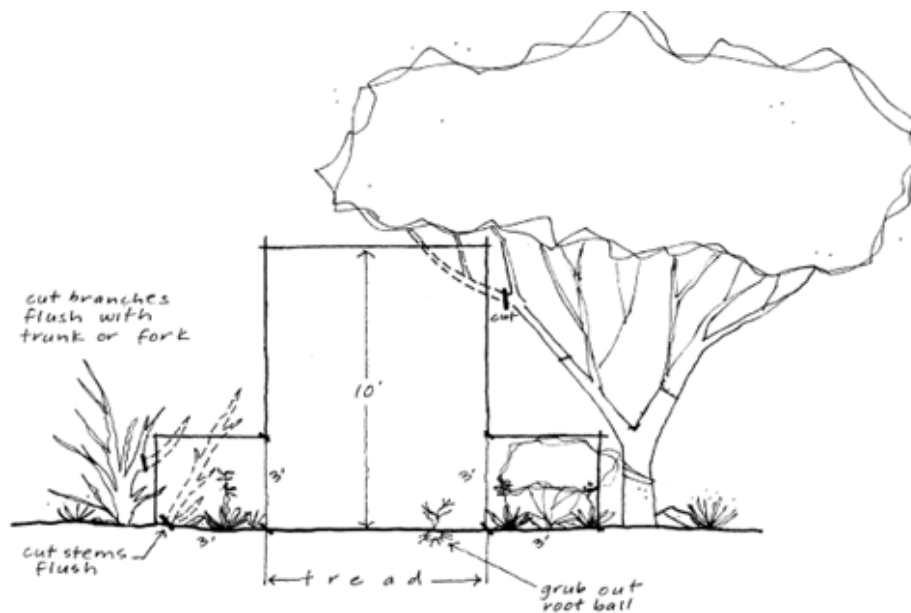

FIGURE 8-3.4 VEGETATION CLEARANCE

SURFACE WATER CONTROL

8-3.302

The proper control of surface water is a crucial element in trail design, construction and maintenance. Improper control will most likely have a negative effect on the surrounding environment and will result in damage to the trail that can be very expensive to repair. The need for surface water control structures depends on many

different factors including, but not limited to soil type, longitudinal and cross slopes and existing drainage patterns. The most effective time to address surface water control issues is during initial trail design and construction.

A. **Grade Dips**

Grade dips are short segments of trail with a grade opposite to the prevailing longitudinal grade of the trail. They are most effective when installed during new trail construction and sited to take advantage of natural drainage patterns. The low point of the dip must be outsloped at the maximum percentage permitted for the given trail classification to assure that water will flow off and away from the trail. A rock apron may need to be constructed where the water flows out of the dip to prevent excessive erosion. Grade dips are generally more effective than waterbars, require less maintenance, and are more suitable for equestrians and mountain bicyclists. See Figure 8-3.5 on the following page.

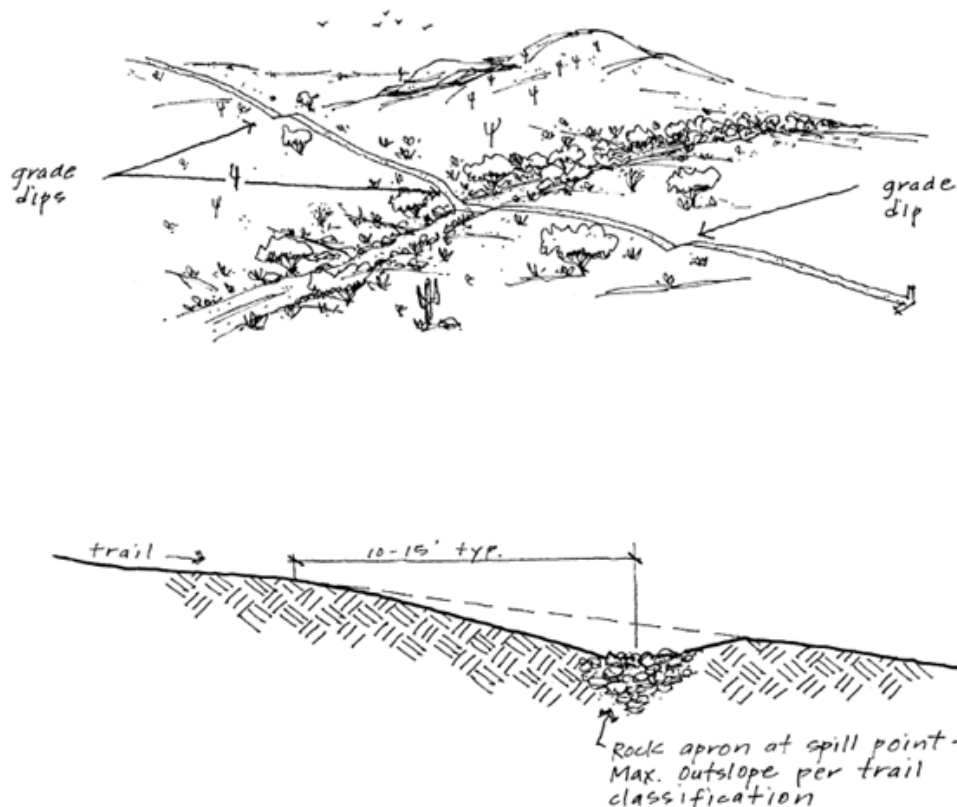

FIGURE 8-3.5 GRADE DIPS

B. **Waterbars**

Waterbars are native rocks or logs embedded in the trail surface at a 45-degree angle to the longitudinal slope for the purpose of directing surface water off the trail. Waterbars should extend at least 1-foot beyond each edge of the trail tread to ensure that water is diverted completely. Use fill material to build up the downhill side of the waterbar. Construct a drain ditch leading off the edge of the trail to

ensure that runoff flows away from the trail. The drain should be at least 1-foot-wide and 8 inches deep. Rocks should be placed in the bottom of the drain ditch to lessen the amount of erosion. Place additional rocks, logs, brush, or other debris in locations that will prevent trail users from detouring around the waterbar. Waterbars are not the preferred drainage structures on trails with large amounts of equestrian and mountain bicycle use. Grade dips are more appropriate in such situations.

C. Rock Waterbar

This type of waterbar is constructed by embedding large rectangular shaped rocks into the trail tread at a 45-degree angle to a depth roughly half their height. Rocks must be large enough to remain undisturbed by trail users and to effectively channel water off the trail. Rocks must be arranged in a shingle fashion, tightly overlapping each other towards the downhill side. Compact small rocks and fill around the base to ensure solid placement.

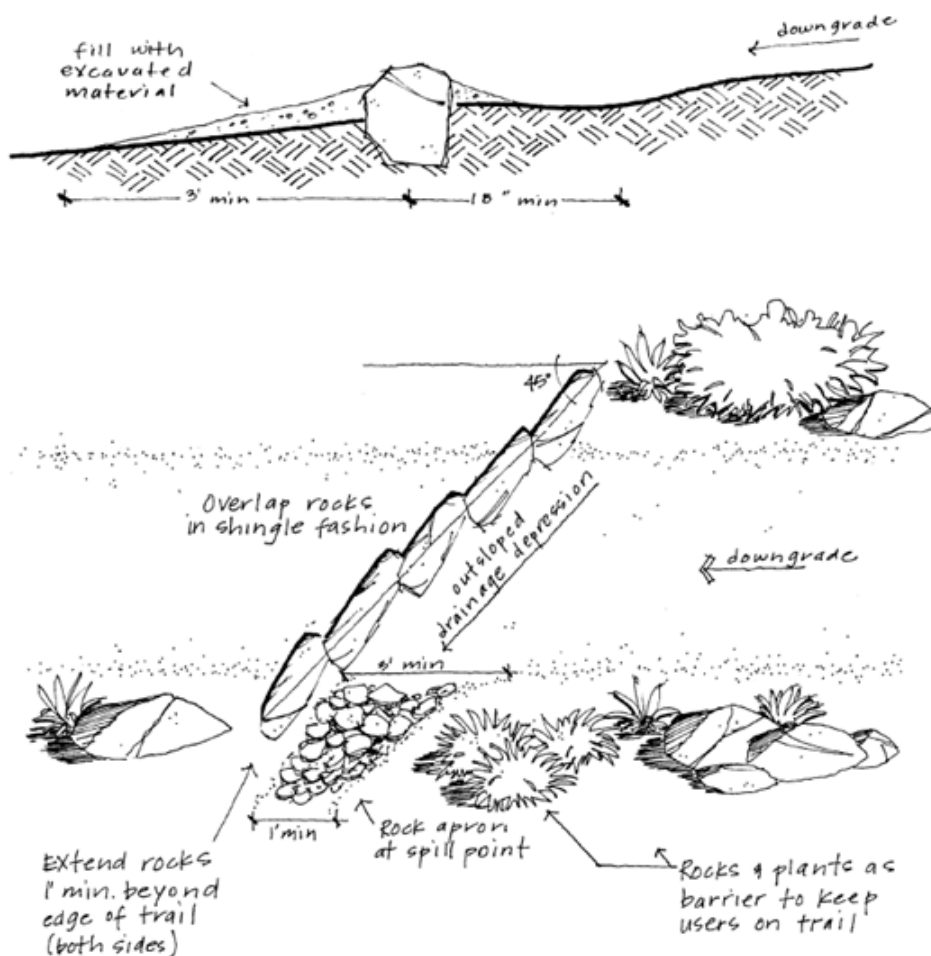

FIGURE 8-3.6 ROCK WATERBAR

D. Log Waterbar

A log waterbar is constructed by embedding solid, bark-free, rot-resistant timber into the trail surface at a 45-degree angle. Creosote-treated railroad ties or

telephone poles are not acceptable for use as waterbars. Logs must have a minimum of an 8-inch diameter and be embedded halfway into the trail surface. Log waterbars must be secured with two 18-inch-long, ½ inch-diameter pieces of rebar. Drill a 7/16-inch hole through the log, 8 inches from each end. Place the log in the desired location and drive the rebar through the holes into the trail surface until rebar is flush with the log surface. The Trails Planner must approve the use of log waterbars.

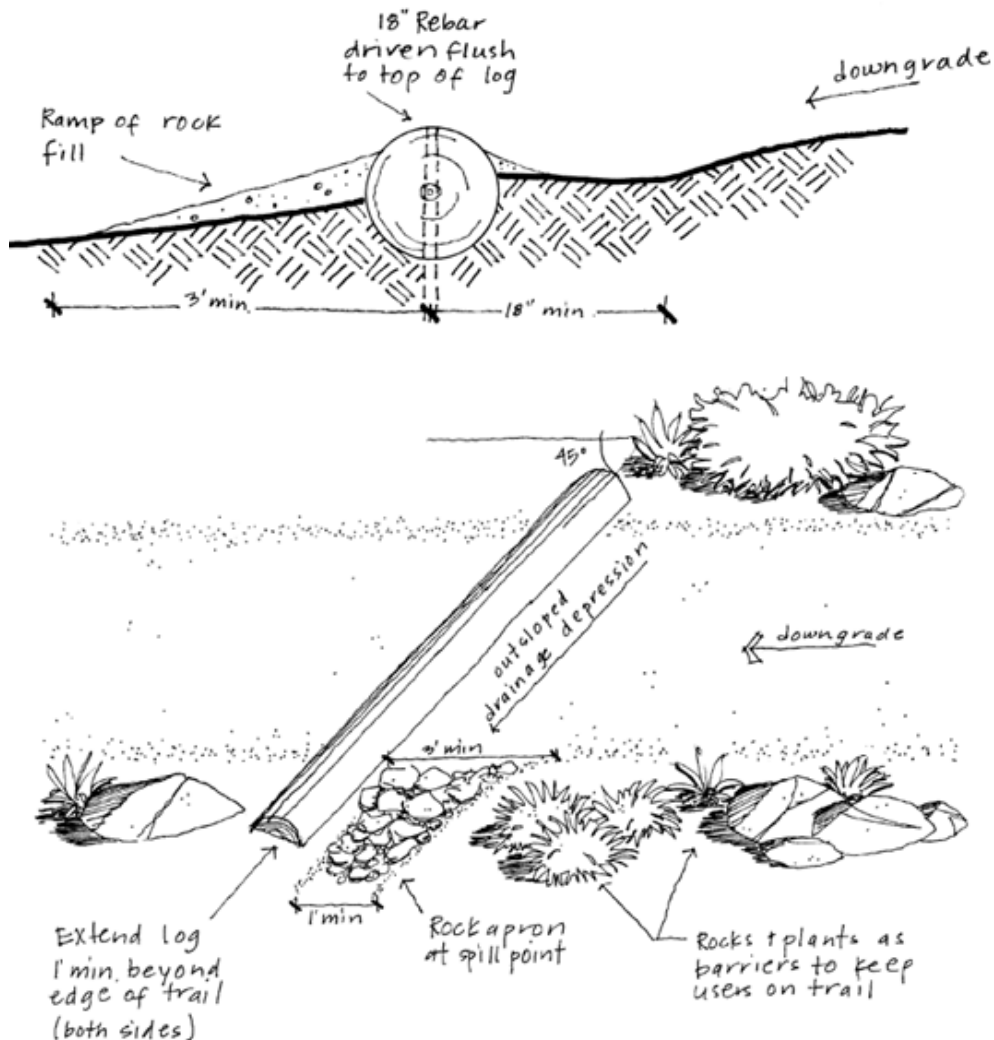

FIGURE 8-3.7 LOG WATERBAR

E. Culverts

In desert environments, most watercourses flow only seasonally, therefore culverts are usually not necessary. Culverts tend to be maintenance intensive and can detract from the aesthetics of the natural environment. Culverts should only be constructed where a gentle grade must be maintained such as with a Barrier-free Trail or where there is permanently flowing water. In all other situations, a desert wash crossing should be used, refer to Section 8-3.304. Rock or pipe culverts must match the downstream gradient and have a diameter of at least 12 inches to accommodate necessary cleaning. Improperly constructed culverts will clog with

debris, causing water to flow over and damage the trail tread. All rock used in the construction of culverts must be native.

F. Rock Culvert

The proper construction of rock culverts depends greatly on the proper selection and placement of rocks of sufficient size and shape. The bottom surface of the drainage must be armored with rocks to prevent erosion. Stone headwalls must be placed to armor the outside faces of the crossing. All rocks must be firmly placed similar to the construction of a retaining wall. Refer to Figure 8-3.8 on the following page.

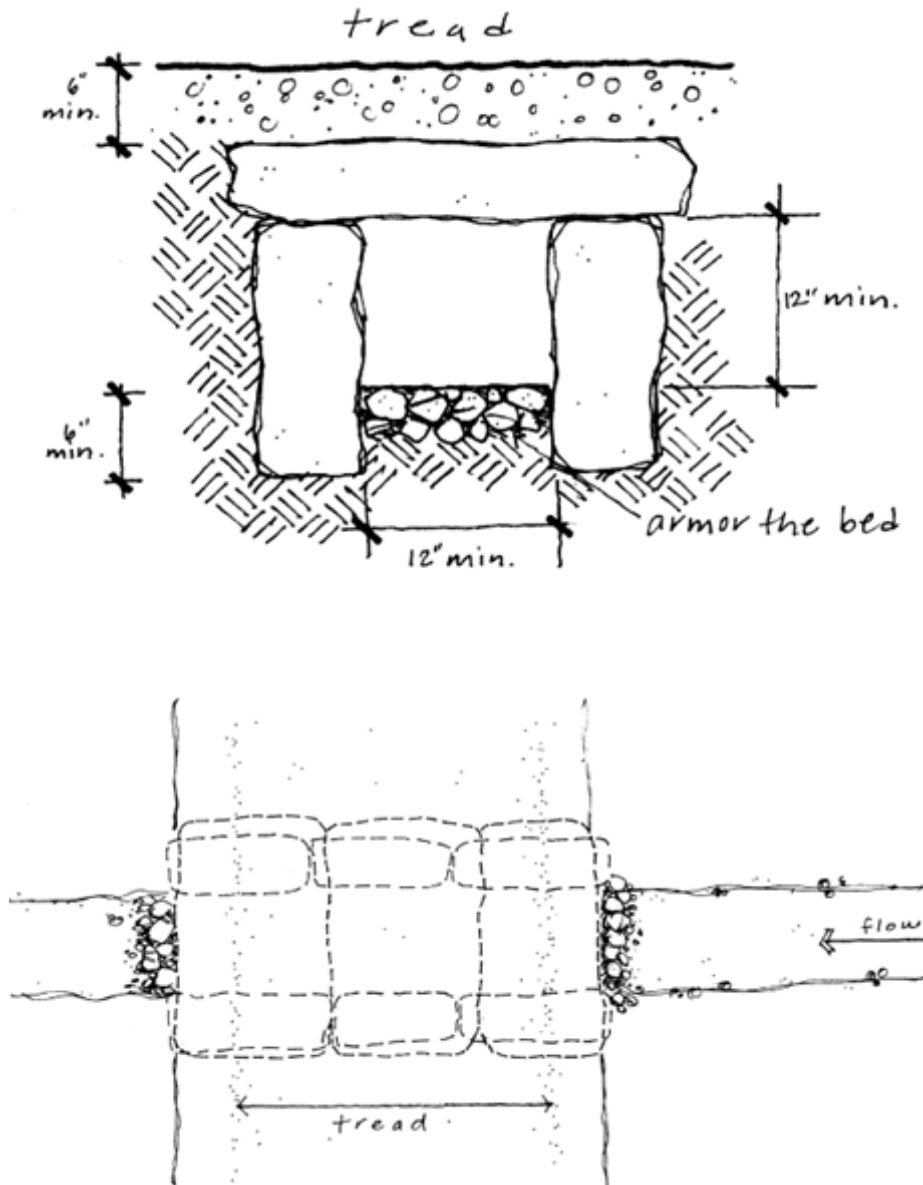

FIGURE 8-3.8 ROCK CULVERT

G. Pipe Culvert

Pipe diameter must be at least 12 inches. Embed the pipe in a stable foundation of gravel and soil and backfill with compacted gravel and soil. Construct a headwall of

firmly placed native stone to protect the outside faces of the tread crossing and cover the pipe so it cannot be viewed from the trail. The trail tread should be at least 6 inches higher than the top of the pipe. See Figure 8-3.9.

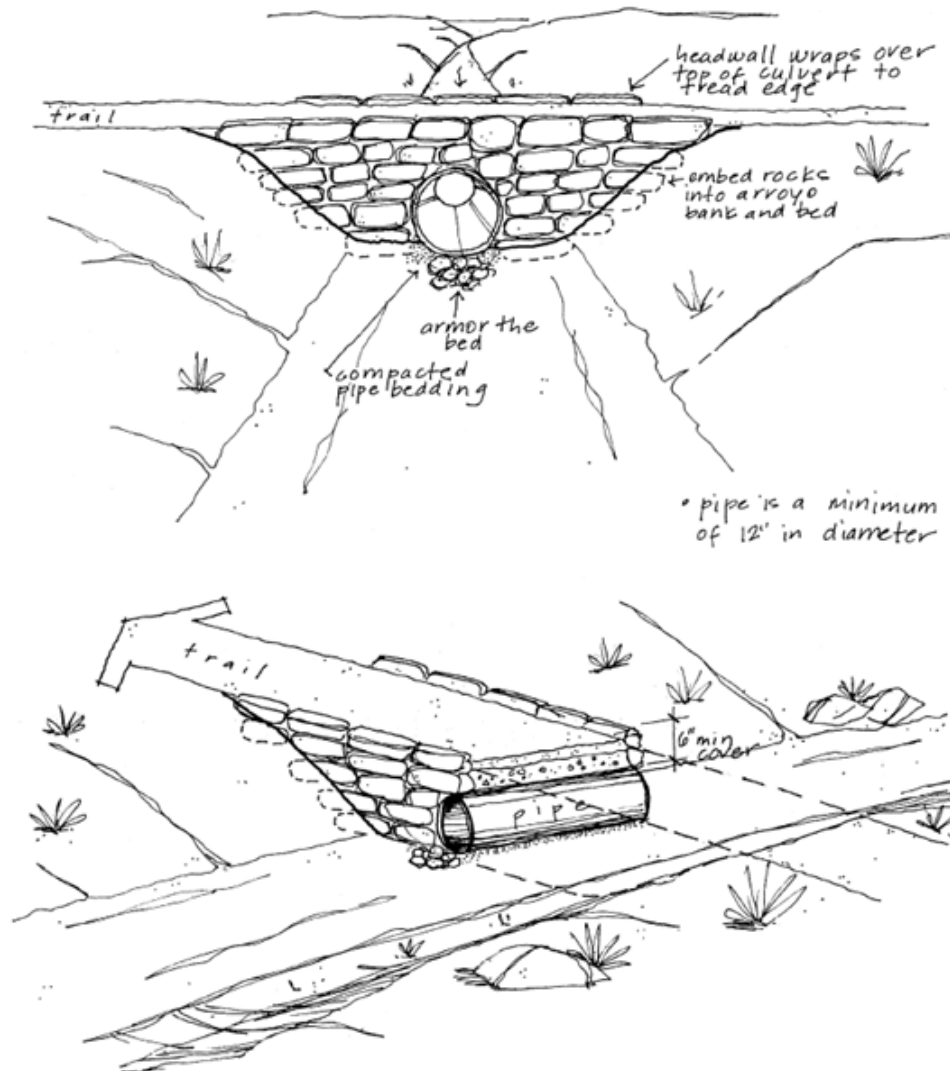

FIGURE 8-3.9 PIPE CULVERT

SPECIAL STRUCTURES

A. Retaining Walls

Retaining walls are stone structures used to stabilize trails on steep side slopes. A solid foundation is key to the strength and durability of a retaining wall. The foundation should be set in solid earth or rock, with the base sloped inward towards the hillside. Rock used in construction should be derived from the surrounding area. Ideal rocks are durable, weather resistant and free of structural defects. Large rocks should be used in the foundation, smaller rocks in the middle tiers and large rocks again for the upper tiers. Approximately 25 percent of the rocks used in the wall must be header stones.

A header stone is a rock placed with its longest dimension extending into the hillside, perpendicular to the face of the wall. All other rocks should be placed with

8-3.303

their longest dimension parallel to the face of the wall. Thickness of the wall should be at least $\frac{1}{2}$ its height, or 2 feet thick if the height is less than 5 feet. The outer face of the wall should slope inward towards the hillside at a rate of 3 inches per every 12 inches in height. Joints should be staggered at least 6 inches horizontally. Each rock should contact the rock below in at least three places. Shims must not be used because they are prone to shifting. If cement is used to provide additional stability, it must be colored to match the native rock. Backfill the wall with small stones and cover with soil until the proper tread surface is established. Refer to Figure 8-3.10 below.

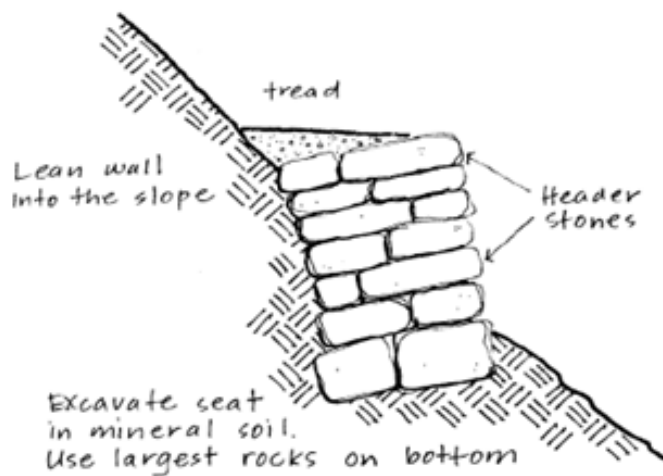
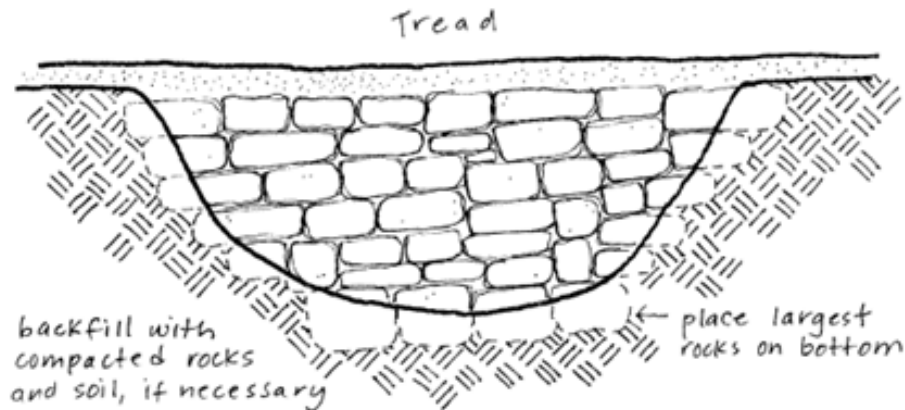

FIGURE 8-3.10 ROCK RETAINING WALLS

B. Riprap

Unlike a retaining wall, riprap does not support the weight of the trail tread. Instead, riprap is used to stabilize steep slopes above and below the trail tread (backslope and fillslope, respectively). Begin by clearing a firm foundation at the downhill edge of the riprap. Set the largest rocks in the foundation. Place smaller rocks on the surface of the slope continuing up the slope to the desired location. Be sure that the riprap does not impede the flow of surface water off the trail tread.

Riprap can also be used to protect drainage and leadoff ditches from heavy erosion and to stabilize switchback turns. Riprap should be constructed of native rock. If cement is used to provide additional stability, it must be colored to match the native rock. Refer to Figure 8-3.11 below.

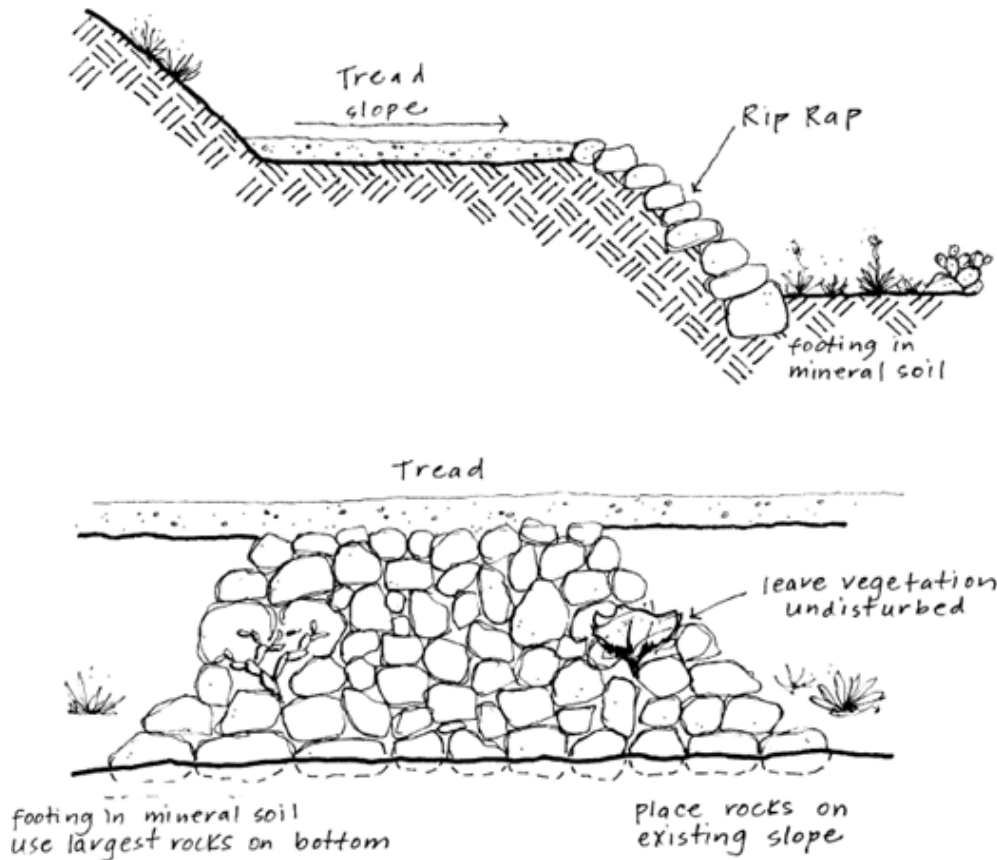

FIGURE 8-3.11 RIPRAP

C. Desert Wash Crossings

When trails cross washes, the greatest concern is protecting the trail from flowing water. The trail segments approaching the crossing and the location where the trail meets each edge of the desert wash must be stabilized with securely placed rocks. Trail segments approaching the desert wash should range from 5 to 15 percent for all trail classifications and cross at a 90-degree angle to the desert wash to prevent water from leaving the primary channel and flowing along the trail surface. The slopes adjacent to the trail may need to be stabilized with riprap. A row of large rocks should be embedded along the desert wash banks at the point of contact with the trail. Be sure that the flowing water will not undercut these rocks.

Refer to Figure 8-3.12 below.

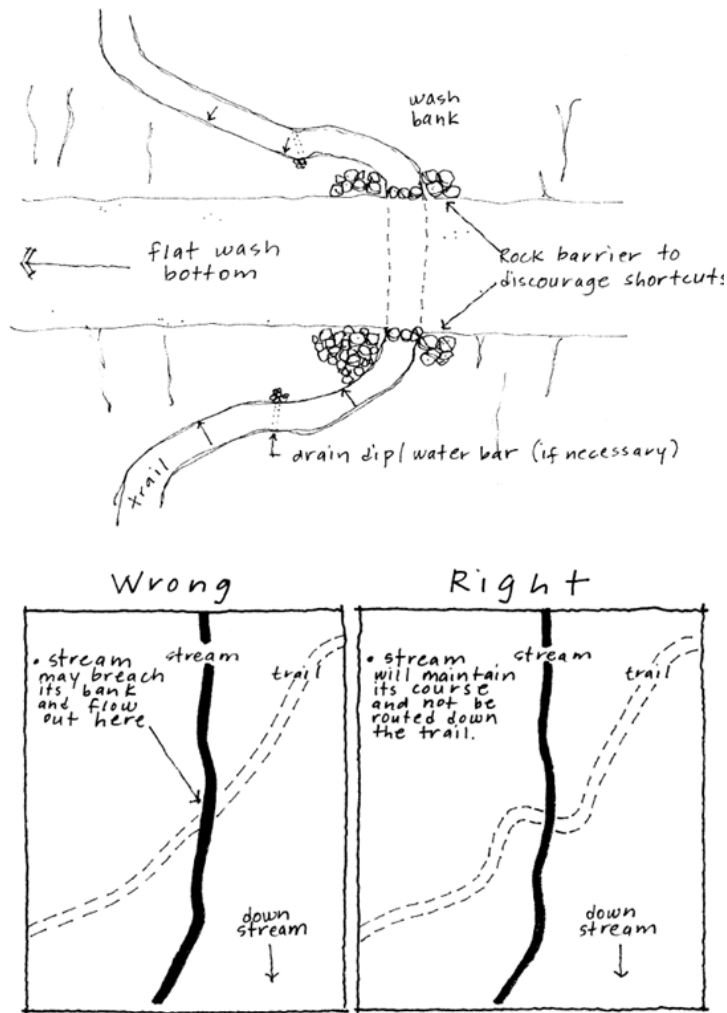

FIGURE 8-3.12 DESERT WASH CROSSING

D. Switchback and Climbing Turns

These two trail design elements are used to change the direction of travel on a hillside and to gain elevation in a short distance. The difference between is that climbing turns maintain a consistent longitudinal slope through the turn, while switchbacks have a near level landing at the turning point. These structures can be very difficult to construct, therefore careful planning should be conducted to avoid using them. The City Trails Coordinator should be consulted in situations where switchbacks may be necessary.

Avoid "stacking" a set of many short switchbacks and/or climbing turns on a hillside. Longer trail segments between switchbacks and/or climbing turns are less visible and reduce short cutting by trail users. Understanding the psychology of the trail user is important in the design of these structures. The layout must convince users that the established trail is the easiest, most convenient route to ascend the slope. If users feel it is not, they will create short cuts, refer to Figure 8-3.13 below.

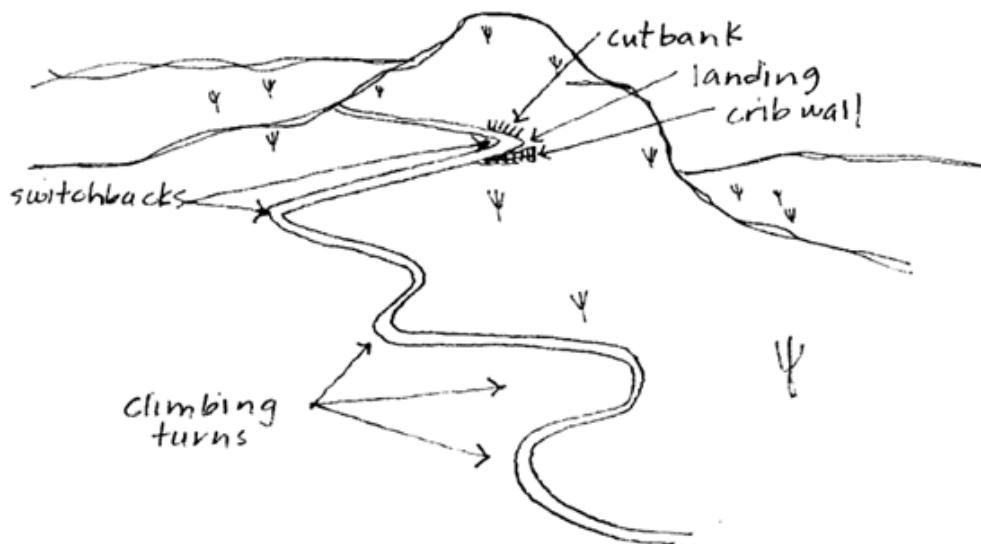

FIGURE 8-3.13 SWITCHBACK AND CLIMBING TURN CONCEPTS

E. Switchback Turn

Switchback turns are typically used on side slopes of 20 to 45 percent but can be used on slopes up to 55 percent with the use of retaining walls. These structures are extremely difficult and expensive to construct. Trail routes should be planned carefully to avoid areas of steep, impassible terrain that would require switchbacks. The key to a good switchback is proper placement on the terrain. Naturally occurring level areas or platforms are prime locations. Survey the hillside that the trail must ascend, locate the natural platforms and then connect the trail to these points. Trail segments leading to and away from the switchback must maintain the maximum longitudinal slope permitted for that trail classification. Locating switchbacks in areas where there are obstructions such as rock outcroppings or trees that will prevent short cutting is also desirable. Obstructions such as rocks, logs, or other debris may also be strategically placed to keep users from leaving the trail.

Switchbacks consist of 2 approaches, a landing or turn platform, a drain for the upper approach and platform, and guide structures. The upper approach and the upper half of the turn platform are excavated from the hillside. The lower approach and the lower half of the turn platform are constructed on fill. The construction of switchbacks on a full bench can be very labor intensive and expensive. The last 65 feet of each approach before reaching the turn platform should be as steep as the trail classification will allow. The last 10 feet of the approaches should be smoothly transitioned into the grade of the turn platform. A flat grade approaching the turn platform must be avoided because that design will cause trail users to short cut the switchback, refer to Figure 8-3.14 below.

As the upper approach descends toward the turn, a drain dip should be installed. Below this point, the tread and the upper half of the turn platform must be

insloped towards a drain ditch. The ditch must be 1-foot-deep and 1-foot-wide and have a rock apron at the spill point.

The turn platform must not exceed a slope of 5 percent. The upper side is excavated from the hillside. The removed soil is then used to fill in the lower portion. Riprap or retaining walls may be required to provide stability to the backslope and fillslope. The turning radius must be no less than 8 feet to provide adequate turning area for equestrians and mountain bicyclists. The lower portion of the turn platform and the lower approach should be outsloped. Riprap or a retaining wall may be needed along the inner portion of the switchback to maintain the backslope of the lower approach.

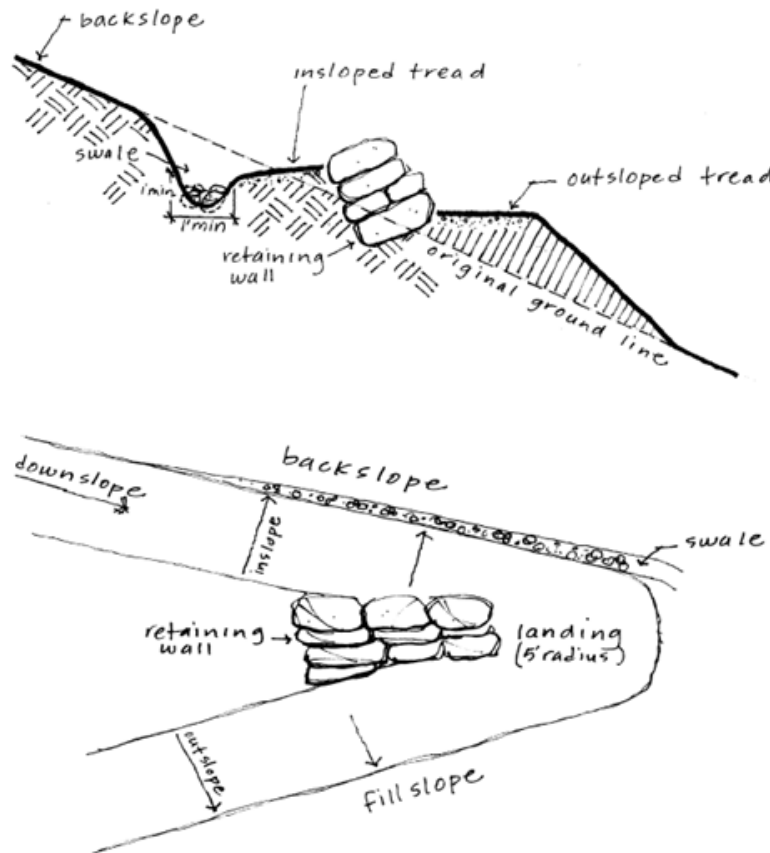

FIGURE 8-3.14 SWITCHBACK TURN

F. Climbing Turns

Climbing turns are like switchbacks because they are also used to reverse the direction of travel and gain elevation. Climbing turns differ however because they maintain a uniform longitudinal slope through the turn. There is no level turning platform. A climbing turn is built on the same slope as the hillside. Where the slope of the hillside turns, the climbing turn ascends at the same rate. Climbing turns must not be constructed on side slopes greater than 20 percent because they are prone to erosion. Climbing turns in appropriate terrain require very little work to construct. The approaches to the turn should be full bench construction. As the trail approaches the turn, the amount of excavation decreases. The turn itself

requires no excavation other than the removal of the surface layer of leaf litter. Refer to Figure 8-3.15 on the next page.



FIGURE 8-3.15 CLIMBING TURN

G. Steps

The use of steps should be avoided due to unsuitability for equestrians and mountain bicyclists and excessive maintenance requirements. Steps should be used on hiker-only trails when elevation must be gained rapidly over a short distance and there is no other option. Steps must not be used on trails intended for use by equestrians or mountain bicyclists. Steps should be constructed of rock collected from the surrounding area. Rocks should be rectangular, large enough to maintain their position (50 to 100 pounds each), and wide enough to span the width of the trail. Choose a location that will prevent trail users from traveling around the steps. Construction should begin with the lower steps and continue up the slope. Each step must be placed in an excavated seat and backfilled with small rocks and soil to assure stability. Refer to Figure 8-3.16 below.

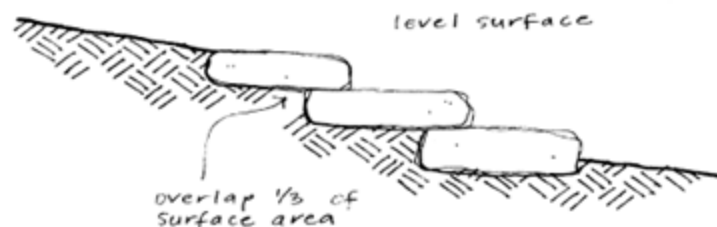

FIGURE 8-3.16 ROCK STEPS

H. Trail Safety Barriers

Trail Safety Barriers must comply with COS Standard Detail No. 2682.

Location

The location of safety barriers should not restrict sight distances for roadway traffic or trail users. Refer to Section 5.3 for roadway sight distance requirements. Special attention to the design and construction of barriers is particularly important near intersections. Safety barriers must be installed between a trail and a roadway if the trail is located within an unsafe distance to the roadway, or if the trail shares an

underpass or overpass with a roadway. Safety barriers must also be installed if the trail is elevated above an adjacent roadway and the side slope is greater than 6:1, or where trails are near other steep drop-offs. All safety barriers must be at least 3 feet from the edge of the trail.

I. Design Criteria

Appropriate safety barriers include fences, railings, or suitably thick vegetation. Other types of materials may be suitable after approval of the City Trails Coordinator. The materials and character of the barrier must be compatible with adjacent development, landscaping and topography. The minimum height should be 4 feet for structural barriers and 5 feet for vegetation barriers.

J. Trail Access Gates

Trail Access Gates must comply with COS Standard Detail No's. 2680-1 and 2680-2. These gates are designed to restrict motorized access to trails except as permitted for maintenance and emergency purposes. The gate design must permit equestrian passage without requiring the rider to dismount. These gates should be located at trailheads, where trails cross major roads, and at other points where motorized vehicles are likely to attempt to access a trail.

ROAD CROSSINGS

8-3.304

A. Overpasses

An overpass is a structure spanning a roadway, canal, or desert wash, etc. that functions exclusively as a crossing for a shared-use trail. There are many different varieties of overpasses that may be acceptable. The City Trails Planner must be involved in the planning and design process and must approve all overpasses prior to construction. In general, minimum clearance is 10 feet both horizontally and vertically.

B. Bridges

A bridge is a structure spanning a roadway, canal, desert wash, or other obstacle that serves as a crossing for a roadway as well as a shared-use trail. The City Trails Planner must be involved in the planning and design process and must approve all bridge crossings prior to construction. The minimum width of a trail crossing a bridge is 8 feet and the minimum vertical clearance is 10 feet.

C. Underpasses

These structures, used to provide passage for trail users under roadways, are typically constructed of pre-cast concrete box culverts. Other varieties of culverts are acceptable provided they meet the required dimensions and allow footing that is appropriate for all types of trail users. The width of a trail traveling through an underpass should not be less than 10 feet. Vertical clearance is an important concern, particularly for equestrian trail users. The minimum vertical clearance is 10 feet. Natural or vandal-resistant electric lighting should be installed for underpasses greater than 50 feet in length. Lighting shall achieve an average of 2-foot candles. Sight distances approaching and exiting the underpass must be adequate, to avoid creating a safety hazard. Underpass design should not allow for the accumulation of nuisance water on the trail. If water does not drain from the underpass by gravity flow, a pump system must be provided to remove the water.

The surface of the underpass should be slip resistant, such as broom finished concrete.

D. At-Grade Crossings

An at-grade crossing occurs where a trail passes across the surface of a roadway. Safety of trail users is the primary concern when planning at-grade trail crossings. Ideal locations for such crossings are at roadway intersections with light amounts of traffic that have existing stop signs, traffic lights, or designated pedestrian crossings.

Crossings should be on level grades where both trail users and motorists have long sight distances. Sight distances vary depending on the roadway classification; refer to Section 5.3 for more details. Additional safety precautions include installing pedestrian activated traffic signals, signs warning motorists of the trail crossing and signs warning the trail users of the road crossing.

TRAIL ACCESS FACILITIES

8-3.400

The design criteria for trail access facilities addressed in this manual are conceptual. The planning, design and construction of such facilities will be conducted on a case-by-case basis and will require various levels of city review and approval beyond the scope of this manual. Potential trailhead amenities include, but are not limited to, pull-through horse trailer parking spaces; regular vehicle parking spaces; potable drinking water; water troughs for horses; hitching posts or corrals; year-round natural shade areas; bike racks; informational, interpretive and directional signage; entrance gates; restrooms; shade ramadas; and picnic tables. Refer to Figure 8-3.17 below.

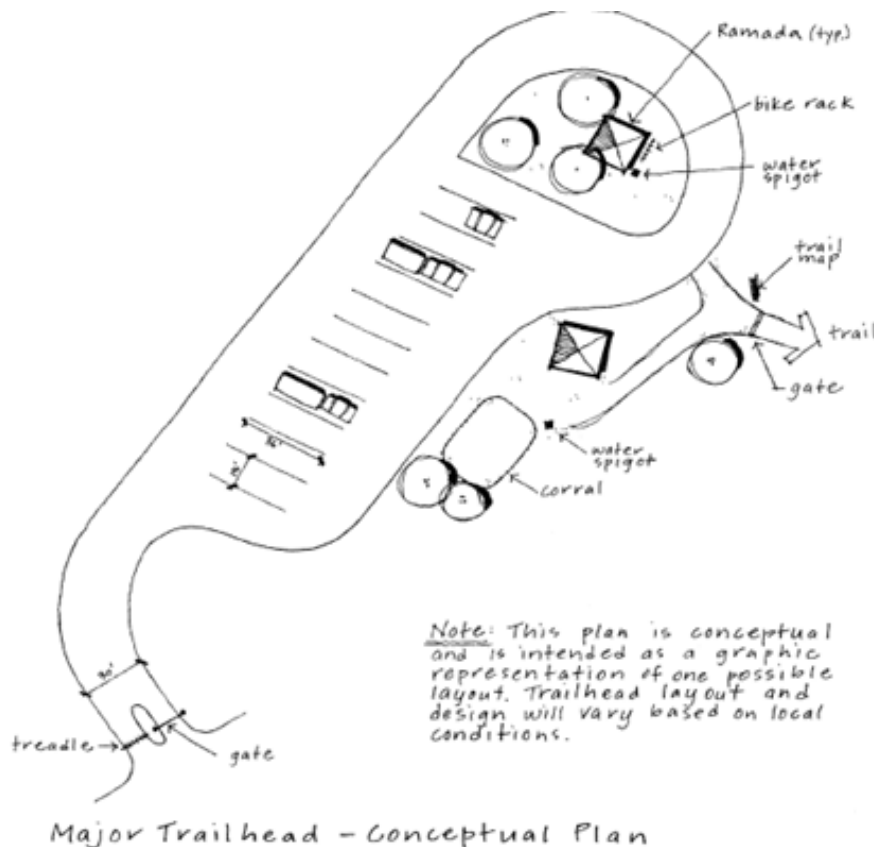

FIGURE 8-3.17 TRAIL ACCESS FACILITY CONCEPT

TRAIL SIGNS AND MARKERS

8-3.500

SIGN LOCATIONS

8-3.501

The proper location of signage is important in maintaining the safety of trail users, preserving the natural environment and promoting the presence of the trail. The number and location of signs should be carefully considered, as a lack of signage or poorly located signs can create hazardous situations for trail users. An overabundance of signs can also detract from the aesthetics of the trail and decrease the quality of the trail users' experience.

Trail signs are typically located at trail intersections, locations where trails cross roadways and any other areas where it may be difficult to follow the route of the trail. Trail signs should be placed 1.5 feet to 3 feet from the edge of the trail.

SIGN SPECIFICATIONS

8-3.502

This standard applies specifically to trails outside the McDowell Sonoran Preserve, refer to [city standard details](#).

A. Sign Specifications

1. Blanks

Sign blanks must be 0.080-gauge aluminum. Thicker, 0.125-gauge aluminum should be used for signs prone to vandalism, such as the "No Motorized Vehicle" signs. Blanks must be covered with reflective sheeting of street

transportation quality vinyl. There must be 2, predrilled, 3/8-inch holes. The holes must be centered horizontally with the center of each hole being ½ inch from the top and bottom edges. Corners must be rounded with a 1 inch to 1½ inch radius, depending on the size of the sign.

2. Lettering
3. Font must be Garamond or similar style.
Point size should be relative to the size of the sign.
4. Colors
Background must be dark brown with reflective white lettering and symbols. There must be a ¼ inch to ½ inch, white reflective border. For regulatory signs such as the “No Motorized Vehicle” sign, there shall be a white reflective background with red lettering.
5. Sign Mounting Hardware
3/8-inch, vandal resistant, steel drive rivets.

B. Post Specification

Posts shall be constructed of 1-¾ inches x 1-¾ inches, 12-gauge, square steel tubing with 7/16-inch, pre-punched knockouts on 1-inch centers. Post lengths must be 6 feet. All steel posts shall be powder coated with color to match natural rust as closely as possible. The trails planner must approve color samples prior to fabrication.

C. Sleeve and Anchor Specifications

Sleeves and anchors shall be used in locations where it is possible for a vehicle to come into contact with the signpost, such as adjacent to a street. The use of the sleeve and anchor promote easy breaking-away of the sign post in the event of a collision and increase the ease at which the sign can be replaced.

1. Anchors
Anchors shall be 2 inches x 2 inches x 30 inches; 12-gauge galvanized square tubing with 7/16-inch, pre-punched knockouts on 1-inch centers.
2. Sleeves
Sleeves shall be 2-¼ inches x 2-¼ inches x 12 inches, 12-gauge, galvanized square tubing, with 7/16-inch, pre-punched knockouts on 1-inch centers.
3. Anchor Assembly Hardware
3/8-inch, vandal resistant, steel drive rivets.
4. Telescoping Properties
The finish post, anchor and sleeve must be straight with a smooth uniform finish to allow each component to telescope with each consecutive larger or smaller piece.

INSTALLATION

Signposts adjacent to streets are to be installed according to COS Standard Detail No. 2131 and 2683.

In non-roadside locations the signpost can be mounted directly into concrete. The finished height of the post should be 5.5 feet.

Various combinations of signs can be mounted on a single post to address the management needs of the area.

8-3.503

All signs are to be mounted to the posts with 3/8-inch, vandal resistant, steel drive rivets, refer to Figure 8-3.19.

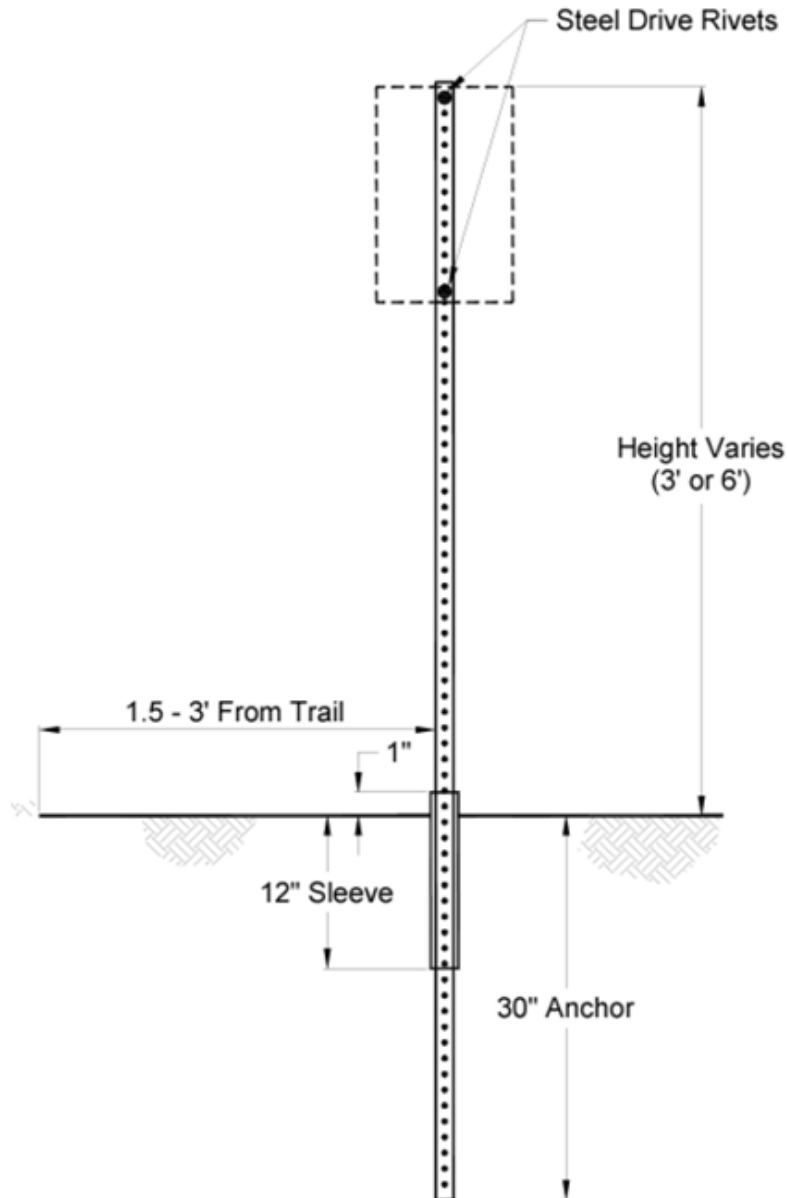

FIGURE 8-3.19 TRAIL SIGN INSTALLATION

DEVELOPER PROVIDED STANDARD

Developers may provide their own signage consistent in color and theme with the surrounding development. At a minimum, these signs must be designed according to COS Standard Detail no. 2684. The sign must accommodate the triangular "Trail Courtesy" graphic, the "City of Scottsdale Trail System" logo, and the standard hiker, equestrian and mountain bicycle icons. These required signs may be installed on the same post as developer-provided signs, or the graphics may be incorporated directly into the developer-provided sign.

8-3.504

TRAIL MAINTENANCE

8-3.600

A. Slough and Berm Removal

Slough (pronounced “sluff”) is material that has moved downhill from the backslope and been deposited along the uphill edge of the tread. This process causes trail users to travel along the outside edge of the trail. The tread eventually narrows and moves downhill from its original location resulting in an unsafe situation. The slough must be removed to reestablish the proper backslope. The excess material may be used to fill holes in the trail tread and re-establish the outslope, or to build up the downhill side of waterbars.

Berm is soil that has built up on the downhill edge of the trail tread. Berm prevents water from flowing off the side of the trail and allows water to channel down the trail causing erosion. A berm may also cause nuisance water to pool on the trail surface resulting in soil saturation. Saturated soil is damaged easily and forces trail users to detour around the area causing the trail to widen. Berms should never be constructed intentionally and should be eliminated whenever present. Refer to Figure 8-3.20 on the following page.

Before Reconstruction

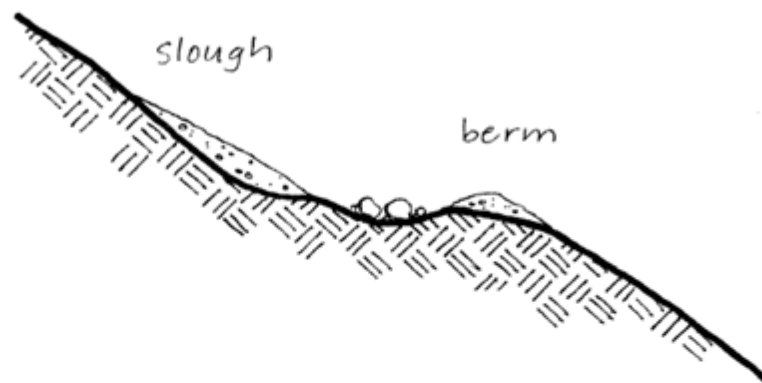

After Reconstruction

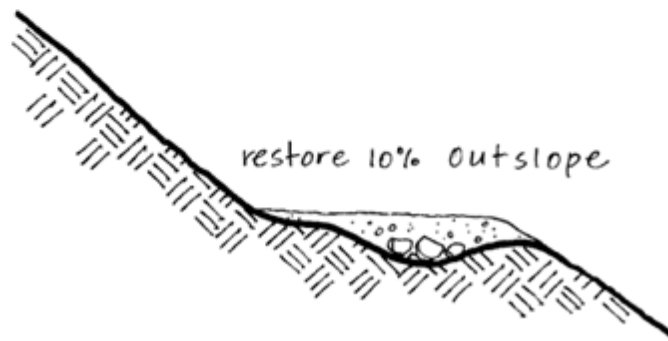

FIGURE 8-3.20 SLOUGH AND BERM REMOVAL

B. Vegetation Clearance Maintenance

All plants encroaching on the vegetation clearance limits for the trail classification must be cut back. Branches should be cut close to the main stem without cutting into the branch collar. Plants being removed must be cut flush with the ground and stumps must be removed to prevent safety hazards. All plants growing within the trail tread must be grubbed out.

Trails within landscaped areas may be sprayed with herbicide. All removed plant material must be scattered in a location not visible from the trail.

C. Tread Maintenance

In addition to slough and berm removal, the remaining trail tread should be restored to its original design condition. All loose rocks, rock points, stumps and roots protruding from the trail surface should be removed. All holes should be filled to create a smooth, obstacle-free trail tread. Maintaining a proper outslope is critical to the long-term condition of the trail.

D. Drainage Maintenance

Special attention should be directed to the maintenance of drainage structures. These structures are extremely important in protecting the trail from erosion. If

they are not maintained properly, the trail will be prone to erosion and may become unsafe for public use and require extensive amounts of labor to repair. All repairs to drainage structures must restore them to their original standard construction specifications.

E. Special Structure Maintenance

Structures such as waterbars, culverts, switchbacks, retaining walls, desert wash crossings, overpasses and bridges, etc. are rather expensive and labor intensive to construct. Proper maintenance will prolong the life of the structures and help prevent safety hazards. Structures should be inspected annually, and maintenance performed as needed. All repairs to special structures must restore them to their original standard construction specifications.

F. Sign Maintenance

Sign maintenance includes replacing missing or damaged signs and assuring the accuracy of the information on the signs, as conditions may change over time. All signs that are damaged, weathered, or for any other reason do not serve their intended purpose should be repaired or replaced according to the sign standards described in this manual.

Chapter 9

PUBLIC WORKS & FACILITIES

9

This chapter provides requirements for preparing improvement and facilities construction plans and information for developing construction bid documents for submittal to Capital Project Management (CPM). It also specifies various building standards for City of Scottsdale (city) facilities.

9-1 INFRASTRUCTURE PLAN REQUIREMENTS

9-2 FACILITIES PLAN REQUIREMENTS

9-3 CONSTRUCTION BID DOCUMENTS

Section 9-1

INFRASTRUCTURE PLAN REQUIREMENTS

9-1

This section specifies the submittal and review process and requirements for public infrastructure projects, including guidance for preparing plan, profile and detail sheets.

GENERAL INFORMATION

9-1.000

A. Standard Specifications and Details

The following publications or their current revisions, as adopted by the city, are to be used in conjunction with the infrastructure design criteria in this manual:

1. [Maricopa Association of Governments \(MAG\) Uniform Standard Specifications and Details – MAG.](#)
2. [COS MAG Supplemental Specifications and Details](#)
3. [Standard Specifications for Road and Bridge Construction – Arizona Department of Transportation \(ADOT\).](#)
4. [ADOT Standard Drawings.](#)
5. Other governmental/utility agency specifications and details as specified by city staff.

B. Design Policies and Guidelines

The city's design policies and guidelines are based on the following:

1. [Project stipulations](#) from the city's Development Review Board (DRB).
2. [A Policy on Geometric Design of Highways and Streets – American Association of State Highway and Transportation Officials \(AASHTO\).](#)
3. [Roadside Design Guide – AASHTO.](#)
4. [Manual on Uniform Traffic Control Devices \(MUTCD\) – Federal Highway Administration \(FHWA\).](#)
5. [Public Improvement Project Guide – Arizona Utility Coordination Committee](#)
6. [American Society for Testing Materials \(ASTM\)/AASHTO Standard Specifications.](#)
7. [United States Access Board Proposed Guidelines for Pedestrian Facilities in the Public Right-of-Way](#)
8. Other design standards, policies and guides as specified by city staff.

SUBMITTAL REQUIREMENTS

9-1.100

Refer to Appendix 9-1A for Capital Projects Plan Review Process.

Infrastructure Plan submittals must comply with the following standards:

- A. Prepare plans on standard 'ANSI D-size' 22-inch x 34-inch sheets and clearly reproduce them on print paper in a black line format. 24-inch x 36 inch may be used if first approved by Capital Project Management (CPM) staff.
- B. [CAD files](#) containing cover sheet, border, plan & profile and general notes are available in MicroStation or AutoCAD format for the Consultant's use.
- C. The consultant shall be responsible for the completion of the drawings as applicable to the project.
- D. Place a standard city title block in the lower right-hand corner of each sheet, except the cover sheet. The Consultants company's identification should be in the upper right-hand corner of the sheet
- E. All lettering, numbering, patterning and line work must be uniform and legible. Reproductions of drawings must be legible when reduced to 1/2 scale.

- F. On all sheets that have maps or plans, North shall be oriented to the top or right side of the sheet or to the right. Show a North arrow and bar scale on each sheet. Project stationing shall increase from left to right on the sheet.
- G. Keynote all construction notes. Group construction keynote referencing to a specific symbol (square symbols designate demolition and removals, diamond symbols designate relocations and circular shapes for construction items). Number notes uniquely such that one number represents a specific note that only occurs on the applicable plan sheets. Each construction note should be circumscribed by the appropriate symbol.
- H. All projects must comply with Section 404 of the Federal Clean Water Act. Before the city may issue development permits for a project, this 404 Certification Form must be completed and submitted with improvement plans to the CPM Design and Plan Review staff. The Section 404 Certification Form is available on the City of Scottsdale (COS) website. Consultants are advised to apply to the US Army Corps of Engineers (USACE) as early as possible for a Section 404 permit and allow for the necessary processing time to prevent delays in obtaining development permits from the city.
- I. All projects must comply with the Scottsdale's Archaeological Resources Ordinance No. 3243. Refer to the City of Scottsdale (COS) website for Archaeological Resources and obtain copy of ordinance. To help identify, preserve and protect archaeological sites, an archaeological survey and report by a qualified archaeologist is required to be submitted for all public and private developments in Scottsdale. A qualified archaeologist is an individual or firm meeting the Arizona State Museum standards and professional qualifications for an archaeologist. Please contact City Archaeologist, Project Manager or Project Coordinator for more information on archaeology requirements, including which projects may be exempt from requiring the survey and report.
- J. All projects submitted for review and/or further processing shall be complete and consist of plans, specifications, estimate of probable cost, bid schedule, structural calculations, geotechnical report, drainage report, native plant information and other documentation as required for that project.
- K. The Consultant responsible for the design must label all plans and documents submitted for review and mark them with the following: "For Review Purposes, Not to Be Used for Bidding or Construction" and provide the percentage of completion on the documents.
- L. For formal plan review submittal, the Consultant may submit sealed documents electronically in Portable Document Format (PDF) or by paper as directed by the Project Manager. If submitting electronically refer to Section 1-3.200 for additional information. If submitting paper plans, the Consultant shall submit a minimum of 4 full size sets of plans, 2 sets of specifications and 1 set of structural calculations, drainage calculations and Geotechnical report when applicable. In addition, the Consultant will provide additional plans, specifications and other documentation as required for internal user group review purposes. All plans and documents are to be submitted to the city through CPM.
- M. Upon completion of the formal plan review process, provide an electronic copy of the signed and sealed final plans, specifications, estimate of probable cost and bid

schedule in both Computer Aided Drafting/Design (CAD) (preferably MicroStation) and PDF. The Consultant shall provide and 11x17 half size scaled PDF and a full size scaled PDF. In addition, provide the specifications, estimate of probable cost and bid schedule in Microsoft Word and Microsoft Excel formats respectively. All resubmittals must include the "Attachment A" or an equivalent form stating the corrective action taken on all review comments, see Appendix 9-1B.

- N. Any facilities portion of an Infrastructure project must comply with Section 9-2.
- O. All projects with landscape areas in public rights-of-ways and medians shall have landscape maintenance/signature block (Figure 1-3.7) contained on the coversheet and/or landscape plans.

PLAN SHEET NUMBERING AND SEQUENCING

9-1.200

Sheets shall be identified by design discipline as designated below and consecutively whole numbered within each discipline. Additionally, final consecutive numbering of the entire set of plans shall be provided on each sheet.

The sheet numbering prefixes shown in Figure 9-1.1 below are commonly used. The consultant shall review the sheet sequencing and/or intended numbering with the city's project manager.

PLAN SHEET NUMBERING AND SEQUENCING		
Plan Sheet Prefixes:		
G = General		ITS = Intelligent Transportation System
D = Detail		L = Landscape
P = Paving		I = Irrigation
SD = Storm Drain		S = Structural
SS = Sanitary Sewer		U = Utility
W = Water		RW = Rights-of-Way
TS = Traffic Signalization, Signing, Markings		
Plan Sheets Shall be Sequenced as Follows		
1	G1	City cover sheet
2	G2	Notes, legend and key map sheet
3	G3	Quantity summary sheet
4	D1	Detail Sheets
5	P1	Paving plans, profiles
6	SD1	Storm drain plans, profiles and details
7	SD...	Profiles for catch basins and connecting pipe
8	SS1...	Sanitary sewer plans, profiles and details
9	W1...	Water line plans, profiles and details
10	TS1...	Traffic signal plans, schedules and details, traffic signing (TS), pavement markings
11	ITS1...	Intelligent Transportation System plans, profiles and details
12	L1...	Landscaping plans, notes, legend, abbreviation and detail sheets

NOTES, LEGEND AND KEY MAP SHEETS

9-1.302

- A. Key Map - Show all intersections, rights-of-way and key to all plans with stations.
- B. Legend of symbols used for existing and design elements.
- C. List of abbreviations used in plan set (other than as shown in the MAG Specifications).
- D. Include the City of Scottsdale General Construction Notes for Capital Projects; refer to Figure 9-1.3 below and Figure 9-1.4. Additional notes may be added as needed

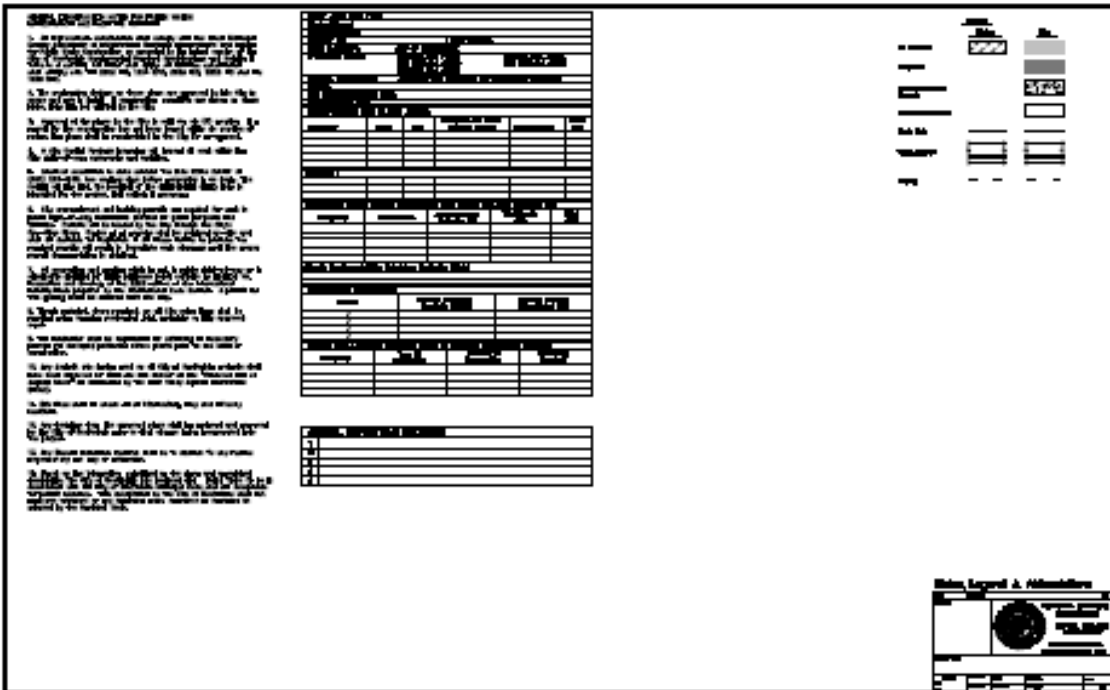

FIGURE 9-1.3 NOTES SHEET

GENERAL CONSTRUCTION NOTES FOR CAPITAL PROJECTS

- A. All improvement construction shall comply with the latest Maricopa County Association of Governments Standard Specifications and Details for Public Works Construction as amended by the latest version of the City of Scottsdale Supplemental Standard Specifications and Details and City of Scottsdale's Design Standards & Policies Manual (DSPM). If there is a conflict, the latter shall apply. All facilities construction shall comply with the latest building codes as amended and adopted by the city.
- B. The engineering designs on these plans are approved by the city in scope and not in detail. If construction quantities are shown on these plans, they are not verified by the city.
- C. Based on the information submitted on the plans and associated documents, the city has reviewed and found them to be in accordance with the Scottsdale Revised Code (SRC) and are acceptable for permit issuance. This acceptance by the city does not authorize violations of any applicable code, ordinance or standard as adopted by the SRC.

GENERAL CONSTRUCTION NOTES FOR CAPITAL PROJECTS

- D. Approval of the plans by the city is valid for six months. If a permit for the construction has not been issued within six months of review, the plans shall be resubmitted to the city for reapproval.
- E. Any deviation from the approved plans shall be reviewed and approved by the city prior to that change being incorporated into the project.
- F. A City Capital Projects Inspector will inspect all work within the city rights-of-way, easements and facilities.
- G. Any Special Inspection required shall be in addition to any routine inspection by the City.
- H. Private improvements in the right of way and building permits are required for work in public rights-of-way, easements granted for public purposes and facilities. Permits will be issued by the city through the city's One Stop Shop. Copies of all permits shall be retained on-site and shall be available for inspection at all times. Failure to produce the required permits will result in immediate work stoppage until the proper permit documentation is obtained.
- I. The contractor shall be responsible for obtaining all necessary permits for salvaging protected native plants prior to the start of construction.
- J. Wherever excavation is done contact the Blue Stake Center at (602) 263-1100 two working days before excavation is to begin. The Center will see that the location of the underground utility lines is identified for the project.
- K. All excavation and grading which is not in public rights-of-way or in easements granted for public purposes must conform to Section 1803 and Appendix J of the latest International Building Code prepared by the International Code Council. A permit for this grading must be secured from the City.
- L. Thrust restraint, where required, on all city water lines shall be provided using Megalug mechanical joint restraints or City-approved equal.
- M. Any asphalt mix design used on city projects shall have been approved for that use per DSPM Section 5-10 and appear on the "Approved List of Asphalt Mixes" as distributed by the East Valley Asphalt Committee (EVAC).
- N. The Contractor shall be responsible to remove and replace, at no additional cost to the City, all pavement, sidewalk, curb and gutter, drainage structures, etc. outside the pay limit that are damaged due to their activities on the project. This includes, but is not limited to, the removal and replacement of newly cracked roadway infrastructure, the removal and replacement of existing cracked roadway infrastructure where the cracks have been enlarged due to the Contractor's operations, the removal and replacement of deformed roadway infrastructure. All sawcuts used for the removal of these items shall be perpendicular and parallel to the centerline controlling that item, or at the direction of the city's Capital Projects Inspector.

GENERAL CONSTRUCTION NOTES FOR CAPITAL PROJECTS

- o. All Capital Improvement Projects shall meet the procedures and standards for the use of temporary/security fencing around the perimeter of construction sites, as defined in the city's Zoning Ordinance, Article VII.

FIGURE 9-1.4 GENERAL CONSTRUCTION NOTES FOR PUBLIC WORKS IMPROVEMENTS AND FACILITIES PROJECTS

QUANTITY SUMMARY SHEET

9-1.303

The sequence number preceding the bid item should correspond to the construction note number on the plan sheets; refer to Figure 9-1.5 below.

ITEM NO.	DESCRIPTION	UNIT	P-1 P-2 P-3 P-4				TOTAL
			QTY	QTY	QTY	QTY	
01	REMOVE 4" AC (A-10)	SY	200	200	200	215	700
02	REMOVE CURB & GUTTER, INCL	LN	400	400	400	400	8,000
03	REMOVE SIDEWALK, INCL 200	LF	200	200	200	200	2,000
04	REMOVE AC PAVEMENT	SY	30	30	30	30	120
05	REMOVE CURB & GUTTER	LN	200	200	200	200	400
TOTAL							

FIGURE 9-1.5 QUANTITY SUMMARY SHEET

PAVING PLAN, PROFILE AND DETAIL SHEETS

9-1.400

SHEET FORMAT

9-1.401

- A. Single plan and profile sheet, scale: 1 inch = 20 feet and not to exceed 500 feet per sheet; separate profiles for each curb and gutter and crown line at 1 inch = 2 feet vertical scale and 1 inch = 20 feet horizontal, using 3-inch separation between profiles.
- B. Removal, construction and other notes shall be categorically and numerically referenced and listed on the right-hand side of sheet. Use the same number for like work on all sheets including the quantity summary sheet. Categorize notes to type of operation, such as demolition/removal notes are first, followed by construction notes, relocation notes, sheet notes and sheet cross-reference notes. Quantities shall be shown within each construction note and duplicated to the quantity

summary sheets. A sample plan & profile sheet is available on the COS website in MicroStation and AutoCAD format for the Consultant's use.

- C. In match lines, portions of the same street are not to be repeated on separate sheets. Match lines shall show stationing and adjacent sheet number.
- D. Intersections shall not be cut by match lines and shall be complete from beginning of curb return (BCR) to end of curb return (ECR) on same sheet. When intersecting streets are to be improved beyond ends of curb returns, additional plan and profile sheets should be used to detail the intersecting street. The intersections at the beginning and end of the project shall be fully shown.

HORIZONTAL GEOMETRICS

9-1.402

- A. City major streets are typically centered along section lines, from section corner to section corner. Bearings need to be shown on plans; and all bearings of intersecting streets must be shown. All section corners, tangent points, Point of Intersection (PI) of curvilinear sections, beginning and ending taper points and monument lines of all intersecting streets shall be labeled and stationed. Survey markers shall be installed per applicable MAG & COS Standard Details.
- B. Show centerline stationing on plan and profile. Stationing numbers should be chosen to avoid "negative" stationing. The project need not start with 0+00. On curved sections the stationing should be along the centerline of the curve and not the tangent lines.
- C. Show curve data on the same sheet as the curve. Stationing shall run from South-to-North and from West-to-East.
- D. On streets that are not centered on the monument line, the stationing shall be along the construction centerline, which shall also be the proposed crown line, unless superelevation or other conditions dictate otherwise. On such streets, the rights-of-way shall be measured from the monument line. The offset between the monument line and construction centerline shall be shown and all offsets shown for new construction shall be from the construction centerline.
- E. Design on intersecting streets shall be done in accordance with the city furnished geometrics and guides, refer to Section 5-3.000. Care must be taken to ensure a smooth grade in all directions through intersections. Special design work sheets are required to show profiles on the intersecting street to ensure smooth grades in both directions. These work sheets are to be included with the grade and alignment submittals, refer to the following figure, Figure 9-1.6.

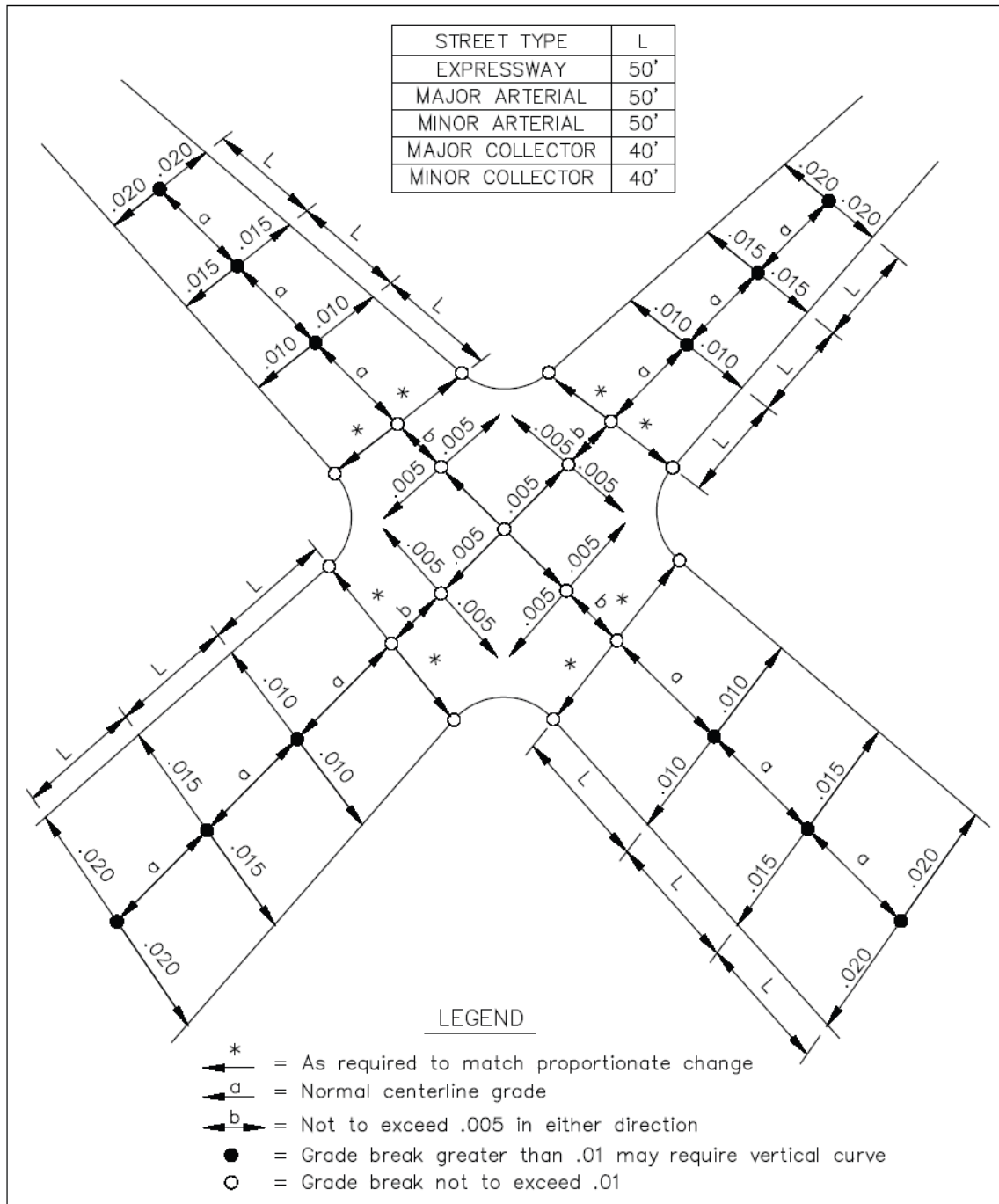

FIGURE 9-1.6 INTERSECTION CROSS-SLOPES AND CROWN RUN-OFF

- F. All curb radii shall be dimensioned on the plans to back of curb, Ramp Control Points, as per COS Standard Detail No. 2232 (for new construction) or 2233 (for retrofit construction), shall be clearly located and shown on the plans.
- G. On all existing roadways and intersecting streets, the plans shall show dimensions from monument line to rights-of-way and to existing back-of-curb. Existing medians, sidewalks, curb ramps, etc. will be clearly dimensioned and labeled.
- H. All new pavements should be fully dimensioned to the edge of pavement or back-of-curb and tied to horizontal control lines.

TOPOGRAPHY AND NOTATION

- A. Show all subdivision names, block numbers, lot numbers, property splits, lot dimensions, addresses, names of major businesses, schools, fire stations and other public facilities.
- B. Show final rights-of-way as a heavy weight line. Show original rights-of-way, where it differs from the new rights-of-way line, with a lighter weight line.
- C. Show all existing alleys and easements with proper designations and dimensioning. Show all new easements required for the project, including temporary or permanent.
- D. Show all underground utilities and appurtenances and their distances from the monument line and label size, type of material and type of utility. Utilities that are abandoned, or to be abandoned or removed should be indicated. Any utilities to be constructed prior to the project should be shown and so indicated. Underground electrical lines shall be denoted as direct burial cable or conduit-enclosed cable.
- E. Show all buried fuel tanks. When the new rights-of-way is in an area where such tanks may exist, a special effort should be made to check for the possibility of their existence.
- F. Show existing underground concrete pavements. Core borings should be utilized to determine the existence of such pavements when authorized by the city.
- G. Show existing site conditions and topography to at least 10 feet beyond the new rights-of-way line or any required easements. Use standard MAG symbols where applicable. Show all information for buildings, canopies, asphalt aprons and overhangs within 30 feet of the new rights-of-way. Existing site information should be screened approximately 40 to 60 percent, to the satisfaction of CPM plan review.
- H. Show all signs within the new rights-of-way and 20 feet beyond the rights-of-way. Electric signs shall be so noted and their source whether overhead or underground identified.
- I. Show diameter and variety of trees and shrubs within 30 feet of the new rights-of-way and within temporary construction easements. The city will determine the disposition of all trees and shrubs. If slight changes in alignment could be made to save valuable trees or the sidewalk could be realigned by acquisition of additional rights-of-way, it should be brought to the attention of the city's project manager at the earliest time possible.
- J. Show all utility poles. Differentiate between power poles with street lights and those without. Also show all traffic signal poles and their appurtenances.
- K. Show all subdivision entrance structures and indicate any utility connections. When these interfere with new construction they should be relocated or reconstructed. At times it may be necessary to obtain rights-of-way for these structures.
- L. As-built drawings or sufficient elevations must be obtained to indicate the direction of surface flow on all intersecting streets, frontage roads and parking lots. The direction is to be shown by a small arrow.

- M. Where certain items such as monuments, water valves, water meters (sizes if relocation is indicated) etc., are shown on city utility maps or record drawings but are not located, they should be shown and labeled “not found” on the plans.
- N. Show all existing irrigation systems. Where new construction requires alterations, these irrigation systems must be put back in operation by the contractor and shall be so noted on the paving plan sheets (or landscape plans).
- O. Where new rights-of-way are required, the consultant must investigate if any disconnected water or sewer connections (stub-outs) are completed to the old rights-of-way line only. Where this occurs, show the service connection (size and material) to be extended to the new rights-of-way line. Galvanized services are to be replaced in their entirety. The city will furnish a new meter if the old meter is faulty.
- P. Show all existing safety curbs. Call for relocation of existing safety curbs and the addition of new safety curbs where required.

PROFILES AND GRADES

9-1.404

- A. Construction benchmarks shall be a maximum of 1,000 feet apart and each sheet shall refer to the nearest benchmark. All benchmarks must be based on the [COS datum](#) and at least 2 benchmarks on a project shall be existing city monuments.
- B. The proposed construction centerline profile shall show the profile of the existing surface at the construction centerline. The proposed curb and gutter profiles shall also show the existing surface line at the location of the new curb line. If the proposed curb and gutter are adjacent to the existing curb of a frontage road, the existing surface line shall be omitted and the top of the existing curb of the frontage road shall be shown.
- C. Top of embankments at ditches and bottom of ditches shall not be shown to express existing surface lines. They may be shown in addition to existing surface lines if properly labeled.
- D. Existing ground elevations along the rights-of-way lines should be indicated by tick marks along the left and right gutter profile lines at approximately 100-foot intervals.
- E. If the ditch bottom or banks occur at the property line, the elevation to be shown in the profile for the property line shall be taken beyond the ditch on “average” ground and the offset noted.
- F. Existing roadway profiles shall be extended to a minimum of 300 feet past the ends of the project to assure a smooth transition between the existing and new roadway.
- G. Elevations must also be shown in the profile at all driveways, sidewalks, curb ramps and parking lots. Elevations of building floors within 30 feet of the property line shall also be shown in the profile and any other buildings that appear to be low compared to street grades. Sufficient elevations beyond the property line shall be recorded in the field notes at driveways that may require significant alterations beyond the property line.
- H. Cross section sheets shall have a scale of 1 inch = 10 feet horizontal and vertical. 1 inch = 5 feet or 1 inch = 20 feet may be used where special conditions warrant their use. Cross sections shall be plotted at 25-foot intervals depicting the proposed

street cross section, in areas where new curb and gutter is retrofitted into existing pavement and less than 1 lane of pavement adjacent to the curb is removed and replaced to insure smooth cross-sectional transitions.

- I. Sufficient elevations shall also be taken and recorded in the field notes of all parking areas; driveways and private property to be certain that the property ADA slopes and cross slopes are indicated.
- J. Elevations of existing water valve nuts shall also be shown in the profile with the appropriate symbol. It is the responsibility of the consultant to uncover these valves, obtain the elevations and replace the cover and any excavated pavement.
- K. Longitudinal and transverse grades shall be designed for proper drainage following the guidelines of COS design criteria, standards and ordinances, refer to Figure 9-1.6. Proposed curb grades shall be set to drain all paved adjacent property. Where this is not possible, catch basins may be required beyond the rights-of-way lines, but only where permanent rights-of-way or permanent drainage easements are obtained for the catch basin. In projects with flat longitudinal slopes, the grades shall be set to prevent sump conditions that may flood private property during large storms. Chapter 37 of the [SRC](#) stipulates specific requirements for depth of water in roadways and minimum numbers of clear lanes during storm runoff. The consultant shall obtain and design to these requirements.
- L. Where possible, grades should be set to reduce high crowns where they exist. This will assist the flow of floodwaters and prevent backup into houses. Care should be used in lowering existing streets since excavation to construct pavements may uncover existing utilities and possibly change drainage patterns.
- M. Any streets with horizontal curves sufficient to require superelevation should be designed in accordance with AASHTO guidelines. The consultant is advised to discuss this subject with the city prior to design of superelevation. Limitations on the use of superelevations are described in COS design criteria and standards.

STORMDRAIN PLAN, PROFILE AND DETAILS SHEET

9-1.405

A. **Storm Drain (SD) Design Sheet**

Alternate SD piping materials should be summarized on a single sheet and shall reference types of materials, design dimensions, material strengths, bedding conditions and soils information, etc. Refer to Figure 9-1.7 below for an example.

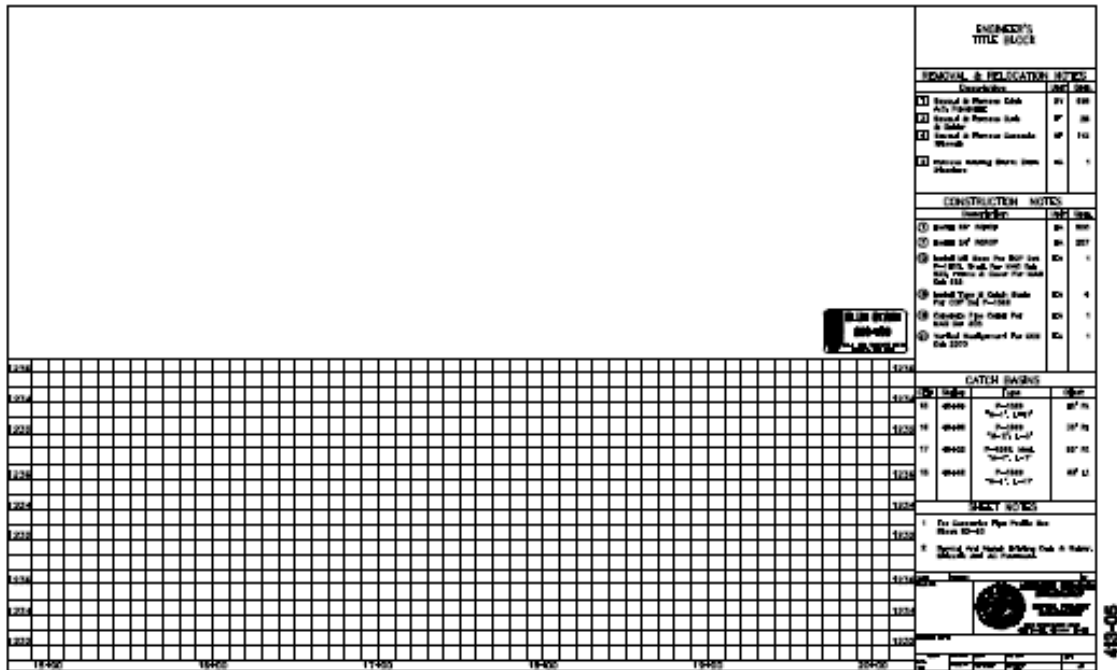

FIGURE 9-1.7 SD PLAN AND PROFILE SHEET

B. Sheet Orientation

Sheets are to be oriented and have the same horizontal and vertical scale as the paving plans.

C. Topography and Notation

1. SD drawings shall show all the existing utilities and any new utilities proposed within a minimum of 30 feet of the centerline of the SD. It shall also show other existing topography as shown on the paving plans (or to within 30 feet of the drain centerline if not located within right-of-way) that is pertinent to drainage.
2. These drawings shall show, in plan, all proposed SD pipe, manholes, catch basins, connector pipes, pipe collars and other drainage appurtenances. These items should be listed and referenced to standard details. The plan sheet quantity should be noted in the right-hand column of the plan sheet. Add reference to sheets where details or sections are shown.
3. SD main lines, connector pipe and catch basins shall also be shown, in plan, on the paving sheets. A reference to the appropriate sheet number for the SD plans shall be shown on each paving plan sheet.
4. If the SD main exists and no separate SD plans are required, the catch basins and their lines shall be called out on the paving plans. Details of catch basin with connecting pipes shall be included with paving details.
5. Conflicts with existing utilities shall be noted in both plan and profile.

D. Horizontal Alignment

The most satisfactory alignment is determined by the location of existing facilities. Desired location is near the centerline of the existing or proposed street. Existing utilities crossed under at angle less than 45 degrees may require special design considerations and should be avoided. Location of the SD should consider the

interference of water main thrust blocks and the need to provide maintenance on either system.

E. Profiles and Grades

1. An overall system profile sheet shall be included with the set and shall show the pipe sizes, grades and locations of manholes and lateral connections. The hydraulic grade lines shall be shown along with the existing/proposed finish grade over the pipe. Crossing utilities including SS lines, water lines greater than 12 inches, SD lines, and major electric and telephone feeds shall be indicated at their proper locations.
2. The SD pipe and manholes shall be shown in profile. The pipe size and the slope to 4 significant figures shall also be shown in the profile. The existing ground over the proposed pipe and the proposed grade shall be shown.
3. Design of SD systems shall be per COS design criteria and standards. The Consultant shall obtain the applicable criteria and standards and arrange for a consultation with the city Floodplain Administrator prior to starting design of the SD system. This is very important since the drainage areas to be considered in the design may vary.
4. Generally, for maintenance reasons, the minimum pipe size required for the main is 24 inches and the lateral collector pipe shall be 18 inches. Smaller diameter pipes require staff approval and will be considered by the city if utility conflicts may be avoided and the pipe has sufficient capacity to carry the design flows.
5. All existing or proposed utilities crossing the new SD shall be shown in the profile at their proper as-built, field-verified, or potholed locations.
6. Prefabricated fittings shall be used for all new horizontal or vertical bends where feasible. Locations of bends or fittings shall be called out on plan and profile.

PROFILES FOR CATCH BASINS AND CONNECTING PIPE

9-1.406

A. Sheet Orientation

1. All these sheets are to be cross-section sheets.
2. Sheets should have the appropriate COS title blocks.
3. Catch basins and their connecting lines shall be drawn facing North or facing East.

B. Profiles and Grades

1. Profiles should show the correct top of curb elevation at the catch basin and a cross section of the proposed catch basin. Invert elevations of the connector pipe shall be shown at the outlet from the catch basin and the inlet to the storm sewer as well as any grade breaks. Show the size of the pipe and the percent of slope (to 4 significant digits). Also, show the catch basin type and size, the station and offset, and a cross reference to the SD plan and profile sheet where the catch basin is shown.
2. All existing utilities crossing the proposed pipe shall be shown at their proper location and elevation. Use as-built drawings to obtain the correct elevation. When elevations are available from as-built plans, the elevation should be

called out on the profiles. Where no elevations are available, the utility shall be located from the best available information.

3. A note should be included on each sheet stating that the elevation is unknown, unless noted on the profile. Where elevations of existing utilities are not known, and their existence could conflict with the proposed pipe or catch basin, to determine exact elevations and horizontal locations, the consultant must coordinate digging potholes with the respective utility company.
4. Utilities located in the field shall be shown in plan and profile at their correct location and noted in profile with their exact elevation and the notation "potholed elevation".
5. Minimum vertical clearance between the proposed pipe and all existing utilities, other than Salt River Project (SRP) pipe, shall be per MAG Standard Specifications or the COS MAG Supplement. SRP requires a 2-foot horizontal clearance with underground utility lines, poles, fences, buildings, etc., and 1-foot vertical clearance with underground utilities. On special occasions they will permit 3 inches of horizontal clearance with catch basins.
6. Utilities that will require relocation shall be noted in the cross sections and shown at the existing and new locations.
7. All required pipe collars and pipe supports shall be called out on the cross section. Prefabricated tees shall be utilized whenever possible.

IRRIGATION PLAN, PROFILE, AND DETAIL SHEETS

9-1.407

A. Sheet Orientation

Sheets shall have the same orientation as the paving plan sheets.

B. Topography and Notation

Paving removal items shall be called out on the paving sheets, not on the irrigation sheets. When SRP does its own construction, removals to be done by SRP forces shall be called out on the paving sheets and it shall be noted that they will be removed by SRP. Construction items for irrigation work shall be called out on the irrigation sheets. If SRP is required to complete its own construction, the construction items shall be listed and noted as such.

C. Horizontal Alignment and Design

1. Private irrigation pipe, ditches and structures will be placed on private property using a temporary construction easement. The private irrigation pipelines may be placed under the proposed sidewalk if placing pipe on private property would result in the loss of existing trees or landscaping or cutting of planters or buildings or concrete pavement parking areas, and if there is no conflict with SRP.
2. SRP irrigation pipe may be placed under the proposed sidewalk; however, their structures are to be placed on city rights-of-way, behind the sidewalk.
3. In locating private or SRP pipe, care should be used to allow space for utility poles, streetlights, or traffic signal pole bases along the property line, and sufficient horizontal clearance between any structures and the proposed pipe.
4. The consulting engineer, at the earliest opportunity, shall notify SRP, in writing, of the project and request a design schedule and estimated design cost. A copy of this request and the proposed schedule must be sent to the city. The

consultant will provide SRP with all available information on the location of other utilities, street grades and street alignment. The consultant shall cooperate with SRP so that the final design will meet their standards and be the most economical for the city.

5. At the same time, they are submitted to the city for review, the consultant shall send a set of grade and alignment plans to SRP and request a determination of rights-of-way requirements for their facilities. It is essential to meet rights-of-way schedules that these rights-of-way requirements be submitted to the city as soon as possible.
6. A second set of grade and alignment plans shall be sent to SRP after approval by the city. Based on these plans, SRP can proceed with the design. SRP will prepare a red-line preliminary design and transmit it to the consultant. The consultant shall review the red-line preliminary design and return it, with comments, to SRP as soon as possible. SRP will then complete the final design.
7. If existing private or SRP irrigation pipes are to remain as is, the consultant shall investigate the type of pipe and its condition to ensure it is fit to remain. The consultant shall also investigate the elevation of the pipe to be sure enough cover will be provided over the pipe even during the time of construction. The consultant must meet with Salt River Valley Water Users Association (SRVWUA) to determine what requirements should be met for the project.
8. On private irrigation lines and ditches, the consultant must obtain the delivery quantities and irrigation schedule from the Water Master. The consultant shall be completely responsible for the design of private irrigation systems. The determination of rights-of-way requirements at an early date is essential in maintaining the time schedule; submit these requirements to the city as soon as possible. Hydraulic computations on private irrigation shall be furnished to the city. All work involving private or SRP irrigation shall be coordinated with the city's project manager.
9. SRP typically constructs its own facilities, therefore, the consultant shall show SRP's design on the plan of the paving sheets and properly note which work shall be done by the city's contractor and which will be done by SRP. Plans of SRP work are to be placed at the end of the construction plans for a permanent record.

D. Profiles and Grades

Profiles shown for irrigation pipes must show the proposed surface grades over the centerline of the pipe as well as the invert profile of the pipe and the top of the pipe. Top elevations must also be shown for all irrigation structures. Grades of pipe shall be established which will provide sufficient cover over the pipe as well as be hydraulically efficient.

PLAN, PROFILE AND DETAIL SHEETS

A. Sheet Orientation

Sheets shall have the same orientation as described in the paving plans section.

9-1.408

B. Topography and Notations

1. Provide the same siting information as required for the paving plan base sheets for the SS plan sheets.
2. If the sewer is in an easement outside the rights-of-way, show all existing site conditions to 30 feet minimum along each side of the pipeline.

C. Horizontal and Vertical Control

1. Establish 1 construction benchmark for every 1000 feet minimum along the alignment of the pipeline. At least 2 city benchmarks should be referenced (NAVD 88). To access the city horizontal and vertical datum manual, see <https://eservices.scottsdaleaz.gov/eservices/dmc/CoordinateSystem.aspx>. To access the city horizontal and vertical benchmarks, see <http://eservices.scottsdaleaz.gov/maps/benchmarks>
2. Stationing shall be established along the pipeline, increasing from lower to higher invert elevations, and be referenced to street centerline or monument lines at manholes or angle points where possible. Where this is not possible, the use of bearings and distances along the pipe centerline shall be utilized. The beginning and end of the SS line shall be tied to the nearest monument point.

D. Soils Testing

1. Prepare the geotechnical investigation.
2. Additionally, provide soils boring logs at a minimum spacing of 1320 feet along projects whose average trench depth exceeds 10 feet. Boring should extend to 24 inches below the proposed bottom of the trench and be of sufficient diameter to allow for laboratory testing and analysis. Locations of borings shall be identified on the plans. Soil boring logs shall be included on a geotechnical report along with a discussion of any bedding, shoring, excavating, or dewatering considerations.

E. Profiles and Grades

1. Profiles shall indicate the existing and design grade line over the pipe and shall include the "as-built," "field-verified," or "potholed" locations of all crossing utilities.
2. Vertical locations of SDs and SS should be interpolated from verifiable field elevations along accessible points. Locations of other pipes shall be taken from information on existing "as-built" drawings or actual field "pothole" datum.
3. When existing "as-built" plans of a water line greater than 12 inches diameter, a high-pressure gas line greater than 4 inches diameter, and telephone or electrical conduits do not indicate a depth of bury, the engineer must coordinate with the utility company for a "pothole" location to be provided. When existing "as-built" plans of a water line, a gas line, or telephone or electrical conduits do not indicate a depth of bury, the engineer shall coordinate with the utility company to provide a "pothole" location.
4. Identify existing utilities by name, size and type of pipe in the profile. If existing or proposed pipes are greater than 21 inches (inside) diameter, show top and bottom invert grade line and an indication of pipe wall thickness in the profile. For pipes 21 inches or smaller (inside) diameter, indicate only top and bottom invert grade.

5. Necessary water relocations shall be per [COS Standard Detail](#) No. 2370. Coordinate requirements for shut-off and air release/vacuum valving with the city Water Resources Department.
6. Show invert and rim elevations on all manholes and pipeline invert elevations on all ends of stubouts or at points of match sheet. Pipeline grades should be established to 4 decimal places.
7. Calculate invert elevations and lengths of pipe from center of manhole to center of manhole. Sections of pipe connected to manholes should be 5-foot maximum length to minimize the adverse effects of any settlement.

WATER LINE PLAN, PROFILE AND DETAIL SHEETS

9-1.409

Sheet orientation, topography and notations, horizontal and vertical control, and soils testing should be like those criteria described for the previous section "SS Plan, Profiles and Detail Sheets".

PROFILES AND GRADES

- A. Profiles are required for all waterlines.
- B. Profiles shall indicate the existing and design grade line over the pipe and shall include the "as-built," "field-verified," or "potholed" locations of all crossing utilities.
- C. Vertical locations of SDs and SS shall be interpolated from verifiable field elevations along accessible points. Locations of other pipes shall be taken from information on existing "as-built" drawings or actual field "pothole" datum.
- D. When existing "as-built" plans of a water line, a gas line, or telephone or electrical conduits do not indicate a depth of bury, the engineer shall coordinate with the utility company to provide a "pothole" location.
- E. Identify existing utilities by name, size and type of pipe in the profile.
- F. Existing water line relocations may be necessary and shall be per COS Standard Detail No. 2370. Minimum separations between water lines and electric/gas lines shall be per COS Standard Detail No. 2372.
- G. Construct all fire line services and hydrant connections with DIP.
- H. Water mains 12 inches in diameter shall have a minimum cover of 48 inches to finish grade; mains smaller than 12 inches in diameter shall have a minimum cover of 36 inches to finish grade; mains greater than 12 inches in diameter shall have a minimum cover of 60 inches to finish grade. Water mains in industrial areas or in major collectors and arterials shall have a minimum of 48 inches cover.
- I. All bends, angle points, fittings shall be stationed. On water lines, show the design top of pipe elevation. Cut stakes shall be provided for the trenching of all water lines 12 inches or more in diameter.

TRAFFIC SIGNAL PLAN, SCHEDULE, AND DETAIL SHEETS

9-1.410

A. Plan Sheet

Refer to Section 5-4 Traffic Signal Design, for specific information on plan sheet sets. Plan submittals and plan content are described in Section 5-4.200 and Section 5-4.300.

B. Notes and Schedules

Develop these as necessary to show the conductor schedules, controller and pole schedules, phasing details, etc., and general notes with cross references to items shown on the plan sheet. See Section 5-4.302 and Figure 5-4.5 for further guidance.

TRAFFIC SIGNING (TS) AND PAVEMENT MARKINGS

9-1.411

A. Sheet Format

Provide double plan at 1 inch = 40 feet scale, the same orientation as the paving plans.

B. Plans

1. Signing and striping shall conform to ADOT Specifications and Standard Drawings and the Manual of Uniform Traffic Control Devices, unless shown otherwise in COS design criteria and standards, or as directed by the Traffic Engineering Program.
2. Existing striping shall be shown and dimensioned to a minimum of 300 feet beyond where it ties into the new work. All new work shall be appropriately dimensioned from lip-of-gutter to center-of-stripe, etc. Overall dimensioning shall be provided across pavement widths and rights-of-way. Refer to Section 5-4 for a list of applicable notes to place on plans.
3. All permanent pavement striping, including crosswalks, shall be extruded 90-millimeter (mil) thermoplastic. Temporary pavement markings and island noses should be reflectorized traffic paint. Legends and arrows to conform to ADOT Specifications for high performance preformed Type 1 permanent tape and ADOT Standard Drawings.
4. Raised pavement markers are generally required for all new COS paving projects.

LANDSCAPE, LANDSCAPE IRRIGATION AND INTEGRATED SIGN PLAN

9-1.412

A. Sheet Format

Landscaping and irrigation may be combined on the same plan for simpler projects, but generally require separate plan sheets. In either case, the orientation and scale shall be the same as for paving plans, using a double plan on each sheet. The landscaping plan shall also show all street signs to avoid landscaping conflicts that interfere with street sign placement. The standards for sight lines in C.2. below shall be considered for appropriate landscaping near street signs.

B. Note and Legends Sheet

This sheet may be combined for the landscaping and irrigation plans. It shall contain general notes, landscaping notes, irrigation notes, list of plants and shrubs used (noting common and botanical names), list of irrigation components, legends of landscape and irrigation symbols, quantities, approval block, maintenance statement signature block per Figures 1-2.7 and 1-2.8, and miscellaneous details. If the project will be reviewed and approved by the DRB, the Development Review number and signature block per Chapter 1 shall be placed on the lower right-hand corner of each sheet.

C. Plan Sheets

1. Landscape plans shall show individual shrubs and trees plus types and areas of various groundcovers, including grass, decomposed granite, pavers, exposed aggregate paving, etc., with quantities shown on the right-hand column. Identify restoration work behind new sidewalks, or in other areas disturbed by construction work. Existing items to be removed or transplanted shall be shown with special attention to native plants that are required to be salvaged. The city will furnish guidance and assistance in identifying plants to be salvaged or transplanted as well as selecting types of new plants that will conform to the city landscaping policy and to the requirements of the Arizona Department of Water Resources (ADWR) for the Phoenix Active Management Area.
2. Sight lines shall be shown on the landscaping plans and shall conform to COS criteria and standards. Design consideration should be given to placement of plants, size of plants at maturity, canopy widths and general maintenance. Planting density shall not exceed tree/shrub natural growth habits. Generally, shrubs should be kept a minimum of 4 feet away from the curb or sidewalk, and when within a sight line they should not exceed a maturity height of 18 inches above the curb.
3. Trees should be located so that the mature canopy will not overhang the curb or sidewalk line. Within a sight line, trees shall have a single trunk with a clear height of 8 feet to the canopy.
4. Irrigation plans shall provide detailed design from the service side of the meter. The irrigation service and meter size will be provided and noted on the civil plans.
5. Identify the detail and dimension, or station the locations and layout of the meter, backflow preventer, control valves, main and lateral lines, pressure regulator and emitters, etc. Diagrammatic layout plans will not be accepted by the city. The consultant shall clearly indicate with stations and dimension to the back of curb or sidewalk the proposed locations of the irrigation components.
6. Valve flow rate, station number, size and description (tree, shrub, turf, etc.) shall be given for each valve.
7. Separate emitters shall be shown to each plant. Distribution tubing length shall not exceed 6 feet. Trees and shrubs are to be valved separately. Separate emitters shall be shown to each plant. Number of multi-port emitters for trees shall be per city emitter layout detail number 2641-2. Emitter flow rate shall be provided on the plans.
8. Show the electrical source plus the controller location and all wiring, including conduits and sleeves.
9. Upon request, the city will provide the consultant a listing of products that may be listed for performance and quality control. The drawings need to reference "or approved equivalent" in all cases.
10. City of Scottsdale maintained landscape and irrigation improvements shall be designed based upon city supplement to MAG specs and details, Sections 8-1 and 8-2, along with other design criteria. City landscape and irrigation details shall be provided in the plan sets.

BRIDGE AND STRUCTURAL PLANS AND DETAILS

9-1.413

At the city's option, bridges on canals may be designed as a separate contract to be bid separately from the roadway plans, since the bridge must be built during the annual canal dry-up. Bridges over washes may be included as part of the paving plans.

A. Required Sheets

The sheets required on a typical set of bridge plans, which are independent of the roadway plans, are shown in Figure 9-1.8

REQUIRED SHEETS FOR BRIDGE AND STRUCTURAL PLANS	
1.	City cover sheet with information as shown in Figure 9-1.2.
2.	Typical section sheet to show sections of roadway work included.
3.	Notes and legend sheet with information shown in Figure 9-1.3 with additional bridge and structural notes.
4.	Paving plans and profile sheet with additional information concerning bridge and structural details.
5.	Detour plan and profile, if required, showing all details required for the detour in plan and profile.
6.	Plan and profile for any water, sewer, or irrigation alterations to be included as part of the bridge contract.
7.	Bridge location plan showing the bridge in plan and profile and the bridge quantities.
8.	Soil boring log sheet showing all soils information obtained and the note concerning responsibility.
9.	Abutment Details.
10.	Pier Details.
11.	Deck Details.
12.	Miscellaneous details (approach ramps).
13.	Handrail and Guardrail Details.

FIGURE 9-1.8 REQUIRED SHEETS FOR BRIDGE AND STRUCTURAL PLANS

B. Additional Requirements

1. The consultant shall discuss the project with SRP at an early date to obtain their requirements when designing a bridge over a canal or when any SRP facilities are involved. Generally, the first step of a bridge design over an SRP canal will be to obtain a statement from SRP as to whether they consider the bridge a restriction in the canal. If they do consider it a restriction, it shall be necessary for the engineer to submit a hydraulic study to SRP to assure that construction of the new bridge or bridge widening will not adversely affect hydraulic characteristics in the canal. Upon approval of that study by SRP, the consultant shall proceed with preparation of preliminary plans. Following review and approval of such plans by the city and SRP, the consultant shall proceed to drafting final plans. Throughout all stages of project design, the consultant shall coordinate all work with SRP to minimize any possible conflicts. Bridges over SRP canal facilities must conform to prevailing SRP standards and requirements.
2. Consultant shall consider sight distance requirements when designing the roadway portion of the contract.

3. At an early date, the consultant shall coordinate with other utilities such as Qwest Communications International, Inc., SRP, APS, Southwest Gas, Cable TV, and the COS Water and Wastewater Department to identify any necessary relocations of their facilities.

RIGHT-OF-WAY (ROW) PLANS

9-1.414

A. Strip Map

Strip maps shall be at a scale (generally 1 inch = 100 feet) sufficient to differentiate the various easements, parcels and existing improvements. Format should be shown on a 24 inches x 36 inches sheet. Show each parcel abutting the project and indicate proposed and existing dimensioned rights-of-ways, easements, ownership and areas. Refer to Figure 9-1.9 below for a sample ROW Strip Map Exhibit.

1. Format: 24 inches x 36 inches per city.
2. Scale: 1 inch = 100 feet (or as required).
3. Property addresses, and occupants identified.
4. Property owners identified, including Tax Assessor's parcel numbers.
5. Existing easements and ROW identified.
6. New easements and ROW to be acquired identified.

B. Parcel Exhibits

One exhibit per parcel is required. One exhibit per ownership may be submitted with approval from the COS Right-of-Way Agent. Prepare parcel exhibit maps on individual sheets and include a legend indicating the type of acquisition. The plan view should show the parcel boundary dimensioned to section corners (non-subdivided lots), adjacent rights-of-way centerline and any on-site improvements, along with all existing and proposed easements and rights-of-ways clearly identified and dimensioned. The identification of existing rights-of-way and easements should include the appropriate county recording information. Refer to Figure 9-1.10 below for a sample Parcel Exhibit.

1. Format: 8-1/2 inches x 11 inches.
2. Title block at lower right identifying the city's project, project number, tax parcel number and the property owner(s).
3. North arrow and scale.
4. 1/4 section ties.
5. Property addresses, and occupants identified.
6. Existing easements and ROW identified.
7. New easements and ROW to be acquired identified.
8. Individual areas noted.
9. Parcels dimensioned and bearings.

C. Parcel Descriptions

The individual parcel descriptions for all new easements and/or rights-of-way shall be prepared by, or under the direct supervision of a land surveyor registered in the State of Arizona and shall be sealed by the same. All parcel descriptions shall be typed on separate 8-1/2 inches x 11 inches formats and shall be consistent with Arizona Professional Land Surveyors (APLS) standards. Refer to Figure 9-1.11 for a sample Parcel Description.

The description should be typed in single space format and double spaced between its various parts as outlined below:

1. Caption
Brief introduction stating location of parcel, portion of a subdivision, aliquot portion of sectional breakdown, township and range.
2. Body
 - a. Tie true point of beginning to an established section corner, identifying its character.
 - b. Metes and bounds courses.
 - c. Identify boundary lines of joiners, citing Maricopa County Recorder's numbers and pages.
3. Area of easement or ROW, stated to nearest square foot (sq.ft.) and 10,000th acre.

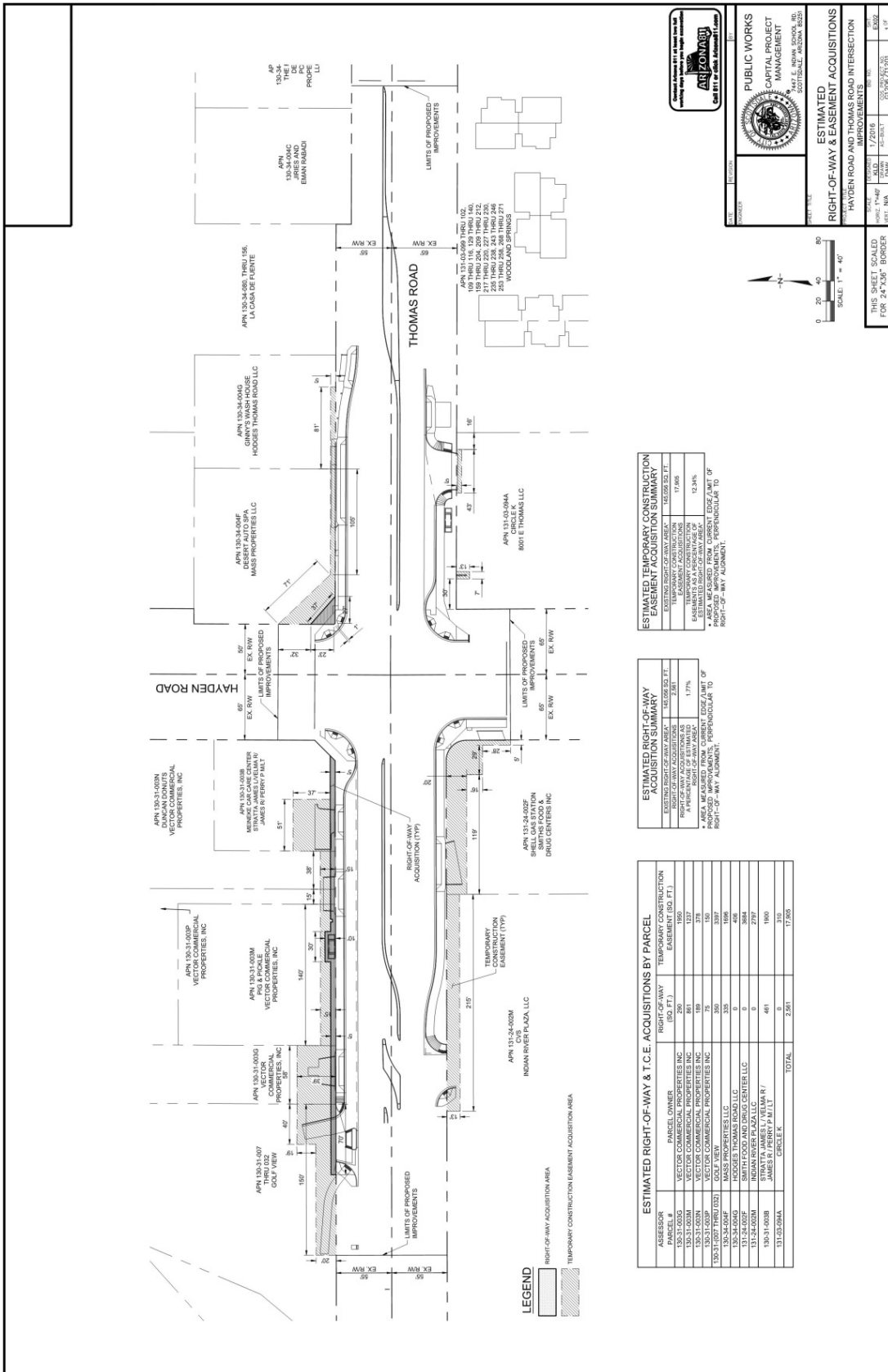

FIGURE 9-1.9 SAMPLE ROW STRIP MAP

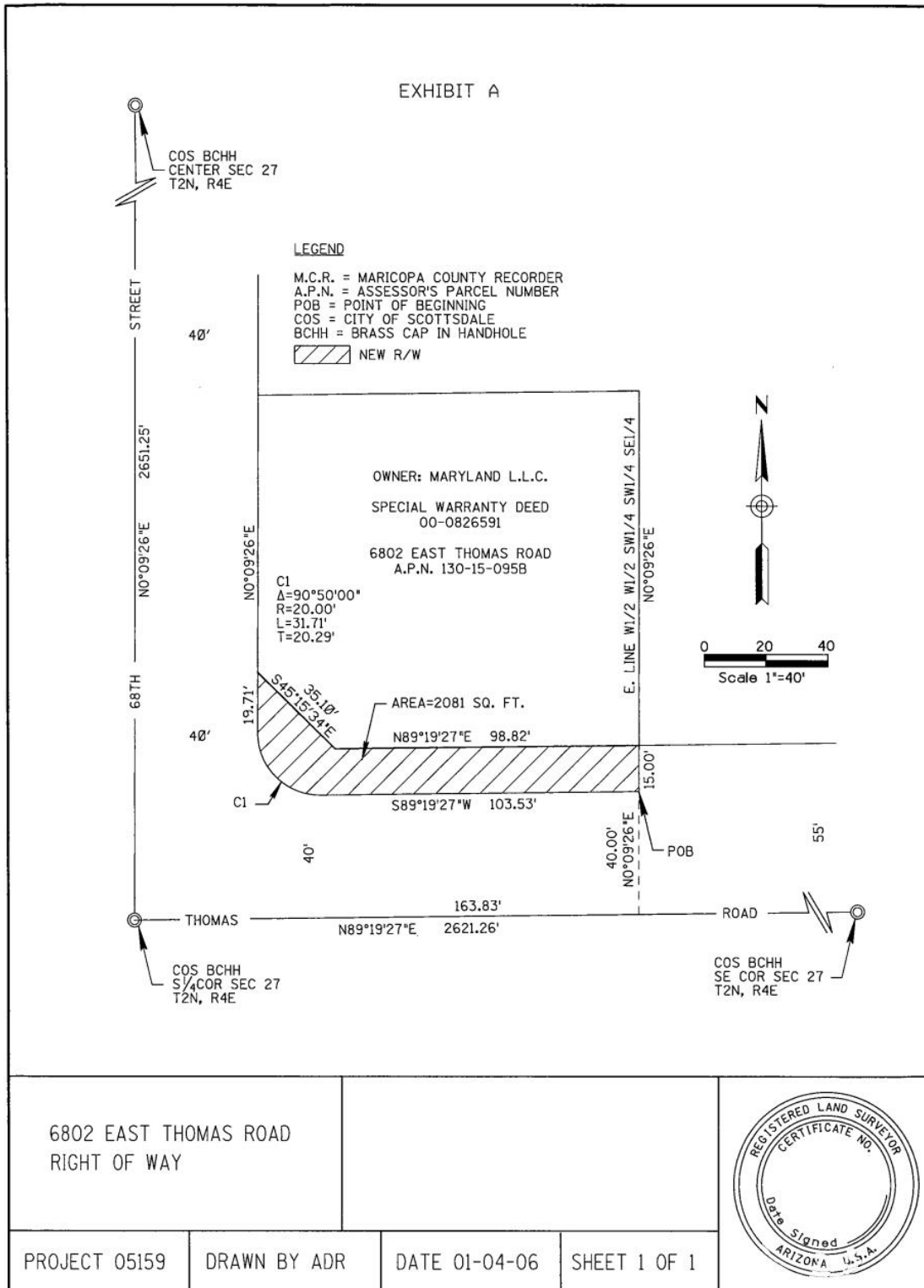

FIGURE 9-1.10 SAMPLE ROW PARCEL EXHIBIT

LEGAL DESCRIPTION

RIGHT OF WAY

6802 EAST THOMAS ROAD

A portion of the Southwest quarter of the Southeast quarter of Section 27, Township 2 North, Range 4 East of the Gila and Salt River Meridian, Maricopa County, Arizona, described as follows:

COMMENCING at the South quarter corner of said Section 27, marked with a City of Scottsdale brass cap monument, from which the Southeast corner of said Section 27, marked with a City of Scottsdale brass cap monument, lies North 89°19'27" East, 2621.26 feet;

THENCE along the South line of said Southwest quarter of the Southeast quarter, North 89°19'27" East, 163.83 feet to the East line of the West half of the West half of the Southwest quarter of the Southwest quarter of the Southeast quarter of said Section 27;

THENCE departing said South line, North 0°09'26" East along said East line, 40.00 feet to the POINT OF BEGINNING;

THENCE parallel with and 40.00 feet North of the South line of said Southeast quarter, South 89°19'27" West, 103.53 feet to the beginning of a curve concave Northeasterly, and having a radius of 20.00 feet;

THENCE Northwesterly along the arc of said curve, to the right, through a central angle of 90°50'00", an arc length of 31.71 feet to a point 40.00 feet East of the West line of said Southeast quarter;

THENCE parallel with and 40.00 feet East of the West line of said Southeast quarter, North 0°09'26" East, 19.71 feet;

THENCE South 45°15'34" East, 35.10 feet to a point 55.00 feet North of the South line of said Southeast quarter;

THENCE parallel with and 55.00 feet North of the South line of said Southeast quarter, North 89°19'27" East, 98.82 feet to a point on said East line;

THENCE South 0°09'26" West, along said East line, 15.00 feet to the POINT OF BEGINNING.

Containing 2,081 square feet, more or less.



FIGURE 9-1.11 SAMPLE ROW PARCEL DESCRIPTION (RIGHT SIDE)

CAPITAL PROJECT PLAN REVIEW PROCESS

A. Review Submittals

1. Infrastructure Projects
 - a. Concept Submittal (15%) & Preliminary Drainage Study
 - b. First Submittal (30%) (Grade, Alignment review, ROW Strip Map)
 - c. Second Submittal (60%) (Progress plans, Final ROW Exhibits & Legal Descriptions)
 - d. Third Submittal (90%) (Completed plans)
 - e. Approval Submittal (Sealed plans 100% complete, submitted to CPM & One Stop Shop)
2. Facilities Projects
 - a. Schematic/Program Submittal (15% - 30% Complete)
 - b. Design Development Submittal (60% Complete)
 - c. Pre-Construction Documents (90% Complete)
 - d. Final Construction Documents (Sealed Plans 100% complete, submitted to CPM & Once Stop Shop)

B. Develop Project Schedule

1. Establish project schedule with Project Manager.
2. Verify project submittal dates with Project Manager.
3. Include project submittal to One Stop Shop in project schedule.
4. Send updated schedule monthly to Project Manager.

C. Pre-Submittal Preparation

(prior to a scheduled project submittal)

1. Verify submittal date with Project Manager.
2. Coordinate with COS staff members involved in the review process (see below) and establish timeframes for their participation:
 - a. Designated One Stop Shop Final Plan Review staff member: for project components deviating from design criteria or General Plan.
 - b. Floodplain Administrator or designee: for preliminary drainage study compliance with floodplain management policies.
 - c. Traffic Engineering Director or designee: for approval of traffic-related deviations from Master Plan, and reviewing signalization, striping, signing and counter loop locations.
 - d. Field Services: for review and input on landscaping and irrigation systems.
 - e. Field Services: for review and input on pavement, signing and striping designs.
 - f. Facilities Maintenance, Parks Department: for review and input on all city-maintained structures and/or equipment.
 - g. Water Resources: for projects with any facilities, main transmission, supply or trunk lines.
 - h. Rights-of-Way Agents and city's appraiser: for reviewing rights-of-way submittal.
 - i. Planning: for theme districts or roadway landscaping.

D. Project Review Sequence

CAPITAL PROJECT PLAN REVIEW PROCESS

1. Prior to project submittal, Consultant shall confirm review dates with other involved COS staff, provide documents for their review, and apprise them of review completion deadline.
 2. Verify design criteria with Project Manager.
 - a. Scope of work from contract.
 - b. Minutes of meetings that contain design criteria determination.
 3. Prior to project submittal, Consultant shall perform plan review for:
 - a. Compliance with Master Plan.
 - b. Compliance with plan format in accordance with the Project's Scope of Work.
 - c. Compliance with minimum technical requirements for submittal per city's criteria and applicable standard specifications and details.
 - d. Technical accuracy.
 - e. Constructability.
 - f. Value Engineering.
 - g. Right-of-way utilization.
 - h. Compliance with COS Standards.
 4. Upon receiving review comments, consultant shall coordinate comments with applicable city departments.
 - a. Schedule a meeting to resolve any conflicts in review.
 - b. Arrange for any required departmental input on comments.
 - c. Prepare comment / response form to accompany next plan submittal.
 5. Return copy of comments to Project Manager.
 - a. Project Manager to schedule a review conference with the Consultant.
 - b. Coordinate with any COS staff to be present at review conference.
- E. Post Review Activity**
1. Attend conference with consultant and Project Manager to resolve review issues.
 2. File review documents.

Section 9-2

FACILITIES PLAN REQUIREMENTS

9-2

This section outlines the submittal and review process and requirements for public facilities, including plan sheet numbering, sequence, and content.

GENERAL INFORMATION

9-2.000

The DSPM presents clear and concise technical requirements, policies, and processes to enable design professionals to prepare plans and reports necessary for development of both public and private projects within the city.

GENERAL REQUIREMENTS

9-2.001

Refer to Appendix 9-1A for the capital project plan review process.

- A. Prepare plans on standard American National Standards Institute (ANSI) "D" Size (22 x 24 inches) sheets unless prior approval has been obtained from the city to use the larger 24 x 36 inches sheets. All sheets must be clearly reproduced on print paper in black line format.
- B. CAD files containing cover sheet, border, plan & profile and general notes are available on the [COS website](#) in MicroStation and AutoCAD format for the Consultant's. The Consultant will be responsible for completing the drawings as applicable for the project.
- C. Place a standard city title block in the lower right-hand corner of each sheet. Also, show the Consultant's identification/logo along with that of any sub-consultant, along the right edge or upper right corner of the sheet.
- D. All lettering, numbering, patterning and line work must be uniform and legible. Reproduction of final drawings must be legible when reduced to 1/2 scale. Capital Projects Management (CPM) Plan Review determines the legibility of all drawings submitted.
- E. On all sheets with maps or plans, orient north to the top or right side of the sheet. A north arrow and scale must be on all applicable sheets.
- F. Keynote all construction notes. Group construction keynotes referencing to a specific symbol (square symbols designate demolition and removals, diamond symbols designate relocations and circular shapes designate construction items).
- G. The Consultant responsible for the design must label all plans and documents submitted for review and mark them: "For Review Purposes, Not to Be Used for Bidding or Construction" and provide the percentage of completion on the documents.
- H. All projects must comply with Section 404 of the Federal Clean Water Act. Before the city may issue development permits for a project, the 404 Certification Form must be completed and submitted with improvement plans to the CPM Design and Plan Review staff. The Section 404 Certification Form is available on the COS website. Consultants are advised to apply to the USACE as early as possible for a Section 404 permit and allow for the necessary processing time to prevent delays in obtaining development permits from the city.
- I. All projects submitted for review and/or further processing must be complete and consist of plans, specifications, estimate of probable cost, structural calculations, mechanical calculations, plumbing calculations, electrical calculations, geotechnical report, drainage report, native plant information and other documentation as required for that project.

- J. For formal plan review submittal, the Consultant may submit sealed documents electronically in PDF or by paper as directed by the Project Manager. If submitting electronically refer to Section 1-3.200 for additional information. If submitting paper plans, the Consultant shall submit a minimum of 4 full size sets of plans, 2 sets of specifications and 1 set of other documents as required. In addition, the Consultant shall provide additional plans, specification and other documents as required for internal user group review purposes. All plans and documents are to be submitted to the city through CPM.
- K. Upon completion of the formal plan review process, provide an electronic copy of the signed and sealed final plans, specifications, estimate of probable cost and bid schedule in both CAD (preferably MicroStation) and PDF. The Consultant shall provide an 11x17 half size scaled PDF and a full size scaled PDF. In addition, provide the specifications, estimate of probable cost and bid schedule in Microsoft Word and Microsoft Excel formats, respectively.
- L. Any infrastructure portion of a facilities project must comply with Section 9-1.
- M. All re-submittals must include the "Attachment A" or equivalent form stating what corrective action has been taken on all review comments (refer to Appendix 9-1B).
- N. Prior to 75% completion of design, the Consultant shall submit a copy of the checklist contained herewith as Appendix 9-2A to the city Capital Projects Management (CPM) Project Manager. Check "YES" for items that have been incorporated into the contract documents or for items to be provided with close out documents. Check "NA" where items are "not applicable" or "NO" where items may be applicable but not included. Provide a written explanation of "NO" items for COS review.

PLAN SHEET NUMBERING AND SEQUENCING

9-2.100

Sheets shall be identified by design discipline as designated below and consecutively numbered. Additionally, final consecutive numbering of the entire set of plans should be provided on each sheet. The sheet numbering prefixes shown in Figure 9-2.1 are commonly used and the Consultant shall review the sheet sequencing and/or intended numbering with the city's project manager.

PLAN SHEET NUMBERING AND SEQUENCING		
Plan Sheet Prefixes		
G = General	L = Landscape	S = Structural
C = Civil	A = Architectural	M = Mechanical
		P = Plumbing
		E = Electrical
Plan Sheets Shall Be Sequenced as Follows		
1	G1	City cover sheet
2	G2	Notes, legend, approval blocks and notations
3	C1	Existing site survey
4	C2	Civil grading and drainage plans

PLAN SHEET NUMBERING AND SEQUENCING			
Plan Sheet Prefixes			
G = General	L = Landscape	S = Structural	P = Plumbing
C = Civil	A = Architectural	M = Mechanical	E = Electrical
5	C...	Civil site utility plans	
6	L1	Landscaping and irrigation plans	
7	A1	Architectural site plan	
8	A2	Architectural plans, elevations, sections, details, schedules	
9	S1	Structural general notes	
10	S2	Structural plans	
12	M1	Mechanical legends, notes, abbreviations	
13	M2	Mechanical plans, details, schedules	
14	P1	Plumbing plans, details and diagrams	
15	E1	Electrical legends, notes, abbreviations	
16	E2	Electrical site plan	
17	E3	Electrical plans, schedules and details	

FIGURE 9-2.1 PLAN SHEET NUMBERING AND SEQUENCING

DETAILED SHEET INFORMATION

9-2.200

NOTES, LEGEND, AND KEY MAP SHEETS

- A. Key Map – Show all intersections, rights-of-way and key to all plans with stations
- B. Legend of symbols used for existing and design elements
- C. List of abbreviations used in plan set (other than as shown in the MAG Specifications)
- D. Include Figure 9-1.4, General Construction Notes for Public Works Improvements and Facilities Projects in addition to any special project notes generated.

FACILITY STANDARDS

Prior to 75% completion of design, the Consultant shall submit a copy of the checklist contained herewith as Appendix 9-2A to the city Capital Projects Management (CPM) Project Manager. Check "YES" for items that have been incorporated into the contract documents or for items to be provided with close out documents. Check "NA" where items are "not applicable" or "NO" where items may be applicable but not included. Provide a written explanation of "NO" items for COS review.

A. ARCHITECTURAL

YES	NO	NA	Description of Requirements
<input type="checkbox"/>	<input type="checkbox"/>	<input type="checkbox"/>	1. Building Supplemental Instructions shall be inserted into the project specifications and listed in the table of contents.
<input type="checkbox"/>	<input type="checkbox"/>	<input type="checkbox"/>	2. COS Facilities Department shall be consulted during conceptual Heating, Ventilation and Air Conditioning (HVAC) design to review anticipated system types, equipment placement, thermostat zones of control/locations, spare parts issues, service and accessibility issues, dehumidification requirements, etc. Additional meetings shall be coordinated at the 30%, and 60% design milestones.
<input type="checkbox"/>	<input type="checkbox"/>	<input type="checkbox"/>	3. COS Facilities Department shall be consulted during conceptual roofing design to review anticipated system types, equipment placement, accessibility issues, roof access points, warranty issues, etc. An additional meeting shall be coordinated at the 60% design milestone.
<input type="checkbox"/>	<input type="checkbox"/>	<input type="checkbox"/>	4. COS Facilities Department shall be consulted at the 60% design milestone to review fall protection requirements inside/outside the building including, but not limited to, ladder locations/heights, ladder cages/platforms, equipment platforms, maintenance access issues for lighting and equipment in high ceiling areas, guard rails, roof access hatches, and roof fall protection systems/tie points.
<input type="checkbox"/>	<input type="checkbox"/>	<input type="checkbox"/>	5. Final CAD files of all drawings shall be provided with the close out documents to COS.
<input type="checkbox"/>	<input type="checkbox"/>	<input type="checkbox"/>	6. Screen walls constructed of CMU or concrete shall have integral color in the block or concrete. Split faced CMU shall not be used. Screen walls shall be coated with a COS approved anti-graffiti coating.
<input type="checkbox"/>	<input type="checkbox"/>	<input type="checkbox"/>	7. Plumbing walls shall be 2" minimum wider than the combined widths of the two largest conduits, vent lines, drainage pipes, or water lines (including insulation) anticipated to cross over each other.

FACILITY STANDARDS

			Plywood backing (if required) thickness shall also be considered when determining wall width.																																																
<input type="checkbox"/>	<input type="checkbox"/>	<input type="checkbox"/>	8. Overflow scuppers shall not be located within 36" to each side of any exterior door, and not within 24" of any electrical equipment including, but not limited to, receptacles, lights, panels and control boxes.																																																
<input type="checkbox"/>	<input type="checkbox"/>	<input type="checkbox"/>	9. Carpet squares shall be specified in lieu of rolled carpet. The Architect is encouraged to specify the following carpet and ceiling tiles as much as possible especially for non-public areas. These are COS Facilities Department standard remodel/new construction options. Product: Manufacturer, Catalog Number, Location, Used Ceiling Tiles: Armstrong, #2712 Dune, Second Look, Offices, hallways, etc. Ceiling Tiles: Armstrong, # 1721, When washable tiles are required Carpet Tiles: Shaw, Contract Group 24"x24" squares Collections: Work Life, No Rules or Feeling Plush																																																
<input type="checkbox"/>	<input type="checkbox"/>	<input type="checkbox"/>	10. The Architect is encouraged to specify the following interior paint colors as much as possible especially for non-public spaces. These are the COS Facilities Department standard remodel/new construction colors. Alternate manufacturers may be used (pending approval) but paint colors shall match those listed below. <table border="0"> <thead> <tr> <th>Color</th> <th>Manufacturer</th> <th>Catalog Number</th> </tr> </thead> <tbody> <tr> <td>Icicle</td> <td>Sherwin Williams</td> <td>SW 6238</td> </tr> <tr> <td>Gray Screen</td> <td>Sherwin Williams</td> <td>SW 7071</td> </tr> <tr> <td>Slate Gray</td> <td>Sherwin Williams</td> <td>SW 4026</td> </tr> <tr> <td>Meditative</td> <td>Sherwin Williams</td> <td>SW 6227</td> </tr> <tr> <td>Softer Tan</td> <td>Sherwin Williams</td> <td>SW 6141</td> </tr> <tr> <td>Nomadic Desert</td> <td>Sherwin Williams</td> <td>SW 6107</td> </tr> <tr> <td>Softened Green</td> <td>Sherwin Williams</td> <td>SW 6177</td> </tr> <tr> <td>Tea Leaf Green</td> <td>Sherwin Williams</td> <td>SW 6796</td> </tr> <tr> <td>Blue Plate</td> <td>Sherwin Williams</td> <td>Match COS Stadium green</td> </tr> <tr> <td>Sienna Sand</td> <td>Frazee</td> <td>8223M</td> </tr> <tr> <td>Autumn Wheat</td> <td>Frazee</td> <td>8225D</td> </tr> <tr> <td>Wild Country</td> <td>Frazee</td> <td>8735D</td> </tr> <tr> <td>Cliff Brown</td> <td>Dunn Edwards</td> <td>DEC 711</td> </tr> <tr> <td>Golden Gate</td> <td>Dunn Edwards</td> <td>DE 739</td> </tr> <tr> <td>Swiss Coffee</td> <td>Dunn Edwards</td> <td>W411 341</td> </tr> </tbody> </table>	Color	Manufacturer	Catalog Number	Icicle	Sherwin Williams	SW 6238	Gray Screen	Sherwin Williams	SW 7071	Slate Gray	Sherwin Williams	SW 4026	Meditative	Sherwin Williams	SW 6227	Softer Tan	Sherwin Williams	SW 6141	Nomadic Desert	Sherwin Williams	SW 6107	Softened Green	Sherwin Williams	SW 6177	Tea Leaf Green	Sherwin Williams	SW 6796	Blue Plate	Sherwin Williams	Match COS Stadium green	Sienna Sand	Frazee	8223M	Autumn Wheat	Frazee	8225D	Wild Country	Frazee	8735D	Cliff Brown	Dunn Edwards	DEC 711	Golden Gate	Dunn Edwards	DE 739	Swiss Coffee	Dunn Edwards	W411 341
Color	Manufacturer	Catalog Number																																																	
Icicle	Sherwin Williams	SW 6238																																																	
Gray Screen	Sherwin Williams	SW 7071																																																	
Slate Gray	Sherwin Williams	SW 4026																																																	
Meditative	Sherwin Williams	SW 6227																																																	
Softer Tan	Sherwin Williams	SW 6141																																																	
Nomadic Desert	Sherwin Williams	SW 6107																																																	
Softened Green	Sherwin Williams	SW 6177																																																	
Tea Leaf Green	Sherwin Williams	SW 6796																																																	
Blue Plate	Sherwin Williams	Match COS Stadium green																																																	
Sienna Sand	Frazee	8223M																																																	
Autumn Wheat	Frazee	8225D																																																	
Wild Country	Frazee	8735D																																																	
Cliff Brown	Dunn Edwards	DEC 711																																																	
Golden Gate	Dunn Edwards	DE 739																																																	
Swiss Coffee	Dunn Edwards	W411 341																																																	
B. STRUCTURAL																																																			

FACILITY STANDARDS

YES	NO	NA	Description of Requirements
<input type="checkbox"/>	<input type="checkbox"/>	<input type="checkbox"/>	1. A standard detail for a foundation footer pipe chase shall be included in the structural drawings to route electrical, plumbing, SD services, etc. intended to extend to/from interior/exterior walls when required to run deeper than the wall footing.
C. PLUMBING			
YES	NO	NA	Description of Requirements
<input type="checkbox"/>	<input type="checkbox"/>	<input type="checkbox"/>	1. When a condensate line from HVAC equipment empties into a floor or mop sink, the drainage line serving the sink shall be a minimum of one size larger than the condensate line. Condensate lines shall not empty into a floor drain.
<input type="checkbox"/>	<input type="checkbox"/>	<input type="checkbox"/>	2. Storm water pumps shall be wired to a waterproof controller, have a COS compatible signal system and shall have both local and Metasys alarm capability.
<input type="checkbox"/>	<input type="checkbox"/>	<input type="checkbox"/>	3. Sewage ejectors shall have a submersible vortex motor with recessed
<input type="checkbox"/>	<input type="checkbox"/>	<input type="checkbox"/>	4. Roof drain piping shall be a minimum of 3".
D. HVAC			
YES	NO	NA	Description of Requirements
<input type="checkbox"/>	<input type="checkbox"/>	<input type="checkbox"/>	1. Design shall conform to the following: <ol style="list-style-type: none"> a. Summer Exterior Conditions- 120-degree F dry bulb, 76-degree F wet bulb b. Winter Exterior Conditions – 34-degree F dry bulb c. Interior – 72-degree F dry bulb cooling, 74-degree F dry bulb heating d. The system shall provide dehumidification as required per COS direction
<input type="checkbox"/>	<input type="checkbox"/>	<input type="checkbox"/>	2. Multi-zone packaged AC units shall not be used.
<input type="checkbox"/>	<input type="checkbox"/>	<input type="checkbox"/>	3. Variable air volume (VAV) systems with variable speed fans shall be used in lieu of constant volume systems.
<input type="checkbox"/>	<input type="checkbox"/>	<input type="checkbox"/>	4. HVAC units shall not serve more than one floor in multi-floor buildings.
<input type="checkbox"/>	<input type="checkbox"/>	<input type="checkbox"/>	5. All zones shall have independent heating and cooling capabilities.
<input type="checkbox"/>	<input type="checkbox"/>	<input type="checkbox"/>	6. Systems that are equal to or greater than 25 tons shall be a four pipe or a central air handling system with variable frequency drive (VFD) and HW coil in fan powered VAVs.
<input type="checkbox"/>	<input type="checkbox"/>	<input type="checkbox"/>	7. Electric heat strips shall not be specified.
<input type="checkbox"/>	<input type="checkbox"/>	<input type="checkbox"/>	8. Cooling towers shall conform to the following: stainless steel construction, non-sprinkled dual cell, plastic fill and metering devices, vertical discharge propeller fan,

FACILITY STANDARDS

			fan motor not the in-air stream, a bypass system for low temperature operation, and VFD motor control.
<input type="checkbox"/>	<input type="checkbox"/>	<input type="checkbox"/>	9. 25-100-ton units shall have reciprocating or scroll compressors.
<input type="checkbox"/>	<input type="checkbox"/>	<input type="checkbox"/>	10. 100+ ton units shall have screw or centrifugal open drive and VFD controlled compressors.
<input type="checkbox"/>	<input type="checkbox"/>	<input type="checkbox"/>	11. The HVAC system one line and/or control diagram shall include reference to the requirements of the HVAC Building Automation System as described in the COS Supplemental Instructions specification section.

E. ELECTRICAL

YES	NO	NA	Description of Requirements
<input type="checkbox"/>	<input type="checkbox"/>	<input type="checkbox"/>	1. All restrooms, utility rooms (electrical, mechanical, etc.), kitchens and accessible plumbing chases shall be provided with wall mounted emergency lighting or (if provided) shall be connected to the emergency generator.
<input type="checkbox"/>	<input type="checkbox"/>	<input type="checkbox"/>	2. 120/277V branch circuits serving inductive lighting loads and electronic equipment shall have a neutral wire sized one size larger than the ungrounded conductor it serves.
<input type="checkbox"/>	<input type="checkbox"/>	<input type="checkbox"/>	3. All transformers serving branch panels with inductive lighting loads and/or circuits that serve receptacles for electronic equipment shall be K rated.
<input type="checkbox"/>	<input type="checkbox"/>	<input type="checkbox"/>	4. All fluorescent lighting shall be rated at 4100K.
<input type="checkbox"/>	<input type="checkbox"/>	<input type="checkbox"/>	5. Bollards and in-ground up lights shall not be used for exterior lighting.
<input type="checkbox"/>	<input type="checkbox"/>	<input type="checkbox"/>	6. The Service Entrance Station (SES) main OCPD and all OCPDs serving branch/distribution panels 400A and greater shall be fused.
<input type="checkbox"/>	<input type="checkbox"/>	<input type="checkbox"/>	7. All exterior lighting located 8'-00" above finish floor (AFF) and below shall be vandal resistant.
<input type="checkbox"/>	<input type="checkbox"/>	<input type="checkbox"/>	8. All HVAC disconnect switches shall be fused.
<input type="checkbox"/>	<input type="checkbox"/>	<input type="checkbox"/>	9. Disconnect switches with pull out style fuse blocks shall not be specified.
<input type="checkbox"/>	<input type="checkbox"/>	<input type="checkbox"/>	10. Coordinate with COS security system vendor requirements for conduits, sleeve placement through inaccessible spaces, requirements for access control points, cable routing through fire rated walls, device locations, door/door frame access requirements, etc... Identify these requirements on the construction documents.
<input type="checkbox"/>	<input type="checkbox"/>	<input type="checkbox"/>	11. Restroom exhaust fans shall be switched with the lighting.

FACILITY STANDARDS

<input type="checkbox"/>	<input type="checkbox"/>	<input type="checkbox"/>	12. All water heaters powered by a photovoltaic system shall be designed with a manual transfer switch and a backup normal power service.
<input type="checkbox"/>	<input type="checkbox"/>	<input type="checkbox"/>	13. Provide Arc Flash Warning Label flash and shock protection information for all electrical panels. Information shall include, but shall not be limited to: incident energy, required Personal Protection Equipment (PPE) level, required PPE equipment, and boundary limits for limited approach, flash protection, restricted and prohibited approaches. Provide information to the electrical contractor for panel labeling requirements.
F. PHOTOVOLTAIC SYSTEMS			
<input type="checkbox"/>	<input type="checkbox"/>	<input type="checkbox"/>	1. Drawings shall include the following: <ul style="list-style-type: none"> a. All grounding and bonding system equipment connections, ratings, and sizes b. A one-line diagram showing all AC and DC equipment, conduit and wire sizing and utility service connections. c. Fault current calculations. d. Voltage drop calculations for AC and DC circuits. Voltage drop shall not exceed 3%. e. Calculations verifying there shall not be more than a 15% depth of discharge on battery systems
<input type="checkbox"/>	<input type="checkbox"/>	<input type="checkbox"/>	2. All heat sensitive PV equipment downstream of the solar modules shall be shielded from direct sunlight. Inverters shall be in a temperature-controlled space and shall not be placed adjacent to heat generating equipment.
<input type="checkbox"/>	<input type="checkbox"/>	<input type="checkbox"/>	3. Per 2012 NEC Table 690.31(C), all field installed exterior conductors and conductors located in non-air-conditioned spaces (regardless of equipment terminal ratings) shall be calculated and sized as 60°C rated conductors operating in an ambient temperature of 114-122°F.
<input type="checkbox"/>	<input type="checkbox"/>	<input type="checkbox"/>	4. Per 2012 NEC 690.32(E) option #1: all connectors shall be rated for interrupting current without hazard to the operator.

Section 9-3

CONSTRUCTION BID DOCUMENTS

9-3

This section provides specific requirements for construction bid documents for city public works projects. It gives direction for preparing construction drawings, discovering a project's special provisions, creating a bid schedule, and estimate of probable costs.

GENERAL INFORMATION

9-3.000

The project's scope of work will contain specific requirements for the construction documents provided by the consultant. Generally, the consultant provides the following bidding documents to the city. The Project Manager determines how many copies of each document are needed.

- A. Construction Plans
- B. Project Special Provisions
- C. Project Schedule of Bid Items
- D. Estimate of Probable Cost

CONSTRUCTION DRAWINGS

9-3.100

Original drawings submitted to the city will remain the property of the city. Prepare plans on standard ANSI "D" Size (22 x 24 inches) sheets unless prior approval has been obtained from the city to use the larger 24 x 36 inches sheets. All sheets must be clearly reproduced on print paper in black line format.

The Consultant shall provide an electronic copy of the signed and sealed final plans, specifications, estimate of probable cost and bid schedule in both CAD and PDF. The Consultant shall provide an 11x17 half size scaled PDF and a full size scaled PDF. In addition, provide the specifications, estimate of probable cost and bid schedule in Microsoft Word and Microsoft Excel formats respectively.

- A. Architects shall provide to the Project Manager for the Facilities Department's use a floor plan with door tags showing door and room numbers in CAD and PDF for the city's locksmith's use. CAD and PDF files shall be submitted to the Project Manager at the end of the conclusion of the design phase and prior to start of construction.
- B. Architects shall provide Evacuation Routes in PDF to the Project Manager for Facilities Department's use for all new and remodeled facilities.

SPECIAL PROVISIONS / TECHNICAL SPECIFICATIONS

9-3.200

"Invitation to Bid" documents follow a specific format for all Capital Improvement Projects. They include city drafted boiler plates consisting of the notice inviting bids, information for bidders, general conditions, bid forms, contracts, bonding and insurance forms, etc. The project's special provisions / technical specifications will supplement the city's general conditions.

The special provisions / technical specifications are written for the purpose of describing a unique work function or activity for a particular construction project. The special provisions / technical specifications will include description, materials, construction requirements, measurement and payment for project items. The special provisions / technical specifications define which work items are measured and how they are paid within each bid item. They also define which work items are not measured separately and are considered as included in the project overhead.

BID SCHEDULE

9-3.300

The consultant will complete a [standard schedule of bid items](#) consistent with the city's required format.

Bid item numbers will be taken from a master list of items that is available on the COS website. Project specific item numbers that are not listed will be requested from the Project Manager.

The master bid item list is frequently updated, so the consultant should visit the COS website frequently for the current version.

ESTIMATE OF PROBABLE COSTS

9-3.400

The engineer / architect will provide the city with a detailed estimate of the probable cost of construction at interim and final project submittals.

Chapter 10

NATIVE PLANTS

10

This chapter identifies protected native plants within the city, describes the process for requesting a Native Plant Permit when relocating, removing, or destroying these plants, and presents guidance for salvaging and transplanting saguaros.

PROTECTED NATIVE PLANTS

10-1.000

Specific native plants are protected as described in the city’s Native Plant Ordinance. Photos of indigenous plants, including the protected native plants listed below, are available at: www.scottsdaleaz.gov/codes/native-plant .

TREES

BOTANICAL NAME	COMMON NAME
<i>Acacia constricta</i>	Whitethorn Acacia
<i>Acacia greggii</i>	Catclaw Acacia
<i>Berberis haematocarpa</i>	Red Barberry
<i>Canotia holocantha</i>	Crucifixion Thorn
<i>Celtis pallida</i>	Desert Hackberry
<i>Cercidium floridum</i> (<i>Parkinsonia florida</i>)	Blue Palo Verde
<i>Cercidium microphyllum</i> (<i>Parkinsonia microphyllum</i>)	Foothills Palo Verde
<i>Chilopsis linearis</i>	Desert Willow
<i>Juniperus monosperma</i>	1-Seeded Juniper
<i>Olneya tesota</i>	Ironwood
<i>Populus fremontii</i>	Cottonwood
<i>Prosopis species (spp.)</i>	Mesquite
<i>Quercus spp.</i>	Scrub Oak
<i>Rhus ovata</i>	Sugar Sumac
<i>Vauquelinea californica</i>	Arizona Rosewood

CACTI

BOTANICAL NAME	COMMON NAME
<i>Carnegia gigantea</i>	Saguaro
<i>Ferocactus spp.</i>	Barrel
<i>Fouquieria splendens</i>	Ocotillo
<i>Peniocereus greggii</i>	Desert Night-Blooming Cereus
<i>Yucca elata</i>	Soaptree Yucca

NATIVE PLANT PERMITS

10-1.100

No protected plant material as defined in Section 10-1.000 may be relocated, removed, or destroyed without a native plant permit. No native plant permit shall be issued unless an application is submitted in conjunction with an existing or proposed development for approval. The submittal is separate from any other native plant submittal required for a Zoning Application, a Development Review Board (DRB) Application, or a Preliminary Plat Application. For a native plant permit to be issued, the following items (identified as A through I below) must be submitted to the City of

Scottsdale (city) One Stop Shop. If the applicant takes no action to complete a submittal, it will be purged from the system after six months and fees will not be refunded.

SUBMITTAL REQUIREMENTS

10-1.101

A. Native Plant Application Form

A completed Native Plant Permit: Application and Narrative Form is required. Refer to www.scottsdaleaz.gov/codes/native-plant for this form.

B. Native Plant Program

A Native Plant Program with the following information is required.

1. Submit three copies of a native plant plan on an aerial photograph with a project (or site plan) overlay. On the plan, show the location of all protected native plants (by tag number) within the construction boundaries, and an additional 50-foot buffer beyond the construction limits, or to the edge of the property.
The aerial site plan shall include the project name, scale that is numeric and graphic (minimum scale is 1 inch = 50 feet), north arrow, vicinity map, adjacent street names, and name of the company performing the inventory.
2. Submit an inventory list, minimum 8.5-inch x 11-inch sheet, identifying the tag number, species (list both common and botanical names), size, general condition, and salvage status (remain in place, relocate, or remove) of each protected plant within the area of disturbance plus a 50-foot buffer. If a plant is noted as non-salvageable, the reason or reasons for the assessment must also be noted. A protected native plant includes trees with a 4-inch caliper trunk or larger, and cacti that are 3 feet tall or taller.
 - a. Measurements are to occur prior to any pruning or branch removal operations and must consider the entire base of the tree.
 - b. To measure the trunk of a tree, it must first be determined whether the tree is single-trunk or multi-trunk.
 - c. A single-trunk tree is a tree with a single-trunk protruding above grade, attached to a single root ball. The diameter of single-trunk trees is measured at a point 12 inches above grade. If the tree starts to branch before that point, the measurement is taken at the point where the branching begins.
 - d. A multi-trunk tree is a tree with more than one trunk (2 of which are 3 inches or greater in diameter) protruding above grade from a single root ball and being separated by any portion of each. Multi-trunk trees are measured by the following method:
 - iii. Square the diameter of each trunk
 - iv. Add the squared diameters of all the trunks together
 - v. The square root of the total above is the working diameter for that tree.
 - e. A cactus is measured from the base at grade to the highest vertical point of the plant. The height of all arms is also included in the total. Ocotillo and Yucca are also measured in this way, except that the flower stalk of the Yucca is not included.
3. A salvage contractor must have prior methodology approval by city staff. A native plant inventory will not be accepted from a contractor whose

methodology has not received prior approval. Approval includes demonstrating a thorough knowledge of the native plant ordinance and native plant boxing techniques. If the cacti salvage contractor is different than the tree salvage contractor, both methodologies will need to be reviewed and approved. If the salvage contractor is different than the party responsible for the inventory, the salvage contractor must provide a letter either accepting the assessment by the party responsible for the inventory or provide documentation for any proposed adjustments to the inventory. Please contact the Current Planning Department at 480-312-7000 for information on obtaining approval to be placed on the list of native plant salvage contractors.

Due to the large number of Saguaros that have died after being transplanted, and the length of time for the decline of the plant to be identified, the city, in conjunction with the Desert Botanical Garden, has established baseline standards for Saguaro relocation, see Section 10-1.200. Any deviation from an approved methodology or the Standards for Saguaro relocation requires prior city review and approval.

4. Submit a relocation program identifying the ultimate use and placement of salvaged plant material, including any proposals for plants to be removed from the project.
5. Submit a nursery location for the storage of salvaged plants.

C. Letter of Authorization

Submit a letter of authorization from the property owner or authorized agent identifying a salvage contractor whose methodology has been previously approved by the city. For single-family home submittals, the name of the salvage contractor will be noted on the native plant portion of the planning submittal. Because the salvage contractor is listed on the native plant permit issued through the One Stop Shop; a different salvage contractor may not be employed once the native plant permit has been issued. If the owner wishes to employ a different salvage contractor, the name of the new contractor must appear on the native plant permit before salvage work commences.

D. Notice of Intent to Clear Land

Submit a copy of the stamped [Arizona Department of Agriculture](#) "Notice of Intent to Clear Land" form. To obtain the form, contact the Native Plant Section of the Arizona Department of Agriculture at 602-542-3578.

E. Notice of Tagging of Plants in the Field

Submit notice that all protected plants have been tagged in the field in conformance with Section 46-116 of the Scottsdale Revised Code (SRC).

1. White tag for plants remaining in place
2. Red tag for plants being relocated/salvaged.
3. Blue tag for plants which are non-salvageable.

The independently hired native plant salvage contractor will be responsible for tagging each plant accordingly. Plants with white tags or no tags shall be protected in place for the duration of the project regardless of salvage status. Tags shall be numbered to correspond to the inventory. In addition, construction boundaries, Natural Area Open Space (NAOS), and other undisturbed areas need to

be clearly staked in the field with plastic fencing, yellow nylon rope, or other means approved by a City Inspector. The City Inspector can be contacted by calling Inspection Services at 480-312-5750.

F. NAOS

This is an exhibit of showing the site. Submit a copy of the NAOS exhibit for the site, showing locations of both natural and revegetated areas to be dedicated. All NAOS easements must be staked and roped in the field at the time of the native plant field walk. The native plant field walk is done before any site disturbance and is conducted with the City Inspector.

G. Review Fee

An initial fee is charged for the first hour in plan review. Additional review time will be charged per hour at the time the permit is issued. For single-family homes, this fee is included as part of the planning site plan [review fee](#).

H. Prior Approvals

If a project requires approval from the DRB, the City Council, and/or the Board of Adjustment, the native plant permit will not be issued until the above-mentioned approvals have been finalized. This prior-approval requirement includes single-family homes. The native plant permit for all single-family custom homes will be issued concurrent with the building permit. Please note that no native plant permit can be issued unless there is an approved development plan for the site.

I. Permit Fee

At the time a permit is issued, a fee will be due to the city. Fees vary by project and consist of a base fee plus a per-plant charge for each native plant to be relocated or destroyed. An administrative fee will also be added to the cost of each permit.

INSPECTIONS

10-1.102

City staff will conduct the following inspections during the permit review process and the construction of the project.

A. Field Walk

The field walk is part of the first review of the Native Plant Program for commercial developments, plats, and miscellaneous projects. For single-family homes, the field walk is part of the Preliminary Site Inspection. The purpose of the field walk is to verify the accuracy of the native plant inventory and to identify other items that may allow for the greatest preservation of protected plant material.

B. Preliminary Site Inspection

Preliminary Site Inspection (#42 Pre-Site Inspection) occurs once a Native Plant Permit is issued, but prior to any salvage activities. At the time of this inspection, the applicant must present the copy of the approved Native Plant Program stamped "Inspectors Copy," and a copy of the permit. A permit inspection card, also issued with the permit, is required to be posted on the site at all times.

C. Nursery Inspection

The nursery/maintenance inspection is done to assess the results of the native plant relocation process. It takes place approximately 3 months after the last of the salvageable plants have been placed in the nursery and before the issuance of the

Certificate of Occupancy (C of O) for the project. The plant identification number from the inventory list needs to be clearly marked on the box or plant.

D. Native Plant Tracking Form

The [Native Plant Tracking Form](#) tracks the overall success rates of salvaged protected plants. These numbers are quantified as part of the city's Sustainability Indicators Project. The tracking form is submitted to the City Inspector. Any project that requires a native plant permit needs to submit a tracking form. The tracking form must be submitted within three months from the commencement of salvage operations or prior to the issuance of the C of O for R1- projects.

E. Final Inspection

The final inspection is to verify the ultimate planting location of salvaged plant material.

ACTIONS ON APPLICATIONS

After a Native Plant Permit application has been submitted, city staff may take one of three courses of action:

- A. The application may be approved, and the permit issued;
- B. The application may be approved with conditions, and the permit issued; or
- C. The application may be denied, with conditions for approval.

Action taken on an application may be appealed to the DRB in conformance with the procedures in Article I of the Scottsdale Zoning Ordinance. Submittals that are not acted upon within 6 months will be purged from the system and any fees paid are not refundable.

SAGUARO SALVAGE AND TRANSPLANTATION

- A. Dig around saguaro leaving a minimum of 2 feet of root out from the base and deep enough to allow for removal of a reasonable portion of the root ball.
- B. Prune any shredded or damaged roots and dust with sulfur and streptomycin.
- C. Planting hole should have 1 foot of loose native soil and be large enough to accommodate the larger lateral roots.
- D. Saguaro should be re-planted at the same depth or no more than 6 inches deeper than its original position.
- E. Mark original north orientation so saguaro may be re-planted in the same direction to reduce risk of sunburn.
- F. Pack thoroughly, using a mixture of native soil and sandy soil to promote root growth and better drainage.
- G. After transplant, allow 2-3 weeks for damaged roots to heal before first water.
- H. Water, by drip irrigation, every 2 weeks during the first year and once a month during the second year after transplant. If planted alone or within a nursery, place four 1- gallon per hour emitters, evenly spaced 2 to 3 feet from base, and allow water to run for 8-15 hours per session.
- I. If planted as a final location within landscaped areas, planting saguaro at least 4 feet from small shrubs or a tree is ideal.
- J. If a moat system is approved by the city, a circular swale should be dug that is approximately 1 foot wide by 4 inches to 6 inches deep at center, and at distance 3

10-1.103

10-1.200

to 4 feet out from the saguaro trunk. Water slowly and thoroughly twice a month for no less than 2 years.

- K. Developer will ensure that maintenance of the saguaro shall be provided for a minimum of 2 years from the time of placement at its final location.
- L. Saguaro is established once it responds to rainfall by expanding.
- M. Variations from the above process will require approval from a City Inspector.

NON-PROTECTED PLANTS AND TREES

10-1.300

Plants and trees which are not protected by the Scottsdale Revised Code (SRC) native plant provisions, but which are necessary for on-site revegetation, are suitable for transplanting, and are necessarily uprooted for road building or similar construction, as determined by city staff, shall be stockpiled during construction and shall be replanted in on-site landscape areas by the developer before the final site inspection.

Chapter 11

FIRE

11

This chapter describes how the building code, fire code, infrastructure system, and site design policies are integrated into an effective fire protection design. It lists links to applicable code and trade organizations and to other chapters describing related design topics.

GENERAL INFORMATION

11-1.000

This section provides Fire and Life Safety information, guidelines and references specific to site planning and development. For updated information refer to the [Fire and Life Safety](#) website or to contact Fire Plan Review, call 480-312-2500.

The following websites provide safety codes, standards and general information:

[American Fire Sprinkler Association](#)

[Arizona Automatic Fire Alarm Association](#)

[Home Fire Sprinkler Coalition](#)

[International Code Council](#)

[National Fire Protection Association](#)

[National Fire Sprinkler Association](#)

[Occupational Safety and Health Administration](#)

[Society of Fire Protection Engineers](#)

OVERVIEW OF FIRE PROTECTION

11-1.100

A. Adequate Fire Protection Design

Must coordinate compliance with building and fire codes, site design policies and public infrastructure needs. The principal considerations for fire protection are addressed online in [Codes, Ordinances and Regulatory Documents](#). Examples of principal considerations for building design are:

1. Fuel load
2. Building structure size
3. Structure construction methods
4. Built-in fire protection such as: fire sprinklers, fire alarms, hose valves, etc.
5. Number of occupants
6. Hazard level of the use of the structure

B. Site Planning Considerations Include:

1. Building access by fire trucks
2. Site access from adjacent streets
3. Water supply in terms of system pressure and volume capacity

C. Examples of How These Considerations Work Together

The required number of access points depends on the volume of the fuel load (number of structures, square footage of structures and/or hazard level).

Topography (Hillside, Environmentally Sensitive Land area, washes, etc.).

Available water volume influences on fire protection planning (gallons per minute (gpm), pressure and hydrant systems, built in fire protection and operations).

Remediation of site challenges to provide appropriate access, adequate water supply, or overcoming difficult topography may be accomplished by increasing the protection level of construction methods and materials.

Remediation may also be accomplished using built-in fire protection such as increasing the protection level of fire sprinklers, hose valves, fire alarms, etc.

Many remediation methods are available in the City Code, may require staff approval, or may require a variance. Consideration of remediation methods and

consequences should start during or immediately following Pre-Application and should be concluded as much as possible prior to case approval. This will facilitate a successful and timely review and approval of building plans, improvement plans and deferred shop drawings.

CASE APPLICATION

11-1.200

Review of applications for site development is a coordinated effort by Fire Plan Review and Planning and Development staff. Applications include: Pre-application, Zoning, Development Review, Preliminary Plat, Abandonment and Conditional Use Permits (CUPs).

For development process, refer to Section 1-1.100.

For preliminary site review minimum requirements, refer to Section 1-1.200.

Site planning issues to be addressed are typically communicated to the applicant by Planning and Development Services staff or by Fire Plan Review staff. Appropriate fire apparatus access, turning radius, and fire hydrant placement are necessary considerations for site planning. A preliminary site plan review must include:

A. Turning radius templates

B. Building construction type

C. Square footage of each floor level

D. Identification of hazardous conditions and use/occupancy classifications

A Preliminary Fire Review Worksheet may be required. This will be provided to the applicant at Pre-application and will be completed as much as possible and returned with the formal application. This Worksheet is simple and should be considered a living document to progress in completion and complexity as the project moves through the planning process. Ultimately the information will be completed and provided in the Project Data/Code Summary in the building plan construction document plan set.

The applicant will receive a first review comments letter from the planning coordinator with a list of Fire Ordinance Requirements which become stipulations to the application. The requirements are based on the plans submitted with the application and are intended as a guide for the applicant's design team. These requirements are to be noted on the construction documents under a general Fire Department note block. A marked-up site plan will accompany the requirements provided to the applicant who will identify the fire lanes, fire hydrants, Fire Department connection locations, etc. The applicant's design team shall utilize this information to prepare improvement plans.

PLAN REVIEW AND PERMITTING

11-1.300

The Fire Plan Review staff participates in plan review and permitting for the built environment. For information about plan review and permitting refer to Section 1-1.400 and Section 1-2.100.

A. Location

The Plan Review department is located at One Civic Center, 7447 E. Indian School Road, Suite 125, Scottsdale, AZ 85251

B. Permit Services

For Permit Services visit the [One Stop Shop](#) in Suite 100 of the same building.

C. Other Information

For more information see [Fire and Life Safety](#) or to contact Fire Plan Review call 480-312-2500

D. Plan Review and Permits

1. For specific information about Plan Review and Permit requirements:
2. Plan Review and Permitting Section 1-1.400.
3. Construction Plan Submittals Section 1-2.100.
4. Improvement Plan Review Requirements Section 1-2.100.
5. Digital Plan Submittals Section 1-2.200.
6. Fire Protection Design Section 6-1.500 through Section 6-1.508.
7. Final Improvement Plans Preparation Section 6-1.600.
8. [Fire Code](#):
9. [Forms, Checklists and Submittal Guides](#)
10. [Permit Services](#) - One Stop Shop

E. Special Events Fire Plan Review and Permitting

Fire and Life Safety also conducts Plan Review and Permitting for Special Events.

F. More Information

For more information refer to [Fire and Life Safety](#) or call 480-312-1855.

FIRE INSPECTION AND CERTIFICATE OF OCCUPANCY (C OF O)

11-1.301

A. Guidelines

For guidelines on these topics refer to Section 1-1.500 and Section 1-1.600.

B. Permit Services

For Permit Services visit the [One Stop Shop](#) in Suite 100 of the same building.

C. More Information

For more information refer to [Fire and Life Safety](#) or call Fire Plan Review at 480-312-2500.

EMERGENCY ACCESS & FIRE LANES

11-1.400

Technical information applicable to emergency access in commercial and residential development is referenced below. Considerations for commercial and residential site planning may include: appropriate access to structures including temporary construction access, fire lane position and widths, or fire apparatus turning radius. Emergency access is required in accordance with the [Fire Code](#), as amended. Fire Ordinance Requirements and a Fire Civil Submittal Checklist are located under [Forms, Checklists and Submittal Guides](#)

A. General

1. [Knox Applications](#)
2. Access During Construction Section 1-1.405
3. Temporary Construction Fire Lane Section 1-1.405
4. Construction Access Sign Section 1-1.405 and Figure 11-1.1
5. Vertical Curbs, Emergency Vehicles Section 5-3.113
6. Median Crossing for Emergency Vehicles Section 5-3.113.

7. Traffic Signal Emergency Vehicle Pre-emption Section 5-4.106.

B. Commercial Site Planning

1. International Fire Code (IFC) Ordinance, City of Scottsdale (COS) Detail No.2365
2. Fire Lane Dimensions Figure 2-1.1.
3. Commercial On-Site Fire Access Turn-Arounds Figure 2-1.2.
4. Emergency Access Provisions Section 2-1.800.
5. Fire Lanes and Fire Lane Signage Section 2-1 and Chapter 11.

C. Residential Site Planning

1. General Residential On-Site Fire Access Turn-Arounds Figure 2-1.2.
2. Residential Gated Entrances Section 2-1.706 and Figure 2-1.3.
3. Residential Driveways Section 2-2.308.
4. Hillside Residential Development Section 2-2.308.
5. Hillside Residential Driveways Figure 2-2.7.
6. Operations Platform Section 2-2.308 and Figure 2-2.5.
7. Fire Turn-out for Extended Driveways Section 2-2.308 and Figure 2-2.6.
8. Dead End Streets, Cul-de-sacs Section 5-3.1100.
9. Neighborhood Traffic Management Section 5-9.

WATER SUPPLY

11-1.500

References below are specific to water supply requirements for fire operations and fire hydrant layouts in residential and commercial developments.

A. Fire Hydrant Flow Test Permit

Search for [forms](#)

B. Permit Services

Visit the One Stop Shop in Suite 100 of One Civic Center; or [Permit Services](#)

C. Dead-End Lines

Section 6-1.403

D. Thrust Restraint

Section 6-1.411

E. Pipe Cover

Section 6-1.413

F. Backflow Prevention and Cross Connection Controls

Section 6-1.417.

G. Fire Hydrant Locations, Including Layout, Placement and Number:

Section 6-1.502.

H. Fire Lines

Section 6-1.504.

1. 1-1/2 – 2 inches fire line connection; COS Detail No. 2362-1*
2. 3 inches and larger fire line connection; COS Detail No. 2362-2

FIRE PROTECTION

11-1.600

References below are specific to Fire Protection and Water Supply.

A. Fire Protection

General, Ordinance Requirements, Design Policy

Section 6-1.500.

B. Fire Flow Requirements

Section 6-1.501.

C. Hydrant Locations

Section 6-1.502.

D. Pavement Markers

Section 6-1.503.

E. Building Sprinklers System

Section 6-1.505.

F. Sprinkler System Design

Section 6-1.506

1. Fire Sprinkler Riser Detail - Vertical Installation #1; COS Detail No. 2368*

2. Fire Sprinkler Riser Detail - Vertical Installation #2; COS Detail No. 2369*

G. Fire Department Connections

Section 6-1.507.

Remote Siamese Connection Detail, COS Detail No. 2367*

H. Auxiliary Storage Tanks

Section 6-1.508

I. Fire Department Permit Applications

Such as tents and other (bonfires, LPG exchange, special events, fireworks display, etc.)

www.scottsdaleaz.gov/fire/prevention-inspection/fire-permits

J. Fire Alarms

<http://www.scottsdaleaz.gov/licenses/alarms>

K. Fire Hydrant Flow Test Summary

www.scottsdaleaz.gov/planning-development/forms

SIGNAGE

11-1.700

References below are specific to the signage requirements for the Fire Department.

See [COS Standard Detail](#) 2300 Series – Water Information:

A. Pavement Markers for Fire Hydrants

COS Detail No. 2363*

B. Fire and Emergency Access and Delineation

COS Detail No. 2364*

C. Fire Lane Sign

COS Detail No. 2365*

D. Construction Access Sign

Section 1-1.405 and Figure 11-1.1

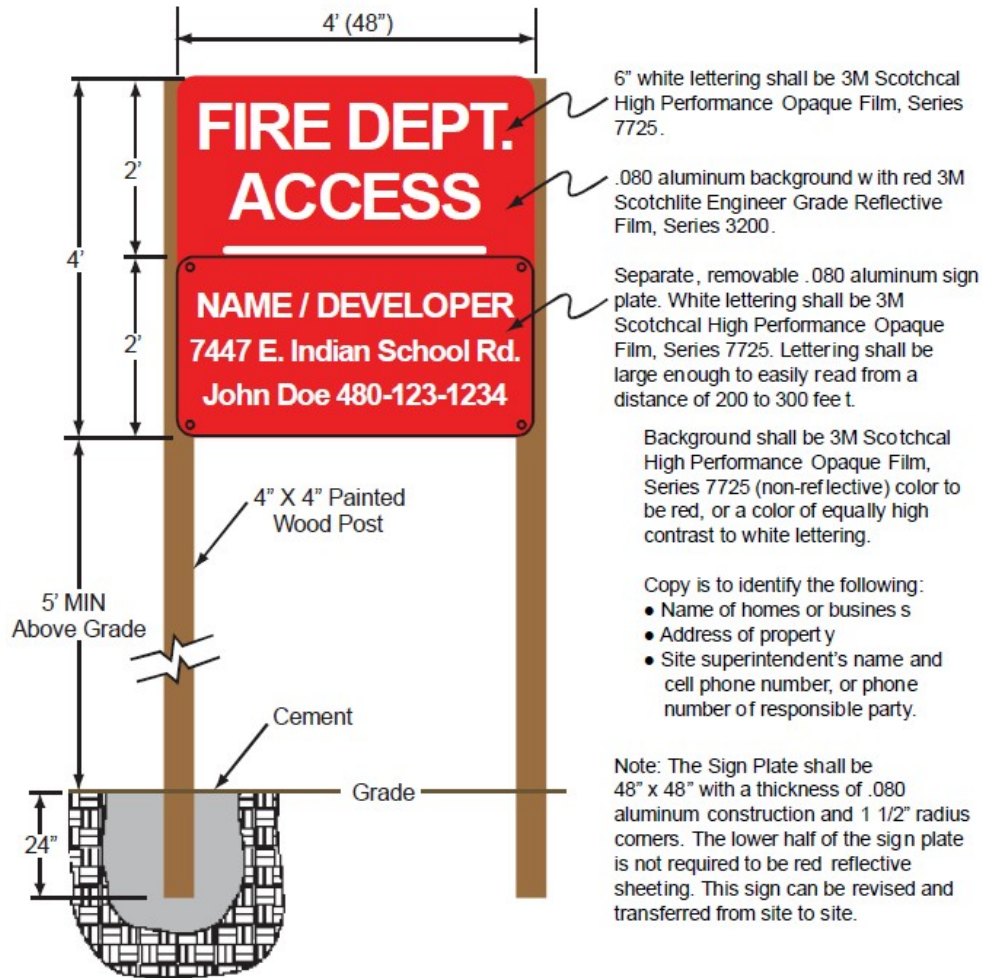

FIGURE 11-1.1 CONSTRUCTION ACCESS SIGN

WILDLAND BOUNDARY

11-1.800

For information about Firebreaks refer to Section 2-2.501 paragraph D.2. For Wildland Fire Prevention refer to www.ScottsdaleAZ.gov/fire/wild-fire-prevention

HIGH RISE CONSIDERATIONS

11-1.900

For Fire Flow Requirements information refer to Section 6-1.501. For project specific information call Fire Plan Review at 480-312-2500.

Radio amplification testing for emergency services is required in basements, buildings exceeding 35 feet above grade, and other buildings where construction materials may hinder emergency radio signaling. Testing shall be conducted to verify if adequate radio signal strength is, or is not, available. Adequate signal strength shall be determined at or before the time of completion of rough framing or rough electrical. City emergency services shall be contacted prior to that stage to assist the developer's contractor or specialist in testing the structures for signal strength. If it is determined that the signal strength as listed in Scottsdale amendment to NEC 810 is not adequate,

the owner shall provide a system of a radio amplification to meet these radio frequency strength requirements. No C of O will be issued until final approval of the testing and/or inspection of the system. Refer to City of Scottsdale, Planning and Development Services Department, Interpretations and Applications of the Building Codes and Regulations #98-5.

DOWNTOWN

11-1.1000

Renovation and/or reclassification of existing R-3 and IRC single family residential occupancies to Group B office business occupancies may be equipped with a light hazard commercial sprinkler system utilizing a four-head flow calculation. The intent is to result in smaller fire line taps, supply lines, and riser sizing. See Fire Code, Interpretation and Applications.

Residential fire sprinkler retrofits in existing single-family R-3 or IRC residences may be evaluated, at owner's request, for the opportunity to maintain existing supplies and meter sizes.

For project specific information call Fire Plan Review at 480-312-2500 or refer to www.scottsdaleaz.gov/fire/prevention-inspection/fire-permits.

DISABILITY ACCESS

This chapter includes references to laws, ordinances, policies, and guidelines for accessibility within Scottsdale, as they relate to both on-site and off-site development. Advisory and best practice portions are prefaced by the word "Note:" and are intended as additional guidance on the understanding and application of requirements.

GENERAL INFORMATION

12-1.000

The City of Scottsdale (city) is committed to improving accessibility and equal access for all of its citizens. The Americans with Disability Act (ADA) requires that local governments as well as those involved in design and construction apply the minimum accessibility standards and regulations to remove barriers and construct improvements that meet accessibility requirements.

ACCESSIBILITY CODES

12-1.100

A. Adopted Building Codes

The primary adopted accessibility codes for design and construction within Scottsdale are:

1. The 2015 International Building Code (IBC)
2. The 2015 International Existing Building Code (IEBC)
3. The 2009 ICC American National Standards Institute (ANSI) A117.1 Standards (ANSI A117.1)
4. The 2010 Americans with Disabilities Act Standards for Accessible Design (ADAAG)

Note 1: Please check our website page "[Codes & Ordinances](#)" for code amendments and updates to code adoption.

Note 2: The Fair Housing Act, the ADA and ADAAG are state and federal civil rights laws.

Compliance with city enforcement of accessibility codes does not insure compliance with state and federal accessibility laws.

B. Multifamily Requirements

Chapter 11 of the IBC and Chapter 10 of ANSI A117.1 are the primary code sources for multifamily building accessibility.

Note 1: When a choice is made to use either the ANSI A117.1 or ADA Stds for sites and interior/exterior common areas, that choice must be specified on the building code data for the project. Code references from the chosen standard should be used consistently within architectural plans.

Note 2: The 1998 "[Fair Housing Act Design Manual](#)", is available on-line and provides additional guidance.

C. Parking

City of Scottsdale Zoning Ordinance, Article IX. "Parking and Loading Requirements of the Zoning Ordinance" specifies requirements for accessible parking spaces and vehicle clearance heights.

Note: The ADA Stds have parking requirements which must also be incorporated into the design.

ACCESSIBLE FACILITIES ON PRIVATE PROPERTY

12-1.200

At least one accessible pedestrian route shall be provided to each accessible building and facility entrance from: 1. Accessible parking spaces and accessible passenger loading zones, 2. Public streets and sidewalks, 3. and from public transportation stops.

Note 1: Design Submittal: The accessible routes should be clearly identified on both architectural and civil site plans. Accessible route notes should indicate/identify landing dimensions, building finish floor elevation, entrance and exit door landing elevation, cross slope, running slope, grade breaks, turning spaces, ramp slopes, and clear width. References to typical enlarged details should be provided where applicable.

Note 2: Accessible Route Marking: On-site striping of accessible routes, such as striping of pedestrian routes through parking lots to building entrances is not a COS requirement.

Note 3: In locations where changes in elevation are critical to understanding the slopes of accessible routes, the specific running and cross slopes should be noted where grade changes occur.

Note 4: The 1998 Fair Housing Act Design Manual, the 2010 ADA Stds, and the 2015 IBC Commentary provide guidance on accessible pedestrian building entrances and accessible routes.

BUILDING ENTRANCES

12-1.201

Entrances and exits from buildings are required by building codes to have landings which are at the same elevation as the interior finished floors. These exterior landings are subject to a limiting slope of 2% maximum in all directions. Where accessible routes overlap building entrances, the portion of the route that overlaps the landing shall be 2% maximum in all directions.

Note: Identifying (graphically labeling) the egress and entrance doors along the building perimeter, and noting these locations on both civil and architectural site plans can provide critical information on the connection point between onsite accessible routes and the building entrances.

WALKING SURFACES

12-1.202

Accessible pedestrian surfaces shall be firm, stable and slip resistant. Vertical changes in elevation between $\frac{1}{4}$ inch and $\frac{1}{2}$ inch along accessible routes shall be beveled, and any horizontal offsets limited to a maximum $\frac{1}{2}$ inch gap. All material types other than asphalt and concrete are subject to COS staff approval.

Note: Brick pavers, stone, stamped asphalt, or stamped concrete, designed to have domed or beveled tops should not be used along accessible pedestrian routes. Adjacent areas which are not a part of the accessible route can be used for these decorative purposes.

CURB RAMP DESIGN ON-SITE

12-1.203

Within accessible on-site pedestrian routes, curb ramps shall conform to the COS Supplements to Maricopa Association of Governments (MAG) Specifications and Details, and ADA Stds. Alternative designs are permitted, such as using the standard curb ramp details except for DWS and are subject to COS staff approval.

DETECTABLE WARNING SURFACES ON-SITE

12-1.204

Detectable warning surfaces (DWS) are not intended to be used within developed commercial property unless a specific need can be justified, such as high-traffic areas

with pedestrian crossings. Use of DWS at high-traffic areas within site boundaries may be approved by COS staff on a case-by-case basis.

On-site DWS in the Environmentally Sensitive Land areas shall be a color equivalent to Sherman Williams Paint 'Enduring Bronze' (SW 7055).

Note 1: DWS are intended as a warning for blind/low vision pedestrians who are approaching a street intersection which has a pedestrian street crossing. Pedestrian crossings at typical parking lots and on-site drives do not generally require DWS. Pedestrians who are blind or with low vision can benefit from other wayfinding cues. Signage and pavement marking can be useful at high pedestrian-use crossings to warn vehicle drivers of pedestrians, in lieu of installing DWS.

Note 2: For DWS designed on public right-of-ways, see Section 12-1.301. All DWS on curb ramps or sloped surfaces at pedestrian street crossings within the public rights-of-way shall also comply with the required contrast between the DWS and the adjacent walking surface of light-on-dark or dark-on-light.

DRIVEWAY ACCESS TO PUBLIC AND PRIVATE STREETS

12-1.205

Driveway design shall comply with the COS Supplements to MAG Specifications and Details. Installation of DWS at driveway-to-street connections are subject to COS staff approval.

Note 1: Private developments with privately owned streets must meet the requirements of the Design Standards & Policies Manual (DSPM).

Note 2: Where vehicular drives on private property connect to public rights-of-way, commercial driveways and streets with yield or stop control may be provided with DWS when approved by COS staff. Refer to the "advisory" notes in PROWAG 2011 section R208.1 for additional guidance.

ACCESSIBLE PARKING SPACES

12-1.206

A. Accessible parking spaces

Accessible parking must comply with the ADA Stds and Article IX of the Zoning Ordinance.

B. Parking Signage

Accessible parking spaces shall include signs in accordance with COS Supplements to MAG Specifications and Details, and ADA Stds.

Note: Accessible sign and sign post details can be found within the COS website, as standard detail 2124. Also see the Figure 12-1.1 "Preferred Accessible Parking Spaces".

C. Accessible Parking Space Configuration

1. For outdoor (non-parking garage) covered and non-covered parking,
2. Figure 12-1.1 is the preferred configuration of accessible parking spaces.
3. Parking garages: see Article IX of the Zoning Ordinance.
4. Restriping of existing parking lots requires staff approval.
5. The International Symbol of Accessibility is an ISO standard and cannot be altered. Use of the Symbol shall be displayed and applied as depicted in ADA Stds 703.7.2.

6. Note 1: Article IX of the Zoning Ordinance contains numerous provisions related to parking. Section 9.105 can be an effective starting point for understanding parking requirements specific to parking garages.
7. Note 2: The [ADA Access Board](#) provides 'Guidance' on the International Symbol of Accessibility:

PASSENGER LOADING AND DRIVE THROUGH FACILITIES

12-1.207

A. Drive-through facilities

Drive-through facilities shall have a vertical clearance of 98 inches.

B. Passenger loading zones

Passenger loading zones and passenger loading facilities shall comply with sections 209 and 503 of the ADA Stds.

Note 1: The passenger loading area is to be provided with color, texture, or surface marking to indicate it is for passenger loading.

Note 2: Where passenger loading areas without curbing are designed to transition to adjacent sidewalks using slopes <5%, a buffer strip, plantings, or bollards should be considered to restrict vehicles from encroaching onto the pedestrian sidewalk.

ONGOING BARRIER REMOVAL

12-1.208

Titles II and III of the ADA require ongoing barrier removal. Projects specifically targeted as barrier removal may require a building permit.

Note 1: See ADA Stds section 101.2. The U.S. Department of Justice provides information and a checklist for readily achievable barrier removal. Refer to www.ada.gov and "ADA Title III Regulations," especially Section 36.304.

Note 2: Our ADA Resource page on the COS Website contains helpful information on barrier removal obligations and resources.

ALTERATIONS

12-1.209

Both the 2015 IEBC and the 2010 ADA Stds have requirements for alterations to existing buildings and facilities. For alterations affecting primary function of the building, up to 20 percent of the total cost of an alteration affecting the primary function shall be used towards providing an accessible route to that area and to the toilet rooms.

Note: See IEBC section 410.

ACCESSIBILITY IN PUBLIC RIGHTS-OF-WAYS AND EASEMENTS FOR PUBLIC ACCESS

12-1.300

All development within the public right-of-way and easements that effect pedestrian circulation and use shall be designed and constructed in compliance with the 2010 ADA Stds, the extent feasible. The U.S. Access Board (Access Board) Proposed Accessibility Guidelines for Pedestrian Facilities in the Public Right-of-Way (PROWAG) dated July 26, 2011 may be used as an alternate where applicable.

Note: Also refer to:

- A. [National Cooperative Highway Research Program \(NCHRP\) Accessible Pedestrian Signals, Synthesis and Guide to Best Practice.](#)

- B. [Pedestrian and Bicycle Information Center](#)
- C. Chapter 5 of this manual.
- D. Additional guidance including comparison between ADA Stds and PROWAG can be found on the [Access Boards](#) website.

DETECTABLE WARNING SURFACES IN PUBLIC RIGHTS-OF-WAY 12-1.301

Detectable warning surfaces (DWS) shall be provided at right-of-way street intersections as required in the 2011 PROWAG. DWS design for specific geometry of the in accordance with COS Supplements to MAG Specifications and Details. Product substitutions are subject to COS staff approval.

Detectable warning surfaces (DWS) in the Environmentally Sensitive Land Areas shall be a color equivalent to Sherman Williams Paint 'Enduring Bronze' (SW 7055). Curb ramps and/or sidewalk portions immediately adjacent to detectable warning surfaces shall contrast with the DWS, either light on dark, or dark on light.

SITE ACCESS 12-1.302

On-site pedestrian access from right-of-way and easements for public access shall be provided in accordance with PROWAG, and Chapter 2 and Section 5.8 of this manual.

MEDIANS 12-1.303

Medians constructed to act as a Pedestrian Refuge shall have detectable warnings on both sides of the median at the crosswalk. Refer to this manual, PROWAG and COS Supplements to MAG Specifications and Details.

Note: Pedestrian Refuge per PROWAG R305.2.4 less than 6' in length shall not have DWS.

SIGNALS 12-1.304

Information on accessible pedestrian signals is available in the 2009 Manual on Uniform Traffic Control Devices (MUTCD) <http://mutcd.fhwa.dot.gov>

A. Accessible Pedestrian Signals

Accessible Pedestrian Signals may be requested by citizens who need accommodation.

B. Pedestrian Push Buttons

Refer to Section 5-4 of this manual, PROWAG, and MUTCD.

TRANSIT STOPS 12-1.305

All developed or redeveloped transit stops must comply with applicable provisions of the ADA, PROWAG, MAG Standard Detail No. 230, COS Supplements to MAG Specifications and Details (Detail No. 2232), and other "best practice" reference documents. All transit stops with an accessible pedestrian route shall incorporate the following elements referenced in Section 5-6 of this manual:

- A. Accessibility
- B. Benches
- C. Shelters
- D. Bus Stop Signs
- E. Sign Clearance

PUBLIC PARKS AND TRAILS

12-1.306

All walkways leading to, into and throughout sporting and recreation areas must be ADA compliant unless to do so would fundamentally alter the nature of the facility or activity. In addition, public trails shall comply with Section 8-3 of this manual.

CONSTRUCTION ACTIVITY

12-1.400

An accessible pedestrian route in the public rights-of-way shall be maintained during construction. For on-site construction, an accessible pedestrian route shall be maintained through or around the construction to areas unaffected by the construction. The route through the construction should replicate as close as possible the existing route.

When providing community notification of construction, include methods to alert residents with possible sensory impairments.

If the project impacts a bus stop, the permit holder shall create a temporary bus stop, with comparable amenities, if feasible. The temporary bus stop is subject to the Transportation Department Director or designee's approval.

Refer to Section 5-2 of this manual for details on barricade plans, community notification and temporary bus stops.

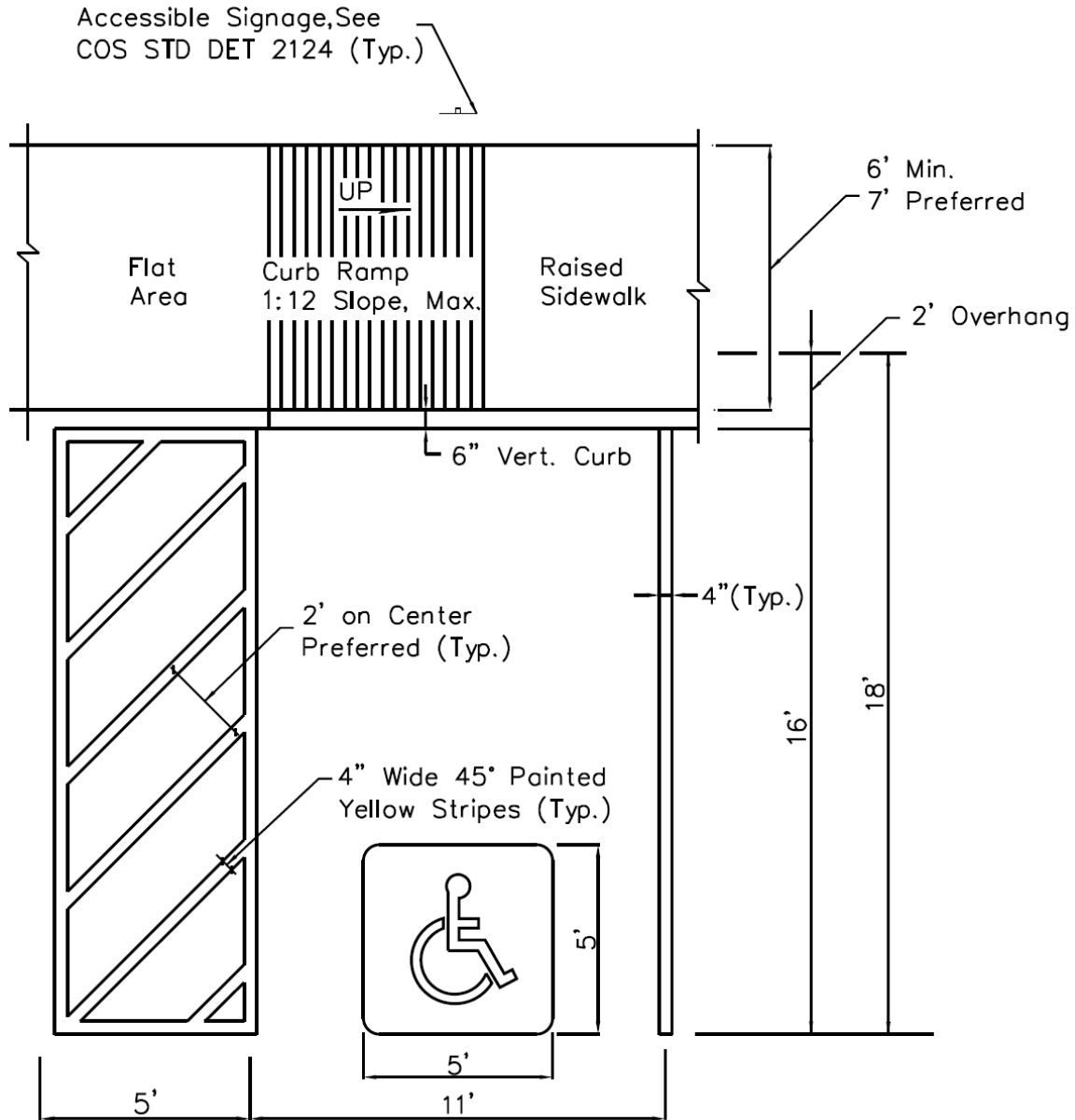

A. SIDEWALK OR PREPARED WALKWAY AS RAISED SIDEWALK
 FIGURE 12-1.1 PREFERRED ACCESSIBLE PARKING SPACES

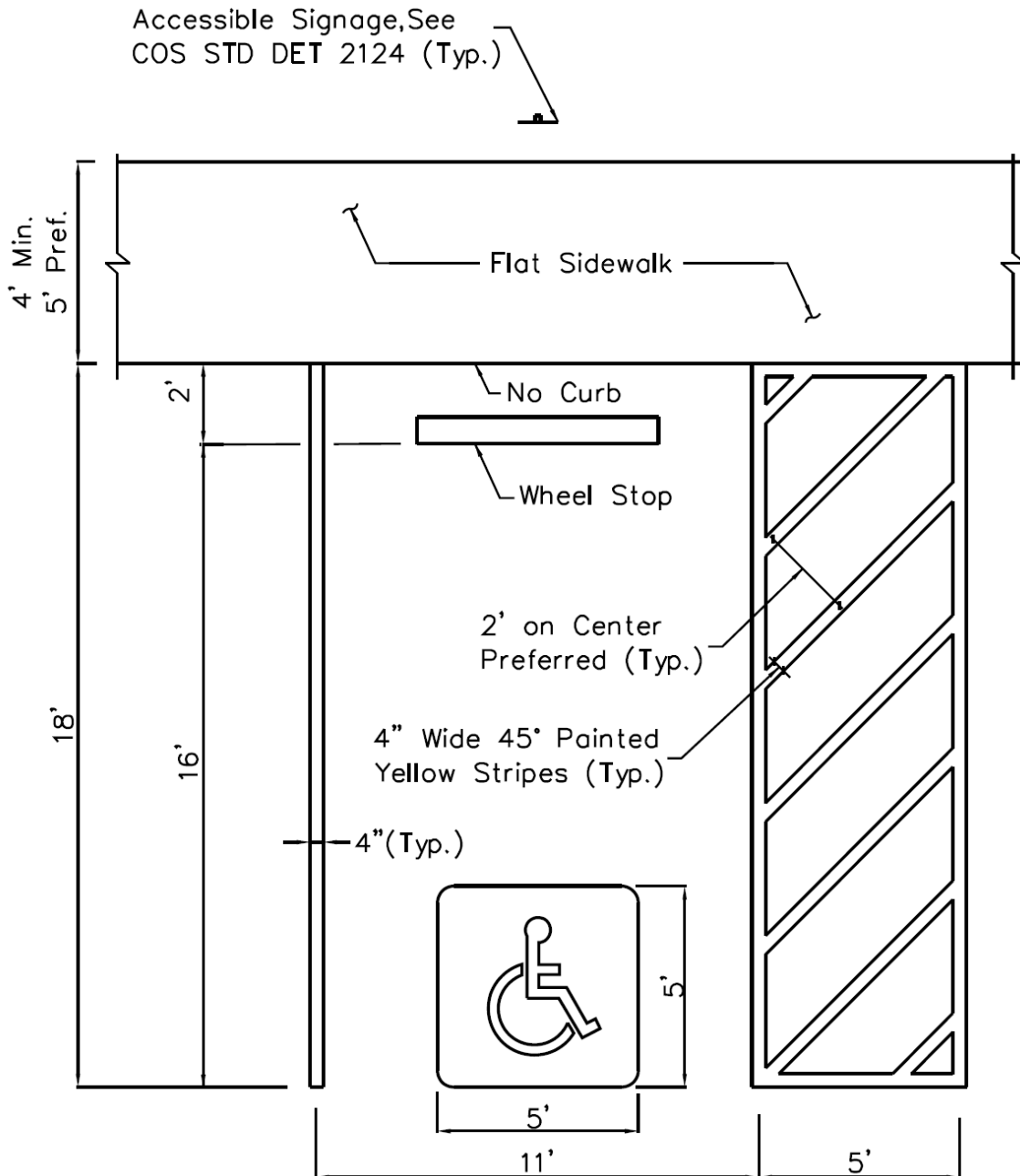

B. SIDEWALK OR PREPARED WALKWAY AT SAME LEVEL AS PARKING

FIGURE 12-1.1 PREFERRED ACCESSIBLE PARKING SPACES

NOTES TO FIGURE 12-1.1 PREFERRED ACCESSIBLE PARKING SPACES

A. ACCESS AISLES

1. Dimension is a fixed 5' width, by the full parking stall depth.
2. Slope of access aisles shall not exceed 2% in any direction.
3. Striping color shall be yellow, 4" stroke, painted in a diagonal pattern 24" on center, with a single horizontal stripe at the rear end of the aisle.
4. Access aisle shall transition to the adjacent parking stall(s) and the adjacent accessible route, at the same elevation.

B. CURB RAMPS FROM ACCESS AISLES

1. Where curb ramps connect parking access aisles to raised sidewalks, curb ramps shall be installed in the sidewalk and not within the access aisle.
2. Curb ramps shall be designed per COS Standard details.

C. ACCESSIBLE PARKING STALL

1. Stall dimension is a fixed 11' width, by the full parking stall depth.
2. Slope of parking stall shall not exceed 2% in any direction.
3. Striping color shall be white, 4" stroke, for the line adjacent to regular parking space.

D. INTERNATIONAL SYMBOL OF ACCESSIBILITY WITHIN PARKING STALL

1. The symbol shall be surrounded with a square border with a dimension of 5' x 5'.
2. Color requirements:
 - a. Symbol: White
 - b. Square Border: White or Yellow
 - c. Background: Blue or no color.

E. PARKING SIGNAGE

1. Signs for the accessible parking stalls shall be per Standard Detail 2124.
2. The bottom of the sign shall be 60" minimum above the parking surface.
3. One sign shall be installed at the head of each parking stall beyond any vehicle overhang.
4. Signs and posts shall not encroach into or reduce the accessible route width.

F. ACCESSIBLE ROUTES AT HEAD OF PARKING

1. Where an accessible route passes in front of parked vehicles, a 4' minimum width of sidewalk or route shall be maintained beyond vehicle bumpers.
2. Wheel stop curbs, bollards, curbs with landscaping, or sidewalk curbs shall be used to prevent the reduction of the accessible route width to less than 4'.

ACRONYMS & ABBREVIATIONS

This section provides a comprehensive listing of the acronyms and abbreviations used in the Design Standards & Policies Manual.

Section A&A-1

ACRONYMS AND ABBREVIATIONS

A&A-1

TABLE OF CONTENTS

A&A-1.TOC

SECTIONS

GENERAL	000	M	1400
#	100	N	1500
A	200	O	1600
B	300	P	1700
C	400	Q	1800
D	500	R	1900
E	600	S	2000
F	700	T	2100
G	800	U	2200
H	900	V	2300
I	1000	W	2400
J	1100	X	2500
K	1200	Y	2600
L	1300	Z	2700

GENERAL

The acronyms and abbreviations contained in the Design Standards & Policies Manual are listed as a general reference and provided in alphabetical order.

#

(None)

A

AASHTO	American Association of State Highway & Transportation Officials
ABC	Aggregate Base Course
ACP	asbestos cement pipe
ADA	Americans with Disabilities Act
ADAAG	Americans with Disabilities Act Standards for Accessible Design
ADEQ	Arizona Department of Environmental Quality
ADOT	Arizona Department of Transportation
ADT	average daily trips
ADWR	Arizona Department of Water Resources
AFF	above finish floor
ALTA	American Land Title Association
amp	ampere
Amps	amperage
ANSI	American National Standards Institute
APLS	Arizona Professional Land Surveyors
APS	Arizona Public Service
ARS or A.R.S.	Arizona Revised Statutes
ASCE	American Society of Civil Engineers
ASSHTO	American Association of State Highway and Transportation Officials
ASTM	American Society for Testing Materials
ATSSA	American Traffic Safety Services Association
AUCC	Arizona Utility Coordinating Committee
AVs	Air Relief Valves
AWG	American wire gauge
AWWA	American Water Works Association
AZPDES	Arizona Pollutant Discharge Elimination System

B

BCR	beginning of curb return
BFE	Base Flood Elevation

C

A&A.000

A&A.100

A&A.200

A&A.300

A&A.400

CAD	Computer Aided Drafting / Design
CAP	Central Arizona Project
CBD	Central Business District
CC&Rs	Conditions, Covenants, & Restrictions
CCTV	closed circuit television
CD	Compact Disc
cfs	cubic feet per second
CIP	Capital Improvement Plan
city	City of Scottsdale
CLSM	controlled low strength material
C of O	Certificate of Occupancy
Condo	condominium
COS	City of Scottsdale
CPM	Capital Project Management
CPSC	U.S. Consumer Products Safety Commission
CUP	Conditional Use Permit
CWA	Clean Water Act

D

A&A.500

DDC	Distribution Design Consultant
d/D	depth to diameter ratio
DIP	ductile iron pipe
DP	Development Plan
DRB	Development Review Board
DSPM	Design Standards & Policies Manual
DU/ac	dwelling unit per acre
DVD	Digital Versatile/Video Disc (recordable and rewriteable)

E

A&A.600

EB	east bound
ECR	end of curb return
EPA	United States Environmental Protection Agency
ESL	Environmentally Sensitive Lands
ESL zoning district	Environmentally Sensitive Lands (ESL) zoning district
ESL district	Environmentally Sensitive Lands (ESL) zoning district
ESL area	Geographic part of COS planned for the ESL zoning district
EVAC	East Valley Asphalt Committee
EVSS	Emergency Vapor Scrubber Systems

F

A&A.700

FAR	floor area ratio
FCDMC	Flood Control District of Maricopa County
FEMA	Federal Emergency Management Agency

ACRONYMS AND ABBREVIATIONS

A&A

FHWA	Federal Highway Administration
FIRM	Flood Insurance Rate Map
fps	feet per second
ft/ft	foot per feet also foot/feet

G

A&A.800

G&A	Green and Ampt
GLO	Government Land Office
gpcpd	gallons per capita per day
gpd	gallons per day
gpm	gallons per minute

H

A&A.900

HAG	Highest Adjacent Natural Grade
HCM	Highway Capacity Manual
HD	Hillside District (zoning district)
HID	high intensity discharge
HUD	United States Department of Housing and Urban Development
HVAC	Heating, Ventilation and Air Conditioning

I

A&A.1000

IES	Illuminating Engineering Society
IFC	International Fire Code
IMSA	International Municipal Signal Association
IPEMA	International Play Equipment Manufacturers Association
ITE	Institute of Transportation Engineers
ITS	Intelligent Transportation System

J

A&A.1100

(None)

K

A&A.1200

(None)

L

A&A.1300

LED	light emitting diode
LOS	Level of Service
LT	left turn

M

A&A.1400

MAG	Maricopa Association of Governments
-----	-------------------------------------

MCESD	Maricopa County Environmental Services Department
mil	millimeter
MOAS	Manual of Approved Signs
mph	miles per hour
MRCDD	Mechanical Room Controller Device
MTSP	Master Transportation Systems Plan
MUTCD	Manual on Uniform Traffic Control Devices

N

A&A.1500

NACTO	National Association of City Transportation Officials
NAOS	natural area open space
NAVD	North America Vertical Datum
NAVD 88	North America Vertical Datum of 1988
NAVD 1988	North America Vertical Datum of 1988
NB	north bound
NCHRP	National Cooperative Highway Research Program
NFPA	National Fire Protection Association
NOAA	National Oceanic and Atmospheric Administration
NOI	Notice of Intent
NOT	Notice of Termination
NPSI	National Playground Safety Inspector
NRCS	Natural Resources Conservation Service
NSF	National Sanitation Foundation
NSPS	National Society of Professional Surveyors
NTMP	Neighborhood Traffic Management Program

O

A&A.1600

(None)

P

A&A.1700

PC	point of curvature
PDF	portable document format (file format)
PI	Point of Intersection
POTW	Publicly Owned Treatment Works
PP	Preliminary Plat
PRD	Planned Residential Development Zoning District
PRV	pressure reducing valve
psi	pounds per square inch
PT	point of tangent
PUE	Public Utility Easement
PVC	polyvinyl chloride pipe
PWR	permission to work in the right-of-way

Q

QPL	Qualified Products List
Q ₁₀₀	100-year peak discharge in channel or wash

A&A.1800

R

RFE	Regulatory Flood Elevation
ROSS	Regional Off-Street System Plan
ROW	right-of-way
RPMs	raised pavement markers
RT	right turn
R1-	Single-family Residential Zoning District

A&A.1900

S

SA	Staff Approval
SAP	Speed Awareness Program
SB	Senate Bill
SB	south bound
SD	storm drain
SES	service entrance section
SFHA	Special Flood Hazard Area
SM	Select Material
SN	Structural Number
spp.	species
sq.ft.	square foot
SRC	Scottsdale Revised Code
SRP	Salt River Project
SRVWUA	Salt River Valley Water Users Association
SS	sanitary sewer
SSA	Arizona State Standard Attachment
STED	Scottsdale Traffic Engineering Division
SU	Single Unit Truck
SWPPP	Stormwater Pollution Prevention Plan

A&A.2000

T

TIMA	Transportation Impact Mitigation Analysis
TRB	Transportation Research Board
TS	traffic signalization/signing/markings

A&A.2100

U

UP	Use Permit
UPS	Uninterrupted Power Supplies

A&A.2200

USACE	United States Army Corps of Engineers
USDA	United States Department of Agriculture
USDOT	United States Department of Transportation
USTA	United States Tennis Association

V

A&A.2300

VAV or V.A.V.	variable air volume
VCP	vitriified clay pipe
VFD or V.F.D.	variable frequency drive
VMB	variable message board
V.N.E.	vehicular non-access easement
vpd	vehicles per day

W

A&A.2400

WB	west bound
----	------------

X

A&A.2500

(None)

Y

A&A.2600

(None)

Z

A&A.2700

ZN	Zoning
----	--------